

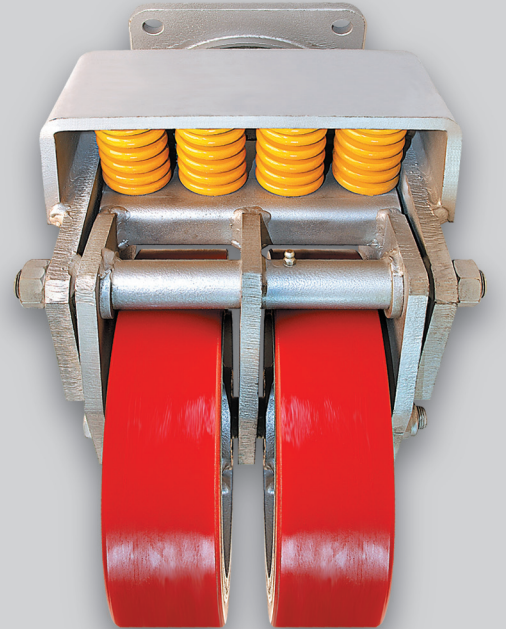

AĞIR

SANAYİ TAŞIMA
RULETLERİ



90-5000kg Taşıma Kapasitesi

[İÇİNDEKİLER]

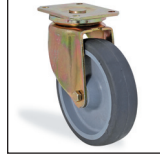

4100 Serisi 1-23



4300 Serisi 24-37

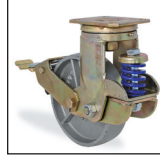

AD4300 Serisi (Amortisörlü) 38-79

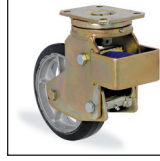

AY4300 Serisi (Amortisörlü) 80-100



4400 Serisi 101-127



5100 Serisi 128-145



AY5100 Serisi (Amortisörlü) 146-166



5700 Serisi 167-174



6700 Serisi 175-186





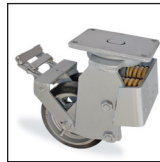

















AD6700 Serisi (Amortisörlü) 187-189









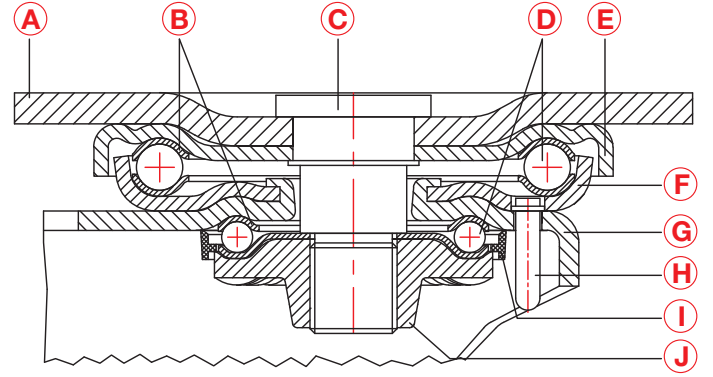

AY6700 Serisi (Amortisörlü) 190-194

RULET KODLAMA SİSTEMİ









AY	43	02	D	2	O	R	150	F04	K	T
ÖN KOD	SERİ KODU	BAĞLANTI TİPİ	GÖVDE CİNSİ	SIRT TİPİ	SIRT MALZEMESİ	YATAK TİPİ	TEKER ÇAP (Ømm)	FREN SİSTEMİ	YAY	İLAVE BİLGİ HANESİ
AY AMORTİSÖR (YATAY)	41	00 DELİKLİ 	A POLİAMİD 66	1 U PROFİLLİ SIRT (F14-MARKET TİPİ)	A POLİAMİD 66	A	080	F04 	Y 	T 
AD AMORTİSÖR (DİKEY)	43	01 CİVATA 	B İSİYA DAYANIKLI BAKALİT	2 DERİN RADÜSLÜ (OVAL) SIRT TİPİ	B İSİYA DAYANIKLI BAKALİT	B BURÇ YATAKLAMAŞI GÖVDENİN KENDİ	100	F09 	YEŞİL YAY	SAC JANT KAPAKLI
S PASLANMAZ	44	02 TABLA 	C TAKVİYELİ PP	3 ÜÇ KANALLI SIRT FORMLU (MARKET TİPİ)	C PLASTİK (P.V.C.)	C İSİYA DAYANIKLI BURÇ	125	F17 	M 	
	51	05 PİM 	D PİK (DÖKÜM)	4 U PROFİLLİ GÖVDEDEN BOMBELİ (F16-MARKET TİPİ)	D PİK (DÖKÜM)	D	150	F18 	MAVİ YAY	
	57	07 SABİT MAŞA 	E		E GRİ LASTİK	E	160	F20 	K 	
	67	15 BORULU 	F POLİAMİD 6 KÜTÜK		F POLİAMİD 6 KÜTÜK	F	200		KIRMIZI YAY	
		17 SOKET 	G		G	G	220		S 	
		18 LAMA 	H POLİKARBONAT		H HAVALI LASTİK	H	250			
		25 AYARLI BAŞLIK (OYNAK) 	I		I	I	260			
		27 AYARLI BAŞLIK (SABİT) 	K KAMALON		K	K	270			
			L		L SİYAH LASTİK	L	300			
			M POLİPROPİLEN		M POLİPROPİLEN	M DİZME MİSKET BİLYALI YATAKLAMA	350			
			N TAKVİYELİ POLİAMİD 6		N TAKVİYELİ POLİAMİD 6	N	380			
			O		O DÖKME POLİÜRETAN	O				
			P POLİAMİD 6		P POLİAMİD 6	P POLİAMİD BURÇLU YATAKLAMA				
			R AĞIR TİP		R MAVİ LASTİK	R BİLYA RULMANLI YATAKLAMA				
			S SAC		S YARI HAVALI (DUBLEKS) LASTİK	S MASURALI YATAKLAMA				
			T		T TERMOELASTİK LASTİK	T				
			U		U ENJEKSİYON BASKI POLİÜRETAN	U				
			V		V VULKANİZE LASTİK	V				
			Y		Y AĞIR TİP VULKANİZE LASTİK	Y				
			Z ALAŞIMLI ALÜMİNYUM		Z	Z				

- A:** OYNAK TABLA
B: CK60 MALZEMEDEN SERTLEŞTİRİLMİŞ BİLYA YATAĞI
C: TABLA BAĞLANTI CİVATASI
D: KÜRESEL METAL TANE BİLYALAR
E: TABLA ÇANAĞI
F: MAŞA ÇANAĞI
G: OYNAK RULET MAŞASI
H: GRESÖRLÜK
I: BİLYA MUHAFAZA TOZLUK
J: DÖVME ALT BİLYA ÇANAĞI









**BBC****ISIYA DAYANIKLI BAKALİT TEKER PİRİNÇ BURÇLU (+250°C)**

KOD NO	 mm	 mm	 mm	 mm	 mm	 mm	 mm	 kg
4102 BBC 080	80	30	117	40	105x80	80x60	12x9	120
4102 BBC 100	100	35	144	46.5	140x110	105x80	13.5x11	150
4102 BBC 125	125	40	175	48	140x110	105x80	13.5x11	300
4102 BBC 150	150	45	206	52	140x110	105x80	13.5x11	450
4102 BBC 200	200	50	247	58	140x110	105x80	13.5x11	600









**CTB****GÜÇLENDİRİLMİŞ POLİAMİD KASNAK ÜZERİ TERMOELASTİK GRİ LASTİK KAPLAMA BURÇLU**

KOD NO	 mm	 mm	 mm	 mm	 mm	 mm	 mm	 kg
4102 CTB 080	80	30	117	40	105x80	80x60	12x9	90
4102 CTB 100	100	35	144	46.5	140x110	105x80	13.5x11	120
4102 CTB 125	125	40	175	48	140x110	105x80	13.5x11	150
4102 CTB 150	150	45	206	52	140x110	105x80	13.5x11	180
4102 CTB 200	200	50	247	58	140x110	105x80	13.5x11	250











CTB		GÜÇLENDİRİLMİŞ POLİAMİD KASNAK ÜZERİ TERMOELASTİK GRİ LASTİK KAPLAMA BURÇLU							
KOD NO									
	mm	mm	mm	mm	mm	mm	mm	mm	kg
4102 CTB 080 F18	80	30	117	40	121	105x80	80x60	12x9	90
4102 CTB 100 F18	100	35	144	50.5	163	140x110	105x80	13.5x11	120
4102 CTB 125 F18	125	40	175	51	166	140x110	105x80	13.5x11	150
4102 CTB 150 F18	150	45	206	56.5	165	140x110	105x80	13.5x11	180
4102 CTB 200 F18	200	50	247	60	162	140x110	105x80	13.5x11	250











YÖN KİLİTLİ

CTB		GÜÇLENDİRİLMİŞ POLİAMİD KASNAK ÜZERİ TERMOELASTİK GRİ LASTİK KAPLAMA BURÇLU							
KOD NO									
	mm	mm	mm	mm	mm	mm	mm	mm	kg
4102 CTB 100 F17	100	35	144	46.5	145	140x110	105x80	13.5x11	120
4102 CTB 125 F17	125	40	175	48	145	140x110	105x80	13.5x11	150
4102 CTB 150 F17	150	45	206	52	145	140x110	105x80	13.5x11	180
4102 CTB 200 F17	200	50	247	58	145	140x110	105x80	13.5x11	250











CTR		GÜÇLENDİRİLMİŞ POLİAMİD KASNAK ÜZERİ TERMOELASTİK GRİ LASTİK KAPLAMA RULMANLI							
KOD NO									
	mm	mm	mm	mm	mm	mm	mm	mm	kg
4102 CTR 100	100	35	144	46.5	140x110	105x80	13.5x11		120
4102 CTR 125	125	40	175	48	140x110	105x80	13.5x11		150
4102 CTR 150	150	45	206	52	140x110	105x80	13.5x11		180
4102 CTR 200	200	50	247	58	140x110	105x80	13.5x11		250











CTR		GÜÇLENDİRİLMİŞ POLİAMİD KASNAK ÜZERİ TERMOELASTİK GRİ LASTİK KAPLAMA RULMANLI							
KOD NO									
	mm	mm	mm	mm	mm	mm	mm	mm	kg
4102 CTR 100 F18	100	35	144	50.5	163	140x110	105x80	13.5x11	120
4102 CTR 125 F18	125	40	175	51	166	140x110	105x80	13.5x11	150
4102 CTR 150 F18	150	45	206	56.5	165	140x110	105x80	13.5x11	180
4102 CTR 200 F18	200	50	247	60	162	140x110	105x80	13.5x11	250











YÖN KİLİTLİ

CTR		GÜÇLENDİRİLMİŞ POLİAMİD KASNAK ÜZERİ TERMOELASTİK GRİ LASTİK KAPLAMA RULMANLI							
KOD NO									
	mm	mm	mm	mm	mm	mm	mm	mm	kg
4102 CTR 100 F17	100	35	144	46.5	145	140x110	105x80	13.5x11	120
4102 CTR 125 F17	125	40	175	48	145	140x110	105x80	13.5x11	150
4102 CTR 150 F17	150	45	206	52	145	140x110	105x80	13.5x11	180
4102 CTR 200 F17	200	50	247	58	145	140x110	105x80	13.5x11	250









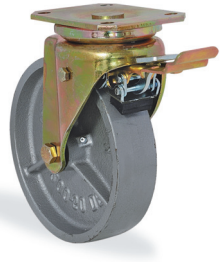

DDB		DÖKÜM TEKER BURÇLU							
KOD NO									
	mm	mm	mm	mm	mm	mm	mm	mm	kg
4102 DDB 055	55	25	87	26	79x70	60x50	8.3x9.6		150
4102 DDB 080	80	30	117	40	105x80	80x60	12x9		200
4102 DDB 100	100	35	144	46.5	140x110	105x80	13.5x11		400
4102 DDB 125	125	40	175	48	140x110	105x80	13.5x11		500
4102 DDB 150	150	45	206	52	140x110	105x80	13.5x11		800
4102 DDB 170	170	45	216	52	140x110	105x80	13.5x11		900
4102 DDB 200	200	50	247	58	140x110	105x80	13.5x11		1100











DDB		DÖKÜM TEKER BURÇLU							
KOD NO									
	mm	mm	mm	mm	mm	mm	mm	mm	kg
4102 DDB 055 F18	55	25	87	26	91	79x70	60x50	8.3x9.6	150
4102 DDB 080 F18	80	30	117	40	121	105x80	80x60	12x9	200
4102 DDB 100 F18	100	35	144	50.5	163	140x110	105x80	13.5x11	400
4102 DDB 125 F18	125	40	175	51	166	140x110	105x80	13.5x11	500
4102 DDB 150 F18	150	45	206	56.5	165	140x110	105x80	13.5x11	800
4102 DDB 200 F18	200	50	247	60	162	140x110	105x80	13.5x11	1100











DDB		DÖKÜM TEKER BURÇLU							
KOD NO									
	mm	mm	mm	mm	mm	mm	mm	mm	kg
4102 DDB 170 F09	170	45	216	52	144	140x110	105x80	13.5x11	900











YÖN KİLİTLİ

DDB		DÖKÜM TEKER BURÇLU							
KOD NO									
	mm	mm	mm	mm	mm	mm	mm	mm	kg
4102 DDB 100 F17	100	35	144	46.5	145	140x110	105x80	13.5x11	400
4102 DDB 125 F17	125	40	175	48	145	140x110	105x80	13.5x11	500
4102 DDB 150 F17	150	45	206	52	145	140x110	105x80	13.5x11	800
4102 DDB 170 F17	170	45	216	52	145	140x110	105x80	13.5x11	900
4102 DDB 200 F17	200	50	247	58	145	140x110	105x80	13.5x11	1100











DDR		DÖKÜM TEKER RULMANLI							
KOD NO									
	mm	mm	mm	mm	mm	mm	mm	mm	kg
4102 DDR 100	100	35	144	46.5	145	140x110	105x80	13.5x11	400
4102 DDR 125	125	40	175	48	145	140x110	105x80	13.5x11	500
4102 DDR 150	150	45	206	52	145	140x110	105x80	13.5x11	800
4102 DDR 200	200	50	247	58	145	140x110	105x80	13.5x11	1100











DDR		DÖKÜM TEKER RULMANLI							
KOD NO									
	mm	mm	mm	mm	mm	mm	mm	mm	kg
4102 DDR 100 F18	100	35	144	50.5	163	140x110	105x80	13.5x11	400
4102 DDR 125 F18	125	40	175	51	166	140x110	105x80	13.5x11	500
4102 DDR 150 F18	150	45	206	56.5	165	140x110	105x80	13.5x11	800
4102 DDR 200 F18	200	50	247	60	162	140x110	105x80	13.5x11	1100



YÖN KİLİTLİ

DDR		DÖKÜM TEKER RULMANLI							
KOD NO									
	mm	mm	mm	mm	mm	mm	mm	mm	kg
4102 DDR 100 F17	100	35	144	46.5	145	140x110	105x80	13.5x11	400
4102 DDR 125 F17	125	40	175	48	145	140x110	105x80	13.5x11	500
4102 DDR 150 F17	150	45	206	52	145	140x110	105x80	13.5x11	800
4102 DDR 200 F17	200	50	247	58	145	140x110	105x80	13.5x11	1100



DOR		DÖKÜM ÜZERİ DÖKME POLİÜRETAN KAPLAMA RULMANLI						
KOD NO								
	mm	mm	mm	mm	mm	mm	mm	kg
4102 DOR 080	80	30	117	40	105x80	80x60	12x9	200
4102 DOR 100	100	35	144	46.5	140x110	105x80	13.5x11	350
4102 DOR 125	125	40	175	48	140x110	105x80	13.5x11	450
4102 DOR 150	150	45	206	52	140x110	105x80	13.5x11	700
4102 DOR 200	200	50	247	58	140x110	105x80	13.5x11	1000











DOR		DÖKÜM ÜZERİ DÖKME POLİÜRETAN KAPLAMA RULMANLI							
KOD NO									
	mm	mm	mm	mm	mm	mm	mm	mm	kg
4102 DOR 080 F18	80	30	117	40	121	105x80	80x60	12x9	200
4102 DOR 100 F18	100	35	144	50.5	163	140x110	105x80	13.5x11	350
4102 DOR 125 F18	125	40	175	51	166	140x110	105x80	13.5x11	450
4102 DOR 150 F18	150	45	206	56.5	165	140x110	105x80	13.5x11	700
4102 DOR 200 F18	200	50	247	60	162	140x110	105x80	13.5x11	1000











YÖN KİLİTLİ

DOR		DÖKÜM ÜZERİ DÖKME POLİÜRETAN KAPLAMA RULMANLI							
KOD NO									
	mm	mm	mm	mm	mm	mm	mm	mm	kg
4102 DOR 100 F17	100	35	144	46.5	145	140x110	105x80	13.5x11	350
4102 DOR 125 F17	125	40	175	48	145	140x110	105x80	13.5x11	450
4102 DOR 150 F17	150	45	206	52	145	140x110	105x80	13.5x11	700
4102 DOR 200 F17	200	50	247	58	145	140x110	105x80	13.5x11	1000









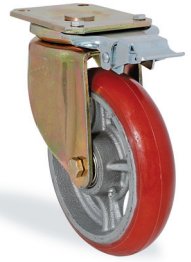

D2OR		DÖKÜM ÜZERİ OVAL DÖKME POLİÜRETAN KAPLAMA RULMANLI						
KOD NO								
	mm	mm	mm	mm	mm	mm	mm	kg
4102 D2OR 080	80	30	117	40	105x80	80x60	12x9	200
4102 D2OR 100	100	35	144	46.5	140x110	105x80	13.5x11	350
4102 D2OR 125	125	40	175	48	140x110	105x80	13.5x11	450
4102 D2OR 150	150	45	206	52	140x110	105x80	13.5x11	700
4102 D2OR 200	200	50	247	58	140x110	105x80	13.5x11	1000









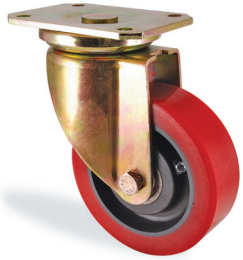

D2OR
DÖKÜM ÜZERİ OVAL DÖKME POLİÜRETAN KAPLAMA RULMANLI

KOD NO	 mm	 mm	 mm	 mm	 mm	 mm	 mm	 mm	 kg
4102 D2OR 080 F18	80	30	117	40	121	105x80	80x60	12x9	200
4102 D2OR 100 F18	100	35	144	50.5	163	140x110	105x80	13.5x11	350
4102 D2OR 125 F18	125	40	175	51	166	140x110	105x80	13.5x11	450
4102 D2OR 150 F18	150	45	206	56.5	165	140x110	105x80	13.5x11	700
4102 D2OR 200 F18	200	50	247	60	162	140x110	105x80	13.5x11	1000











YÖN KİLİTLİ
D2OR
DÖKÜM ÜZERİ OVAL DÖKME POLİÜRETAN KAPLAMA RULMANLI

KOD NO	 mm	 mm	 mm	 mm	 mm	 mm	 mm	 mm	 kg
4102 D2OR 100 F17	100	35	144	46.5	145	140x110	105x80	13.5x11	350
4102 D2OR 125 F17	125	40	175	48	145	140x110	105x80	13.5x11	450
4102 D2OR 150 F17	150	45	206	52	145	140x110	105x80	13.5x11	700
4102 D2OR 200 F17	200	50	247	58	145	140x110	105x80	13.5x11	1000







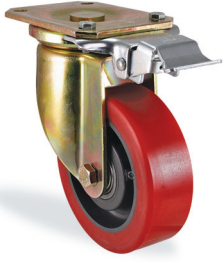

KOR
KAMALON ÜZERİ DÖKME POLİÜRETAN KAPLAMA RULMANLI

KOD NO	 mm	 mm	 mm	 mm	 mm	 mm	 mm	 mm	 kg
4102 KOR 100	100	40	144	46.5	140x110	105x80	13.5x11	350	
4102 KOR 125	125	50	175	48	140x110	105x80	13.5x11	450	
4102 KOR 150	150	50	206	52	140x110	105x80	13.5x11	700	
4102 KOR 160	160	50	202	61	140x110	105x80	13.5x11	800	
4102 KOR 200	200	50	247	58	140x110	105x80	13.5x11	1000	









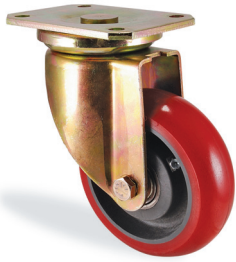

KOR
KAMALON ÜZERİ DÖKME POLİÜRETAN KAPLAMA RULMANLI

KOD NO	 mm	 mm	 mm	 mm	 mm	 mm	 mm	 mm	 kg
4102 KOR 100 F18	100	40	144	50.5	163	140x110	105x80	13.5x11	350
4102 KOR 125 F18	125	50	175	51	166	140x110	105x80	13.5x11	450
4102 KOR 150 F18	150	50	206	56.5	165	140x110	105x80	13.5x11	700
4102 KOR 160 F18	160	50	202	58	161	140x110	105x80	13.5x11	800
4102 KOR 200 F18	200	50	247	60	162	140x110	105x80	13.5x11	1000











YÖN KİLİTLİ

KOR		KAMALON ÜZERİ DÖKME POLİÜRETAN KAPLAMA RULMANLI							
KOD NO									
	mm	mm	mm	mm	mm	mm	mm	mm	kg
4102 KOR 100 F17	100	40	144	46.5	145	140x110	105x80	13.5x11	350
4102 KOR 125 F17	125	50	175	48	145	140x110	105x80	13.5x11	450
4102 KOR 150 F17	150	50	206	52	145	140x110	105x80	13.5x11	700
4102 KOR 160 F17	160	50	202	61	145	140x110	105x80	13.5x11	800
4102 KOR 200 F17	200	50	247	58	145	140x110	105x80	13.5x11	1000











K2OR		KAMALON ÜZERİ OVAL DÖKME POLİÜRETAN KAPLAMA RULMANLI							
KOD NO									
	mm	mm	mm	mm	mm	mm	mm	mm	kg
4102 K2OR 100	100	40	144	46.5	140x110	105x80	13.5x11	350	
4102 K2OR 125	125	50	175	48	140x110	105x80	13.5x11	450	
4102 K2OR 150	150	50	206	52	140x110	105x80	13.5x11	700	
4102 K2OR 160	160	50	202	61	140x110	105x80	13.5x11	800	
4102 K2OR 200	200	50	247	58	140x110	105x80	13.5x11	1000	



K2OR		KAMALON ÜZERİ OVAL DÖKME POLİÜRETAN KAPLAMA RULMANLI							
KOD NO									
	mm	mm	mm	mm	mm	mm	mm	mm	kg
4102 K2OR 100 F18	100	40	144	50.5	163	140x110	105x80	13.5x11	350
4102 K2OR 125 F18	125	50	175	51	166	140x110	105x80	13.5x11	450
4102 K2OR 150 F18	150	50	206	56.5	165	140x110	105x80	13.5x11	700
4102 K2OR 160 F18	160	50	202	58	161	140x110	105x80	13.5x11	800
4102 K2OR 200 F18	200	50	247	60	162	140x110	105x80	13.5x11	1000

YÖN KİLİTLİ

K2OR		KAMALON ÜZERİ OVAL DÖKME POLİÜRETAN KAPLAMA RULMANLI							
KOD NO									
	mm	mm	mm	mm	mm	mm	mm	mm	kg
4102 K2OR 100 F17	100	40	144	46.5	145	140x110	105x80	13.5x11	350
4102 K2OR 125 F17	125	50	175	48	145	140x110	105x80	13.5x11	450
4102 K2OR 150 F17	150	50	206	52	145	140x110	105x80	13.5x11	700
4102 K2OR 160 F17	160	50	202	61	145	140x110	105x80	13.5x11	800
4102 K2OR 200 F17	200	50	247	58	145	140x110	105x80	13.5x11	1000



DYZ		DÖKÜM ÜZERİ VULKANİZE LASTİK KAPLAMA RULMANLI						
KOD NO								
	mm	mm	mm	mm	mm	mm	mm	kg
4102 DYZ 080	80	30	117	40	105x80	80x60	12x9	90
4102 DYZ 100	100	35	144	46.5	140x110	105x80	13.5x11	140
4102 DYZ 125	125	40	175	48	140x110	105x80	13.5x11	180
4102 DYZ 150	150	45	206	52	140x110	105x80	13.5x11	200
4102 DYZ 170	170	45	216	52	140x110	105x80	13.5x11	240
4102 DYZ 200	200	50	247	58	140x110	105x80	13.5x11	350



DYZ		DÖKÜM ÜZERİ VULKANİZE LASTİK KAPLAMA RULMANLI							
KOD NO									
	mm	mm	mm	mm	mm	mm	mm	kg	
4102 DYZ 080 F18	80	30	117	40	121	105x80	80x60	12x9	90
4102 DYZ 100 F18	100	35	144	50.5	163	140x110	105x80	13.5x11	140
4102 DYZ 125 F18	125	40	175	51	166	140x110	105x80	13.5x11	180
4102 DYZ 150 F18	150	45	206	56.5	165	140x110	105x80	13.5x11	200
4102 DYZ 200 F18	200	50	247	60	162	140x110	105x80	13.5x11	350



DYZ		DÖKÜM ÜZERİ VULKANİZE LASTİK KAPLAMA RULMANLI							
KOD NO									
	mm	mm	mm	mm	mm	mm	mm	kg	
4102 DYZ 170 F09	170	45	216	52	144	140x110	105x80	13.5x11	240

YÖN KİLİTLİ

DYZ		DÖKÜM ÜZERİ VULKANİZE LASTİK KAPLAMA RULMANLI							
KOD NO									
	mm	mm	mm	mm	mm	mm	mm	kg	
4102 DYZ 100 F17	100	35	144	46.5	145	140x110	105x80	13.5x11	140
4102 DYZ 125 F17	125	40	175	48	145	140x110	105x80	13.5x11	180
4102 DYZ 150 F17	150	45	206	52	145	140x110	105x80	13.5x11	200
4102 DYZ 170 F17	170	45	216	52	145	140x110	105x80	13.5x11	240
4102 DYZ 200 F17	200	50	247	58	145	140x110	105x80	13.5x11	350



KYR		KAMALON KASNAK ÜZERİ VULKANİZE SİYAH LASTİK KAPLAMA RULMANLI						
KOD NO								kg
4102 KYR 100	100	40	144	46.5	140x110	105x80	13.5x11	140
4102 KYR 125	125	40	175	48	140x110	105x80	13.5x11	180
4102 KYR 150	150	45	206	52	140x110	105x80	13.5x11	200
4102 KYR 160	160	50	202	61	140x110	105x80	13.5x11	240
4102 KYR 200	200	50	247	58	140x110	105x80	13.5x11	350



KYR		KAMALON KASNAK ÜZERİ VULKANİZE SİYAH LASTİK KAPLAMA RULMANLI							
KOD NO								kg	
4102 KYR 100 F18	100	40	144	50.5	163	140x110	105x80	13.5x11	140
4102 KYR 125 F18	125	40	175	51	166	140x110	105x80	13.5x11	180
4102 KYR 150 F18	150	45	206	56.5	165	140x110	105x80	13.5x11	200
4102 KYR 160 F18	160	50	202	58	161	140x110	105x80	13.5x11	240
4102 KYR 200 F18	200	50	247	60	162	140x110	105x80	13.5x11	350

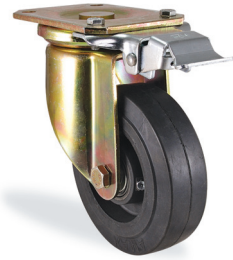

YÖN KİLİTLİ

KYR		KAMALON KASNAK ÜZERİ VULKANİZE SİYAH LASTİK KAPLAMA RULMANLI							
KOD NO								kg	
4102 KYR 100 F17	100	40	144	46.5	145	140x110	105x80	13.5x11	140
4102 KYR 125 F17	125	40	175	48	145	140x110	105x80	13.5x11	180
4102 KYR 150 F17	150	45	206	52	145	140x110	105x80	13.5x11	200
4102 KYR 160 F17	160	50	202	61	145	140x110	105x80	13.5x11	240
4102 KYR 200 F17	200	50	247	58	145	140x110	105x80	13.5x11	350



KER		KAMALON KASNAK ÜZERİ VULKANİZE GRİ LASTİK KAPLAMA RULMANLI						
KOD NO								kg
4102 KER 100	100	40	144	46.5	140x110	105x80	13.5x11	140
4102 KER 125	125	40	175	48	140x110	105x80	13.5x11	180
4102 KER 150	150	45	206	52	140x110	105x80	13.5x11	200
4102 KER 160	160	50	202	61	140x110	105x80	13.5x11	240
4102 KER 200	200	50	247	58	140x110	105x80	13.5x11	350





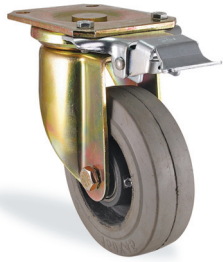





KER		KAMALON KASNAK ÜZERİ VULKANİZE GRİ LASTİK KAPLAMA RULMANLI							
KOD NO									
	mm	mm	mm	mm	mm	mm	mm	mm	kg
4102 KER 100 F18	100	40	144	50.5	163	140x110	105x80	13.5x11	140
4102 KER 125 F18	125	40	175	51	166	140x110	105x80	13.5x11	180
4102 KER 150 F18	150	45	206	56.5	165	140x110	105x80	13.5x11	200
4102 KER 160 F18	160	50	202	58	161	140x110	105x80	13.5x11	240
4102 KER 200 F18	200	50	247	60	162	140x110	105x80	13.5x11	350











YÖN KİLİTLİ

KER		KAMALON KASNAK ÜZERİ VULKANİZE GRİ LASTİK KAPLAMA RULMANLI							
KOD NO									
	mm	mm	mm	mm	mm	mm	mm	mm	kg
4102 KER 100 F17	100	40	144	46.5	145	140x110	105x80	13.5x11	140
4102 KER 125 F17	125	40	175	48	145	140x110	105x80	13.5x11	180
4102 KER 150 F17	150	45	206	52	145	140x110	105x80	13.5x11	200
4102 KER 160 F17	160	50	202	61	145	140x110	105x80	13.5x11	240
4102 KER 200 F17	200	50	247	58	145	140x110	105x80	13.5x11	350



PUB		POLİAMİD KASNAK ÜZERİ POLİÜRETAN KAPLAMA BURÇLU							
KOD NO									
	mm	mm	mm	mm	mm	mm	mm	mm	kg
4102 PUB 055	55	25	87	26	79x70	60x50	8.3x9.6		70
4102 PUB 080	80	30	117	40	105x80	80x60	12x9		140
4102 PUB 100	100	35	144	46.5	140x110	105x80	13.5x11		200
4102 PUB 125	125	40	175	48	140x110	105x80	13.5x11		250
4102 PUB 150	150	45	206	52	140x110	105x80	13.5x11		400
4102 PUB 200	200	50	247	58	140x110	105x80	13.5x11		600







PUB		POLİAMİD KASNAK ÜZERİ POLİÜRETAN KAPLAMA BURÇLU							
KOD NO									
	mm	mm	mm	mm	mm	mm	mm	mm	kg
4102 PUB 055 F18	55	25	87	26	91	79x70	60x50	8.3x9.6	70
4102 PUB 080 F18	80	30	117	40	121	105x80	80x60	12x9	140
4102 PUB 100 F18	100	35	144	46.5	163	140x110	105x80	13.5x11	200
4102 PUB 125 F18	125	40	175	48	166	140x110	105x80	13.5x11	250
4102 PUB 150 F18	150	45	206	52	165	140x110	105x80	13.5x11	400
4102 PUB 200 F18	200	50	247	58	162	140x110	105x80	13.5x11	600

YÖN KİLİTLİ

PUB		POLİAMİD KASNAK ÜZERİ POLİÜRETAN KAPLAMA BURÇLU							
KOD NO									
	mm	mm	mm	mm	mm	mm	mm	mm	kg
4102 PUB 100 F17	100	35	144	46.5	145	140x110	105x80	13.5x11	200
4102 PUB 125 F17	125	40	175	48	145	140x110	105x80	13.5x11	250
4102 PUB 150 F17	150	45	206	52	145	140x110	105x80	13.5x11	400
4102 PUB 200 F17	200	50	247	58	145	140x110	105x80	13.5x11	600



PUR		POLİAMİD KASNAK ÜZERİ POLİÜRETAN KAPLAMA RULMANLI							
KOD NO									
	mm	mm	mm	mm	mm	mm	mm	mm	kg
4102 PUR 055	55	25	87	26	79x70	60x50	8.3x9.6		70
4102 PUR 100	100	35	144	46.5	140x110	105x80	13.5x11		200
4102 PUR 125	125	40	175	48	140x110	105x80	13.5x11		250
4102 PUR 150	150	45	206	52	140x110	105x80	13.5x11		400
4102 PUR 200	200	50	247	58	140x110	105x80	13.5x11		600







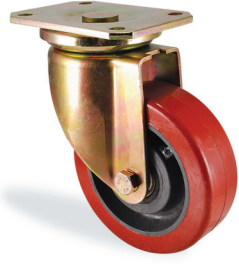

PUR		POLİAMİD KASNAK ÜZERİ POLİÜRETAN KAPLAMA RULMANLI							
KOD NO									
	mm	mm	mm	mm	mm	mm	mm	mm	kg
4102 PUR 055 F18	55	25	87	26	91	79x70	60x50	8.3x9.6	70
4102 PUR 100 F18	100	35	144	50.5	163	140x110	105x80	13.5x11	200
4102 PUR 125 F18	125	40	175	51	166	140x110	105x80	13.5x11	250
4102 PUR 150 F18	150	45	206	56.5	165	140x110	105x80	13.5x11	400
4102 PUR 200 F18	200	50	247	60	162	140x110	105x80	13.5x11	600









YÖN KİLİTLİ

PUR		POLİAMİD KASNAK ÜZERİ POLİÜRETAN KAPLAMA RULMANLI							
KOD NO									
	mm	mm	mm	mm	mm	mm	mm	mm	kg
4102 PUR 100 F17	100	35	144	46.5	145	140x110	105x80	13.5x11	200
4102 PUR 125 F17	125	40	175	48	145	140x110	105x80	13.5x11	250
4102 PUR 150 F17	150	45	206	52	145	140x110	105x80	13.5x11	400
4102 PUR 200 F17	200	50	247	58	145	140x110	105x80	13.5x11	600







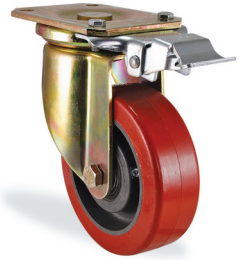

KUR		KAMALON ÜZERİ ENJEKSİYON POLİÜRETAN KAPLAMA RULMANLI						
KOD NO								kg
4102 KUR 100	100	40	144	46.5	140x110	105x80	13.5x11	250
4102 KUR 125	125	50	175	48	140x110	105x80	13.5x11	300
4102 KUR 150	150	50	206	52	140x110	105x80	13.5x11	550
4102 KUR 160	160	50	202	61	140x110	105x80	13.5x11	650
4102 KUR 200	200	50	247	58	140x110	105x80	13.5x11	800









KUR		KAMALON ÜZERİ ENJEKSİYON POLİÜRETAN KAPLAMA RULMANLI							
KOD NO								kg	
4102 KUR 100 F18	100	40	144	50.5	163	140x110	105x80	13.5x11	250
4102 KUR 125 F18	125	50	175	51	166	140x110	105x80	13.5x11	300
4102 KUR 150 F18	150	50	206	56.5	165	140x110	105x80	13.5x11	550
4102 KUR 160 F18	160	50	202	58	161	140x110	105x80	13.5x11	650
4102 KUR 200 F18	200	50	247	60	162	140x110	105x80	13.5x11	800











YÖN KİLİTLİ

KUR		KAMALON ÜZERİ ENJEKSİYON POLİÜRETAN KAPLAMA RULMANLI							
KOD NO								kg	
4102 KUR 100 F17	100	40	144	46.5	145	140x110	105x80	13.5x11	250
4102 KUR 125 F17	125	50	175	48	145	140x110	105x80	13.5x11	300
4102 KUR 150 F17	150	50	206	52	145	140x110	105x80	13.5x11	550
4102 KUR 160 F17	160	50	202	61	145	140x110	105x80	13.5x11	650
4102 KUR 200 F17	200	50	247	58	145	140x110	105x80	13.5x11	800









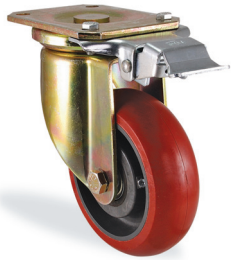

K2UR		KAMALON ÜZERİ OVAL ENJEKSİYON POLİÜRETAN KAPLAMA RULMANLI						
KOD NO								kg
4102 K2UR 100	100	40	144	46.5	140x110	105x80	13.5x11	250
4102 K2UR 125	125	50	175	48	140x110	105x80	13.5x11	300
4102 K2UR 150	150	50	206	52	140x110	105x80	13.5x11	550
4102 K2UR 160	160	50	202	61	140x110	105x80	13.5x11	650
4102 K2UR 200	200	50	247	58	140x110	105x80	13.5x11	800











K2UR		KAMALON ÜZERİ OVAL ENJEKSİYON POLİÜRETAN KAPLAMA RULMANLI							
KOD NO									
	mm	mm	mm	mm	mm	mm	mm	mm	kg
4102 K2UR 100 F18	100	40	144	50.5	163	140x110	105x80	13.5x11	250
4102 K2UR 125 F18	125	45	175	51	166	140x110	105x80	13.5x11	300
4102 K2UR 150 F18	150	50	206	56.5	165	140x110	105x80	13.5x11	550
4102 K2UR 160 F18	160	50	202	58	161	140x110	105x80	13.5x11	650
4102 K2UR 200 F18	200	50	247	60	162	140x110	105x80	13.5x11	800











YÖN KİLİTLİ

K2UR		KAMALON ÜZERİ OVAL ENJEKSİYON POLİÜRETAN KAPLAMA RULMANLI							
KOD NO									
	mm	mm	mm	mm	mm	mm	mm	mm	kg
4102 K2UR 100 F17	100	40	144	46.5	145	140x110	105x80	13.5x11	250
4102 K2UR 125 F17	125	45	175	48	145	140x110	105x80	13.5x11	300
4102 K2UR 150 F17	150	50	206	52	145	140x110	105x80	13.5x11	550
4102 K2UR 160 F17	160	50	202	61	145	140x110	105x80	13.5x11	650
4102 K2UR 200 F17	200	50	247	58	145	140x110	105x80	13.5x11	800



RMB		AĞIR TİP MOBLEN (PP) TEKER BURÇLU							
KOD NO									
	mm	mm	mm	mm	mm	mm	mm	mm	kg
4102 RMB 055	55	25	87	26	79x70	60x50	8.3x9.6		120
4102 RMB 080	80	30	117	40	105x80	80x60	12x9		200
4102 RMB 100	100	35	144	46.5	140x110	105x80	13.5x11		300
4102 RMB 125	125	40	175	48	140x110	105x80	13.5x11		400
4102 RMB 150	150	45	206	52	140x110	105x80	13.5x11		500
4102 RMB 170	170	45	216	52	140x110	105x80	13.5x11		600
4102 RMB 200	200	50	247	58	140x110	105x80	13.5x11		800



RMB		AĞIR TİP MOBLEN (PP) TEKER BURÇLU							
KOD NO									
	mm	mm	mm	mm	mm	mm	mm	mm	kg
4102 RMB 055 F18	55	25	87	26	91	79x70	60x50	8.3x9.6	120
4102 RMB 080 F18	80	30	117	40	121	105x80	80x60	12x9	200
4102 RMB 100 F18	100	35	144	46.5	163	140x110	105x80	13.5x11	300
4102 RMB 125 F18	125	40	175	48	166	140x110	105x80	13.5x11	400
4102 RMB 150 F18	150	45	206	52	165	140x110	105x80	13.5x11	500
4102 RMB 200 F18	200	50	247	58	162	140x110	105x80	13.5x11	800



RMB		AĞIR TİP MOBLEN (PP) TEKER BURÇLU							
KOD NO									
	mm	mm	mm	mm	mm	mm	mm	mm	kg
4102 RMB 170 F09	170	45	216	52	144	140x110	105x80	13.5x11	600

YÖN KİLİTLİ

RMB		AĞIR TİP MOBLEN (PP) TEKER BURÇLU							
KOD NO									
	mm	mm	mm	mm	mm	mm	mm	mm	kg
4102 RMB 100 F17	100	35	144	46.5	145	140x110	105x80	13.5x11	300
4102 RMB 125 F17	125	40	175	48	145	140x110	105x80	13.5x11	400
4102 RMB 150 F17	150	45	206	52	145	140x110	105x80	13.5x11	500
4102 RMB 170 F17	170	45	216	52	145	140x110	105x80	13.5x11	600
4102 RMB 200 F17	200	50	247	58	145	140x110	105x80	13.5x11	800





RPB		AĞIR TİP POLİAMİD TEKER BURÇLU							
KOD NO									
	mm	mm	mm	mm	mm	mm	mm	mm	kg
4102 RPB 055	55	25	87	26	79x70	60x50	8.3x9.6	150	
4102 RPB 080	80	30	117	40	105x80	80x60	12x9	200	
4102 RPB 100	100	35	144	46.5	140x110	105x80	13.5x11	400	
4102 RPB 125	125	40	175	48	140x110	105x80	13.5x11	500	
4102 RPB 150	150	45	206	52	140x110	105x80	13.5x11	600	
4102 RPB 170	170	45	216	52	140x110	105x80	13.5x11	700	
4102 RPB 200	200	50	247	58	140x110	105x80	13.5x11	900	











RPB		AĞIR TİP POLİAMİD TEKER BURÇLU							
KOD NO									
	mm	mm	mm	mm	mm	mm	mm	mm	kg
4102 RPB 055 F18	55	25	87	26	91	79x70	60x50	8.3x9.6	150
4102 RPB 080 F18	80	30	117	40	121	105x80	80x60	12x9	200
4102 RPB 100 F18	100	35	144	46.5	163	140x110	105x80	13.5x11	400
4102 RPB 125 F18	125	40	175	48	166	140x110	105x80	13.5x11	500
4102 RPB 150 F18	150	45	206	52	165	140x110	105x80	13.5x11	600
4102 RPB 200 F18	200	50	247	58	162	140x110	105x80	13.5x11	900











RPB		AĞIR TİP POLİAMİD TEKER BURÇLU							
KOD NO									
	mm	mm	mm	mm	mm	mm	mm	mm	kg
4102 RPB 170 F09	170	45	216	52	144	140x110	105x80	13.5x11	700









YÖN KİLİTLİ

RPB		AĞIR TİP POLİAMİD TEKER BURÇLU							
KOD NO									
	mm	mm	mm	mm	mm	mm	mm	mm	kg
4102 RPB 100 F17	100	35	144	46.5	145	140x110	105x80	13.5x11	400
4102 RPB 125 F17	125	40	175	48	145	140x110	105x80	13.5x11	500
4102 RPB 150 F17	150	45	206	52	145	140x110	105x80	13.5x11	600
4102 RPB 170 F17	170	45	216	52	145	140x110	105x80	13.5x11	700
4102 RPB 200 F17	200	50	247	58	145	140x110	105x80	13.5x11	900





RPR		AĞIR TİP POLİAMİD TEKER RULMANLI							
KOD NO									
	mm	mm	mm	mm	mm	mm	mm	mm	kg
4102 RPR 100	100	35	144	46.5	140x110	105x80	13.5x11	400	
4102 RPR 125	125	40	175	48	140x110	105x80	13.5x11	500	
4102 RPR 150	150	45	206	52	140x110	105x80	13.5x11	600	
4102 RPR 200	200	50	247	58	140x110	105x80	13.5x11	900	





RPR		AĞIR TİP POLİAMİD TEKER RULMANLI							
KOD NO									
	mm	mm	mm	mm	mm	mm	mm	mm	kg
4102 RPR 100 F18	100	35	144	50.5	163	140x110	105x80	13.5x11	400
4102 RPR 125 F18	125	40	175	51	166	140x110	105x80	13.5x11	500
4102 RPR 150 F18	150	45	206	56.5	165	140x110	105x80	13.5x11	600
4102 RPR 200 F18	200	50	247	60	162	140x110	105x80	13.5x11	900

YÖN KİLİTLİ

RPR		AĞIR TİP POLİAMİD TEKER RULMANLI							
KOD NO									
	mm	mm	mm	mm	mm	mm	mm	mm	kg
4102 RPR 100 F17	100	35	144	46.5	145	140x110	105x80	13.5x11	400
4102 RPR 125 F17	125	40	175	48	145	140x110	105x80	13.5x11	500
4102 RPR 150 F17	150	45	206	52	145	140x110	105x80	13.5x11	600
4102 RPR 200 F17	200	50	247	58	145	140x110	105x80	13.5x11	900



KPR		KAMALON KASNAK ÜZERİ POLİAMİD KAPLAMA RULMANLI							
KOD NO									
	mm	mm	mm	mm	mm	mm	mm	mm	kg
4102 KPR 100	100	40	144	46.5	140x110	105x80	13.5x11	350	
4102 KPR 125	125	50	175	48	140x110	105x80	13.5x11	450	
4102 KPR 150	150	50	206	52	140x110	105x80	13.5x11	700	
4102 KPR 160	160	50	202	61	140x110	105x80	13.5x11	800	
4102 KPR 200	200	50	247	58	140x110	105x80	13.5x11	1000	



KPR		KAMALON KASNAK ÜZERİ POLİAMİD KAPLAMA RULMANLI							
KOD NO									
	mm	mm	mm	mm	mm	mm	mm	mm	kg
4102 KPR 100 F18	100	40	144	50.5	163	140x110	105x80	13.5x11	350
4102 KPR 125 F18	125	50	175	51	166	140x110	105x80	13.5x11	450
4102 KPR 150 F18	150	50	206	56.5	165	140x110	105x80	13.5x11	700
4102 KPR 160 F18	160	50	202	61	161	140x110	105x80	13.5x11	800
4102 KPR 200 F18	200	50	247	60	162	140x110	105x80	13.5x11	1000

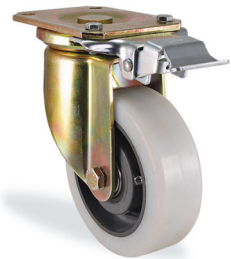







YÖN KİLİTLİ

KPR		KAMALON KASNAK ÜZERİ POLİAMİD KAPLAMA RULMANLI							
KOD NO									
	mm	mm	mm	mm	mm	mm	mm	mm	kg
4102 KPR 100 F17	100	40	144	46.5	145	140x110	105x80	13.5x11	350
4102 KPR 125 F17	125	50	175	48	145	140x110	105x80	13.5x11	450
4102 KPR 150 F17	150	50	206	52	145	140x110	105x80	13.5x11	700
4102 KPR 160 F17	160	50	202	61	145	140x110	105x80	13.5x11	800
4102 KPR 200 F17	200	50	247	58	145	140x110	105x80	13.5x11	1000



K2PR









KAMALON KASNAK ÜZERİ OVAL POLİAMİD KAPLAMA RULMANLI

KOD NO	 mm	 mm	 mm	 mm	 mm	 mm	 mm	 kg
4102 K2PR 100	100	40	144	46.5	140x110	105x80	13.5x11	350
4102 K2PR 125	125	50	175	48	140x110	105x80	13.5x11	450
4102 K2PR 150	150	50	206	52	140x110	105x80	13.5x11	700
4102 K2PR 160	160	50	202	61	140x110	105x80	13.5x11	800
4102 K2PR 200	200	50	247	58	140x110	105x80	13.5x11	1000



K2PR

KAMALON KASNAK ÜZERİ OVAL POLİAMİD KAPLAMA RULMANLI









KOD NO	 mm	 mm	 mm	 mm	 mm	 mm	 mm	 kg	
4102 K2PR 100 F18	100	40	144	50.5	163	140x110	105x80	13.5x11	350
4102 K2PR 125 F18	125	50	175	51	166	140x110	105x80	13.5x11	450
4102 K2PR 150 F18	150	50	206	56.5	165	140x110	105x80	13.5x11	700
4102 K2PR 160 F18	160	50	202	58	161	140x110	105x80	13.5x11	800
4102 K2PR 200 F18	200	50	247	60	162	140x110	105x80	13.5x11	1000



YÖN KİLİTLİ

K2PR

KAMALON KASNAK ÜZERİ OVAL POLİAMİD KAPLAMA RULMANLI

KOD NO	 mm	 mm	 mm	 mm	 mm	 mm	 mm	 kg	
4102 K2PR 100 F17	100	40	144	46.5	145	140x110	105x80	13.5x11	350
4102 K2PR 125 F17	125	50	175	48	145	140x110	105x80	13.5x11	450
4102 K2PR 150 F17	150	50	206	52	145	140x110	105x80	13.5x11	700
4102 K2PR 160 F17	160	50	202	61	145	140x110	105x80	13.5x11	800
4102 K2PR 200 F17	200	50	247	58	145	140x110	105x80	13.5x11	1000

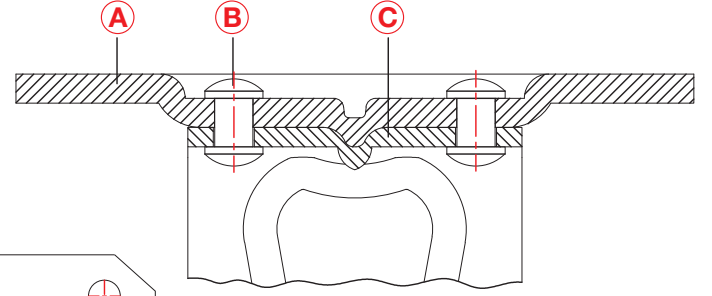

- A:** SABİT TABLA
B: DEMİR PERÇİN
C: SABİT MAŞA

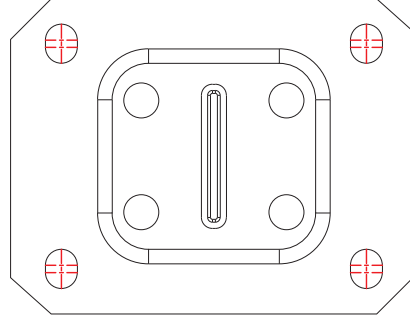







BBC
ISIYA DAYANIKLI BAKALİT TEKER PİRİNÇ BURÇLU (+250°C)

KOD NO	mm	mm	mm	mm	mm	mm	kg
4107 BBC 080	80	30	118	105x80	80x60	12x9	120
4107 BBC 100	100	35	144	140x110	105x80	13.5x11	150
4107 BBC 125	125	40	175	140x110	105x80	13.5x11	300
4107 BBC 150	150	45	206	140x110	105x80	13.5x11	450
4107 BBC 200	200	50	247	140x110	105x80	13.5x11	600









CTB
GÜÇLENDİRİLMİŞ POLİAMİD KASNAK ÜZERİ TERMOELASTİK GRİ LASTİK KAPLAMA BURÇLU

KOD NO	mm	mm	mm	mm	mm	mm	kg
4107 CTB 080	80	30	118	105x80	80x60	12x9	90
4107 CTB 100	100	35	144	140x110	105x80	13.5x11	120
4107 CTB 125	125	40	175	140x110	105x80	13.5x11	150
4107 CTB 150	150	45	206	140x110	105x80	13.5x11	180
4107 CTB 200	200	50	247	140x110	105x80	13.5x11	250









CTR GÜÇLENDİRİLMİŞ POLİAMİD KASNAK ÜZERİ TERMOELASTİK GRİ LASTİK KAPLAMA RULMANLI

KOD NO	 mm	 mm	 mm	 mm	 mm	 mm	 kg
4107 CTR 100	100	35	144	140x110	105x80	13.5x11	120
4107 CTR 125	125	40	175	140x110	105x80	13.5x11	150
4107 CTR 150	150	45	206	140x110	105x80	13.5x11	180
4107 CTR 200	200	50	247	140x110	105x80	13.5x11	250









DDB DÖKÜM TEKER BURÇLU

KOD NO	 mm	 mm	 mm	 mm	 mm	 mm	 kg
4107 DDB 055	55	25	87	79x70	60x50	8.3x9.6	150
4107 DDB 080	80	30	118	105x80	80x60	12x9	200
4107 DDB 100	100	35	144	140x110	105x80	13.5x11	400
4107 DDB 125	125	40	175	140x110	105x80	13.5x11	500
4107 DDB 150	150	45	206	140x110	105x80	13.5x11	800
4107 DDB 170	170	45	216	140x110	105x80	13.5x11	900
4107 DDB 200	200	50	247	140x110	105x80	13.5x11	1100









DDR DÖKÜM TEKER RULMANLI

KOD NO	 mm	 mm	 mm	 mm	 mm	 mm	 kg
4107 DDR 100	100	35	144	140x110	105x80	13.5x11	400
4107 DDR 125	125	40	175	140x110	105x80	13.5x11	500
4107 DDR 150	150	45	206	140x110	105x80	13.5x11	800
4107 DDR 200	200	50	247	140x110	105x80	13.5x11	1100









DOR DÖKÜM ÜZERİ DÖKME POLİÜRETAN KAPLAMA RULMANLI

KOD NO	 mm	 mm	 mm	 mm	 mm	 mm	 kg
4107 DOR 080	80	30	118	105x80	80x60	12x9	200
4107 DOR 100	100	35	144	140x110	105x80	13.5x11	350
4107 DOR 125	125	40	175	140x110	105x80	13.5x11	450
4107 DOR 150	150	45	206	140x110	105x80	13.5x11	700
4107 DOR 200	200	50	247	140x110	105x80	13.5x11	1000









D2OR
DÖKÜM ÜZERİ OVAL DÖKME POLİÜRETAN KAPLAMA RULMANLI

KOD NO	 mm	 mm	 mm	 mm	 mm	 mm	 kg
4107 D2OR 080	80	30	118	105x80	80x60	12x9	200
4107 D2OR 100	100	35	144	140x110	105x80	13.5x11	350
4107 D2OR 125	125	40	175	140x110	105x80	13.5x11	450
4107 D2OR 150	150	45	206	140x110	105x80	13.5x11	700
4107 D2OR 200	200	50	247	140x110	105x80	13.5x11	1000









KOR
KAMALON ÜZERİ DÖKME POLİÜRETAN KAPLAMA RULMANLI

KOD NO	 mm	 mm	 mm	 mm	 mm	 mm	 kg
4107 KOR 100	100	40	144	140x110	105x80	13.5x11	350
4107 KOR 125	125	50	175	140x110	105x80	13.5x11	450
4107 KOR 150	150	50	206	140x110	105x80	13.5x11	700
4107 KOR 160	160	50	205	140x110	105x80	13.5x11	800
4107 KOR 200	200	50	247	140x110	105x80	13.5x11	1000

K2OR
KAMALON ÜZERİ OVAL DÖKME POLİÜRETAN KAPLAMA RULMANLI

KOD NO	 mm	 mm	 mm	 mm	 mm	 mm	 kg
4107 K2OR 100	100	40	144	140x110	105x80	13.5x11	350
4107 K2OR 125	125	50	175	140x110	105x80	13.5x11	450
4107 K2OR 150	150	50	206	140x110	105x80	13.5x11	700
4107 K2OR 160	160	50	205	140x110	105x80	13.5x11	800
4107 K2OR 200	200	50	247	140x110	105x80	13.5x11	1000

DYR
DÖKÜM ÜZERİ VULKANİZE LASTİK KAPLAMA RULMANLI

KOD NO	 mm	 mm	 mm	 mm	 mm	 mm	 kg
4107 DYR 080	80	30	118	105x80	80x60	12x9	90
4107 DYR 100	100	35	144	140x110	105x80	13.5x11	140
4107 DYR 125	125	40	175	140x110	105x80	13.5x11	180
4107 DYR 150	150	45	206	140x110	105x80	13.5x11	200
4107 DYR 170	170	45	216	140x110	105x80	13.5x11	240
4107 DYR 200	200	50	247	140x110	105x80	13.5x11	350









KYR		KAMALON KASNAK ÜZERİ VULKANİZE SİYAH LASTİK KAPLAMA RULMANLI					
KOD NO							
	mm	mm	mm	mm	mm	mm	kg
4107 KYR 100	100	40	144	140x110	105x80	13.5x11	140
4107 KYR 125	125	40	175	140x110	105x80	13.5x11	180
4107 KYR 150	150	45	206	140x110	105x80	13.5x11	200
4107 KYR 160	160	50	205	140x110	105x80	13.5x11	240
4107 KYR 200	200	50	247	140x110	105x80	13.5x11	350









KER		KAMALON KASNAK ÜZERİ VULKANİZE GRİ LASTİK KAPLAMA RULMANLI					
KOD NO							
	mm	mm	mm	mm	mm	mm	kg
4107 KER 100	100	40	144	140x110	105x80	13.5x11	140
4107 KER 125	125	40	175	140x110	105x80	13.5x11	180
4107 KER 150	150	45	206	140x110	105x80	13.5x11	200
4107 KER 160	160	50	205	140x110	105x80	13.5x11	240
4107 KER 200	200	50	247	140x110	105x80	13.5x11	350







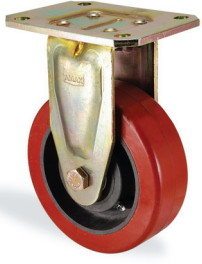

PUB		POLİAMİD KASNAK ÜZERİ POLİÜRETAN KAPLAMA BURÇLU					
KOD NO							
	mm	mm	mm	mm	mm	mm	kg
4107 PUB 055	55	25	87	79x70	60x50	8.3x9.6	70
4107 PUB 080	80	30	118	105x80	80x60	12x9	140
4107 PUB 100	100	35	144	140x110	105x80	13.5x11	200
4107 PUB 125	125	40	175	140x110	105x80	13.5x11	250
4107 PUB 150	150	45	206	140x110	105x80	13.5x11	400
4107 PUB 200	200	50	247	140x110	105x80	13.5x11	600





PUR		POLİAMİD KASNAK ÜZERİ POLİÜRETAN KAPLAMA RULMANLI					
KOD NO							
	mm	mm	mm	mm	mm	mm	kg
4107 PUR 055	55	25	87	79x70	60x50	8.3x9.6	70
4107 PUR 100	100	35	144	140x110	105x80	13.5x11	200
4107 PUR 125	125	40	175	140x110	105x80	13.5x11	250
4107 PUR 150	150	45	206	140x110	105x80	13.5x11	400
4107 PUR 200	200	50	247	140x110	105x80	13.5x11	600









KUR		KAMALON ÜZERİ ENJEKSİYON POLİÜRETAN KAPLAMA RULMANLI					
KOD NO							
	mm	mm	mm	mm	mm	mm	kg
4107 KUR 100	100	40	144	140x110	105x80	13.5x11	250
4107 KUR 125	125	50	175	140x110	105x80	13.5x11	300
4107 KUR 150	150	50	206	140x110	105x80	13.5x11	550
4107 KUR 160	160	50	205	140x110	105x80	13.5x11	650
4107 KUR 200	200	50	247	140x110	105x80	13.5x11	800









K2UR		KAMALON KASNAK ÜZERİ OVAL ENJEKSİYON POLİÜRETAN KAPLAMA RULMANLI					
KOD NO							
	mm	mm	mm	mm	mm	mm	kg
4107 K2UR 100	100	40	144	140x110	105x80	13.5x11	250
4107 K2UR 125	125	50	175	140x110	105x80	13.5x11	300
4107 K2UR 150	150	50	206	140x110	105x80	13.5x11	550
4107 K2UR 160	160	50	205	140x110	105x80	13.5x11	650
4107 K2UR 200	200	50	247	140x110	105x80	13.5x11	800









RMB		AĞIR TİP MOBLEN (PP) TEKER BURÇLU					
KOD NO							
	mm	mm	mm	mm	mm	mm	kg
4107 RMB 055	55	25	87	79x70	60x50	8.3x9.6	120
4107 RMB 080	80	30	118	105x80	80x60	12x9	200
4107 RMB 100	100	35	144	140x110	105x80	13.5x11	300
4107 RMB 125	125	40	175	140x110	105x80	13.5x11	400
4107 RMB 150	150	45	206	140x110	105x80	13.5x11	500
4107 RMB 170	170	45	216	140x110	105x80	13.5x11	600
4107 RMB 200	200	50	247	140x110	105x80	13.5x11	800



RPB		AĞIR TİP POLİAMİD TEKER BURÇLU					
KOD NO							
	mm	mm	mm	mm	mm	mm	kg
4107 RPB 055	55	25	87	79x70	60x50	8.3x9.6	150
4107 RPB 080	80	30	118	105x80	80x60	12x9	200
4107 RPB 100	100	35	144	140x110	105x80	13.5x11	400
4107 RPB 125	125	40	175	140x110	105x80	13.5x11	500
4107 RPB 150	150	45	206	140x110	105x80	13.5x11	600
4107 RPB 170	170	45	216	140x110	105x80	13.5x11	700
4107 RPB 200	200	50	247	140x110	105x80	13.5x11	900









RPR		AĞIR TİP POLİAMİD TEKER RULMANLI					
KOD NO	 mm	 mm	 mm	 mm	 mm	 mm	 kg
4107 RPR 100	100	35	144	140x110	105x80	13.5x11	400
4107 RPR 125	125	40	175	140x110	105x80	13.5x11	500
4107 RPR 150	150	45	206	140x110	105x80	13.5x11	600
4107 RPR 200	200	50	247	140x110	105x80	13.5x11	900



KPR		KAMALON KASNAK ÜZERİ POLİAMİD KAPLAMA RULMANLI					
KOD NO	 mm	 mm	 mm	 mm	 mm	 mm	 kg
4107 KPR 100	100	40	144	140x110	105x80	13.5x11	350
4107 KPR 125	125	50	175	140x110	105x80	13.5x11	450
4107 KPR 150	150	50	206	140x110	105x80	13.5x11	700
4107 KPR 160	160	50	205	140x110	105x80	13.5x11	800
4107 KPR 200	200	50	247	140x110	105x80	13.5x11	1000



K2PR		KAMALON KASNAK ÜZERİ OVAL POLİAMİD KAPLAMA RULMANLI					
KOD NO	 mm	 mm	 mm	 mm	 mm	 mm	 kg
4107 K2PR 100	100	40	144	140x110	105x80	13.5x11	350
4107 K2PR 125	125	50	175	140x110	105x80	13.5x11	450
4107 K2PR 150	150	50	206	140x110	105x80	13.5x11	700
4107 K2PR 160	160	50	205	140x110	105x80	13.5x11	800
4107 K2PR 200	200	50	247	140x110	105x80	13.5x11	1000

- A:** OYNAK TABLA
- B:** TABLA BAĞLANTI CİVATASI
- C:** TABLA ÇANAĞI
- D:** BÜTE RULMAN
- E:** GRESÖRLÜK
- F:** DÖVME ÜST BİLYA ÇANAĞI
- G:** KONİK RULMAN
- H:** MAŞA AYAK KAYNAĞI
- I:** MUHAFAZA TOZLUK METAL KAPAK
- J:** AYARLANABİLİR TAÇLI SOMUN
- K:** YARIKLI PİM
- L:** OYNAK MAŞA AYAĞI

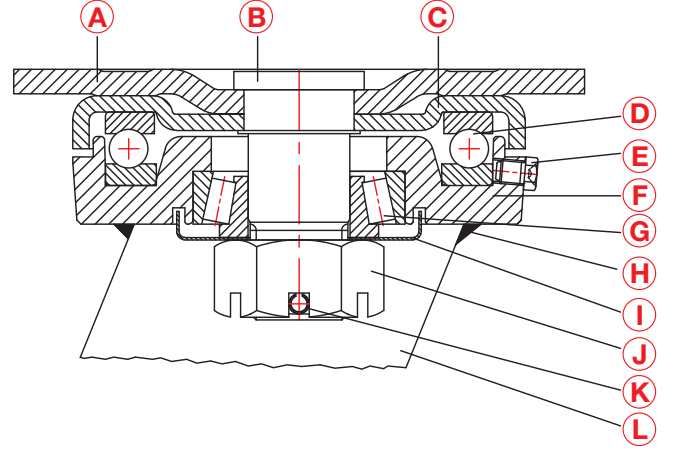
DDR
DÖKÜM TEKER RULMANLI

KOD NO	mm	mm	mm	mm	mm	mm	mm	kg
4302 DDR 150	150	45	220	44	140x110	105x80	13.5x11	800
4302 DDR 200	200	50	265	52	140x110	105x80	13.5x11	1100
4302 DDR 250	250	50	320	64	140x110	105x80	13.5x11	1300

DDR
DÖKÜM TEKER RULMANLI

KOD NO	mm	mm	mm	mm	mm	mm	mm	kg	
4302 DDR 150 F09	150	45	220	44	150	140x110	105x80	13.5x11	800
4302 DDR 200 F09	200	50	265	52	150	140x110	105x80	13.5x11	1100
4302 DDR 250 F09	250	50	320	64	150	140x110	105x80	13.5x11	1300

YÖN KİLİTLİ
DDR
DÖKÜM TEKER RULMANLI

KOD NO	mm	mm	mm	mm	mm	mm	mm	kg	
4302 DDR 150 F17	150	45	220	44	145	140x110	105x80	13.5x11	800
4302 DDR 200 F17	200	50	265	52	145	140x110	105x80	13.5x11	1100
4302 DDR 250 F17	250	50	320	64	145	140x110	105x80	13.5x11	1300





DOR		DÖKÜM KASNAK ÜZERİ DÖKME POLİÜRETAN KAPLAMA RULMANLI						
KOD NO	 mm	 mm	 mm	 mm	 mm	 mm	 mm	 kg
4302 DOR 150	150	45	220	44	140x110	105x80	13.5x11	700
4302 DOR 180	180	50	253	52	140x110	105x80	13.5x11	900
4302 DOR 200	200	50	265	52	140x110	105x80	13.5x11	1000
4302 DOR 250	250	60	320	64	140x110	105x80	13.5x11	1350



DOR		DÖKÜM KASNAK ÜZERİ DÖKME POLİÜRETAN KAPLAMA RULMANLI							
KOD NO	 mm	 mm	 mm	 mm	 mm	 mm	 mm	 kg	
4302 DOR 150 F09	150	45	220	44	150	140x110	105x80	13.5x11	700
4302 DOR 180 F09	180	50	253	52	150	140x110	105x80	13.5x11	900
4302 DOR 200 F09	200	50	265	52	150	140x110	105x80	13.5x11	1000
4302 DOR 250 F09	250	60	320	64	150	140x110	105x80	13.5x11	1350











YÖN KİLİTLİ

DOR		DÖKÜM KASNAK ÜZERİ DÖKME POLİÜRETAN KAPLAMA RULMANLI							
KOD NO	 mm	 mm	 mm	 mm	 mm	 mm	 mm	 kg	
4302 DOR 150 F17	150	45	220	44	145	140x110	105x80	13.5x11	700
4302 DOR 180 F17	180	50	253	52	145	140x110	105x80	13.5x11	900
4302 DOR 200 F17	200	50	265	52	145	140x110	105x80	13.5x11	1000
4302 DOR 250 F17	250	60	320	64	145	140x110	105x80	13.5x11	1350









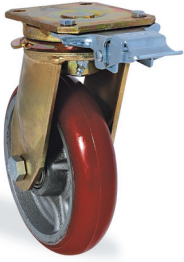

D2OR		DÖKÜM KASNAK ÜZERİ OVAL DÖKME POLİÜRETAN KAPLAMA RULMANLI						
KOD NO	 mm	 mm	 mm	 mm	 mm	 mm	 mm	 kg
4302 D2OR 150	150	45	220	44	140x110	105x80	13.5x11	700
4302 D2OR 180	180	50	253	52	140x110	105x80	13.5x11	900
4302 D2OR 200	200	50	265	52	140x110	105x80	13.5x11	1000
4302 D2OR 250	250	60	320	64	140x110	105x80	13.5x11	1350











D2OR
DÖKÜM KASNAK ÜZERİ OVAL DÖKME POLİÜRETAN KAPLAMA RULMANLI

KOD NO	 mm	 mm	 mm	 mm	 mm	 mm	 mm	 mm	 kg
4302 D2OR 150 F09	150	45	220	44	150	140x110	105x80	13.5x11	700
4302 D2OR 180 F09	180	50	253	52	150	140x110	105x80	13.5x11	900
4302 D2OR 200 F09	200	50	265	52	150	140x110	105x80	13.5x11	1000
4302 D2OR 250 F09	250	60	320	64	150	140x110	105x80	13.5x11	1350











YÖN KİLİTLİ
D2OR
DÖKÜM KASNAK ÜZERİ OVAL DÖKME POLİÜRETAN KAPLAMA RULMANLI

KOD NO	 mm	 mm	 mm	 mm	 mm	 mm	 mm	 mm	 kg
4302 D2OR 150 F17	150	45	220	44	145	140x110	105x80	13.5x11	700
4302 D2OR 180 F17	180	50	253	52	145	140x110	105x80	13.5x11	900
4302 D2OR 200 F17	200	50	265	52	145	140x110	105x80	13.5x11	1000
4302 D2OR 250 F17	250	60	320	64	145	140x110	105x80	13.5x11	1350











KOR
KAMALON KASNAK ÜZERİ DÖKME POLİÜRETAN KAPLAMA RULMANLI

KOD NO	 mm	 mm	 mm	 mm	 mm	 mm	 mm	 mm	 kg
4302 KOR 150	150	50	220	44	140x110	105x80	13.5x11	700	
4302 KOR 160	160	50	225	44	140x110	105x80	13.5x11	800	
4302 KOR 180	180	50	253	52	140x110	105x80	13.5x11	900	
4302 KOR 200	200	50	265	52	140x110	105x80	13.5x11	1000	
4302 KOR 250	250	50	320	64	140x110	105x80	13.5x11	1200	











KOR
KAMALON KASNAK ÜZERİ DÖKME POLİÜRETAN KAPLAMA RULMANLI

KOD NO	 mm	 mm	 mm	 mm	 mm	 mm	 mm	 mm	 kg
4302 KOR 150 F09	150	50	220	44	150	140x110	105x80	13.5x11	700
4302 KOR 160 F09	160	50	225	44	150	140x110	105x80	13.5x11	800
4302 KOR 180 F09	180	50	253	52	150	140x110	105x80	13.5x11	900
4302 KOR 200 F09	200	50	265	52	150	140x110	105x80	13.5x11	1000
4302 KOR 250 F09	250	50	320	64	150	140x110	105x80	13.5x11	1200











YÖN KİLİTLİ
KOR
KAMALON KASNAK ÜZERİ DÖKME POLİÜRETAN KAPLAMA RULMANLI

KOD NO	 mm	 mm	 mm	 mm	 mm	 mm	 mm	 mm	 kg
4302 KOR 150 F17	150	50	220	44	145	140x110	105x80	13.5x11	700
4302 KOR 160 F17	160	50	225	44	145	140x110	105x80	13.5x11	800
4302 KOR 180 F17	180	50	253	52	145	140x110	105x80	13.5x11	900
4302 KOR 200 F17	200	50	265	52	145	140x110	105x80	13.5x11	1000
4302 KOR 250 F17	250	50	320	64	145	140x110	105x80	13.5x11	1200











K2OR
KAMALON KASNAK ÜZERİ OVAL DÖKME POLİÜRETAN KAPLAMA RULMANLI

KOD NO	 mm	 mm	 mm	 mm	 mm	 mm	 mm	 mm	 kg
4302 K2OR 150	150	50	220	44	140x110	105x80	13.5x11	700	
4302 K2OR 160	160	50	225	44	140x110	105x80	13.5x11	800	
4302 K2OR 180	180	50	253	44	140x110	105x80	13.5x11	900	
4302 K2OR 200	200	50	265	52	140x110	105x80	13.5x11	1000	
4302 K2OR 250	250	50	320	64	140x110	105x80	13.5x11	1200	











K2OR
KAMALON KASNAK ÜZERİ OVAL DÖKME POLİÜRETAN KAPLAMA RULMANLI

KOD NO	 mm	 mm	 mm	 mm	 mm	 mm	 mm	 mm	 kg
4302 K2OR 150 F09	150	50	220	44	150	140x110	105x80	13.5x11	700
4302 K2OR 160 F09	160	50	225	44	150	140x110	105x80	13.5x11	800
4302 K2OR 180 F09	180	50	253	44	150	140x110	105x80	13.5x11	900
4302 K2OR 200 F09	200	50	265	52	150	140x110	105x80	13.5x11	1000
4302 K2OR 250 F09	250	50	320	64	150	140x110	105x80	13.5x11	1200











YÖN KİLİTLİ
K2OR
KAMALON KASNAK ÜZERİ OVAL DÖKME POLİÜRETAN KAPLAMA RULMANLI

KOD NO	 mm	 mm	 mm	 mm	 mm	 mm	 mm	 mm	 kg
4302 K2OR 150 F17	150	50	220	44	145	140x110	105x80	13.5x11	700
4302 K2OR 160 F17	160	50	225	44	145	140x110	105x80	13.5x11	800
4302 K2OR 180 F17	180	50	253	44	145	140x110	105x80	13.5x11	900
4302 K2OR 200 F17	200	50	265	52	145	140x110	105x80	13.5x11	1000
4302 K2OR 250 F17	250	50	320	64	145	140x110	105x80	13.5x11	1200











DYZ
DÖKÜM KASNAK ÜZERİ VULKANİZE LASTİK KAPLAMA RULMANLI

KOD NO	 mm	 mm	 mm	 mm	 mm	 mm	 mm	 mm	 kg
4302 DYZ 150	150	45	220	44	140x110	105x80	13.5x11	200	
4302 DYZ 170	170	45	238	47	140x110	105x80	13.5x11	240	
4302 DYZ 200	200	50	265	52	140x110	105x80	13.5x11	350	
4302 DYZ 220	220	50	285	55	140x110	105x80	13.5x11	450	
4302 DYZ 250	250	60	320	64	140x110	105x80	13.5x11	500	







DYZ
DÖKÜM KASNAK ÜZERİ VULKANİZE LASTİK KAPLAMA RULMANLI

KOD NO	 mm	 mm	 mm	 mm	 mm	 mm	 mm	 mm	 kg
4302 DYZ 150 F09	150	45	220	44	150	140x110	105x80	13.5x11	200
4302 DYZ 170 F09	170	45	238	47	150	140x110	105x80	13.5x11	240
4302 DYZ 200 F09	200	50	265	52	150	140x110	105x80	13.5x11	350
4302 DYZ 220 F09	220	50	285	55	150	140x110	105x80	13.5x11	450
4302 DYZ 250 F09	250	60	320	64	150	140x110	105x80	13.5x11	500

YÖN KİLİTLİ
DYZ
DÖKÜM KASNAK ÜZERİ VULKANİZE LASTİK KAPLAMA RULMANLI

KOD NO	 mm	 mm	 mm	 mm	 mm	 mm	 mm	 mm	 kg
4302 DYZ 150 F17	150	45	220	44	145	140x110	105x80	13.5x11	200
4302 DYZ 170 F17	170	45	238	47	145	140x110	105x80	13.5x11	240
4302 DYZ 200 F17	200	50	265	52	145	140x110	105x80	13.5x11	350
4302 DYZ 220 F17	220	50	285	55	145	140x110	105x80	13.5x11	450
4302 DYZ 250 F17	250	60	320	64	145	140x110	105x80	13.5x11	500

KYR
KAMALON KASNAK ÜZERİ VULKANİZE SİYAH LASTİK KAPLAMA RULMANLI

KOD NO	 mm	 mm	 mm	 mm	 mm	 mm	 mm	 mm	 kg
4302 KYR 150	150	45	220	44	140x110	105x80	13.5x11	200	
4302 KYR 160	160	50	225	44	140x110	105x80	13.5x11	240	
4302 KYR 200	200	50	265	52	140x110	105x80	13.5x11	350	
4302 KYR 250	250	50	320	64	140x110	105x80	13.5x11	500	



KYR		KAMALON KASNAK ÜZERİ VULKANİZE SİYAH LASTİK KAPLAMA RULMANLI							
KOD NO									
	mm	mm	mm	mm	mm	mm	mm	mm	kg
4302 KYR 150 F09	150	45	220	44	150	140x110	105x80	13.5x11	200
4302 KYR 160 F09	160	50	225	44	150	140x110	105x80	13.5x11	240
4302 KYR 200 F09	200	50	265	52	150	140x110	105x80	13.5x11	350
4302 KYR 250 F09	250	50	320	64	150	140x110	105x80	13.5x11	500



YÖN KİLİTLİ

KYR		KAMALON KASNAK ÜZERİ VULKANİZE SİYAH LASTİK KAPLAMA RULMANLI							
KOD NO									
	mm	mm	mm	mm	mm	mm	mm	mm	kg
4302 KYR 150 F17	150	45	220	44	145	140x110	105x80	13.5x11	200
4302 KYR 160 F17	160	50	225	44	145	140x110	105x80	13.5x11	240
4302 KYR 200 F17	200	50	265	52	145	140x110	105x80	13.5x11	350
4302 KYR 250 F17	250	50	320	64	145	140x110	105x80	13.5x11	500



KER		KAMALON KASNAK ÜZERİ VULKANİZE GRİ LASTİK KAPLAMA RULMANLI							
KOD NO									
	mm	mm	mm	mm	mm	mm	mm	mm	kg
4302 KER 150	150	45	220	44	150	140x110	105x80	13.5x11	200
4302 KER 160	160	50	225	44	150	140x110	105x80	13.5x11	240
4302 KER 200	200	50	265	52	150	140x110	105x80	13.5x11	350
4302 KER 250	250	50	320	64	150	140x110	105x80	13.5x11	500





KER		KAMALON KASNAK ÜZERİ VULKANİZE GRİ LASTİK KAPLAMA RULMANLI							
KOD NO									
	mm	mm	mm	mm	mm	mm	mm	mm	kg
4302 KER 150 F09	150	45	220	44	150	140x110	105x80	13.5x11	200
4302 KER 160 F09	160	50	225	44	150	140x110	105x80	13.5x11	240
4302 KER 200 F09	200	50	265	52	150	140x110	105x80	13.5x11	350
4302 KER 250 F09	250	50	320	64	150	140x110	105x80	13.5x11	500











YÖN KİLİTLİ

KER		KAMALON KASNAK ÜZERİ VULKANİZE GRİ LASTİK KAPLAMA RULMANLI							
KOD NO									
	mm	mm	mm	mm	mm	mm	mm	mm	kg
4302 KER 150 F17	150	45	220	44	145	140x110	105x80	13.5x11	200
4302 KER 160 F17	160	50	225	44	145	140x110	105x80	13.5x11	240
4302 KER 200 F17	200	50	265	52	145	140x110	105x80	13.5x11	350
4302 KER 250 F17	250	50	320	64	145	140x110	105x80	13.5x11	500











PUR		POLİAMİD KASNAK ÜZERİ POLİÜRETAN KAPLAMA RULMANLI							
KOD NO									
	mm	mm	mm	mm	mm	mm	mm	mm	kg
4302 PUR 150	150	45	220	44	140x110	105x80	13.5x11	13.5x11	400
4302 PUR 200	200	50	265	52	140x110	105x80	13.5x11	13.5x11	600







PUR		POLİAMİD KASNAK ÜZERİ POLİÜRETAN KAPLAMA RULMANLI							
KOD NO									
	mm	mm	mm	mm	mm	mm	mm	mm	kg
4302 PUR 150 F09	150	45	220	44	150	140x110	105x80	13.5x11	400
4302 PUR 200 F09	200	50	265	52	150	140x110	105x80	13.5x11	600

YÖN KİLİTLİ

PUR		POLİAMİD KASNAK ÜZERİ POLİÜRETAN KAPLAMA RULMANLI							
KOD NO									
	mm	mm	mm	mm	mm	mm	mm	mm	kg
4302 PUR 150 F17	150	45	220	44	145	140x110	105x80	13.5x11	400
4302 PUR 200 F17	200	50	265	52	145	140x110	105x80	13.5x11	600



KUR		KAMALON KASNAK ÜZERİ ENJEKSİYON POLİÜRETAN KAPLAMA RULMANLI						
KOD NO								
	mm	mm	mm	mm	mm	mm	mm	kg
4302 KUR 150	150	50	220	44	140x110	105x80	13.5x11	550
4302 KUR 160	160	50	225	44	140x110	105x80	13.5x11	650
4302 KUR 200	200	50	265	52	140x110	105x80	13.5x11	800











KUR		KAMALON KASNAK ÜZERİ ENJEKSİYON POLİÜRETAN KAPLAMA RULMANLI							
KOD NO									
	mm	mm	mm	mm	mm	mm	mm	mm	kg
4302 KUR 150 F09	150	50	220	44	150	140x110	105x80	13.5x11	550
4302 KUR 160 F09	160	50	225	44	150	140x110	105x80	13.5x11	650
4302 KUR 200 F09	200	50	265	52	150	140x110	105x80	13.5x11	800











YÖN KİLİTLİ

KUR		KAMALON KASNAK ÜZERİ ENJEKSİYON POLİÜRETAN KAPLAMA RULMANLI							
KOD NO									
	mm	mm	mm	mm	mm	mm	mm	mm	kg
4302 KUR 150 F17	150	50	220	44	145	140x110	105x80	13.5x11	550
4302 KUR 160 F17	160	50	225	44	145	140x110	105x80	13.5x11	650
4302 KUR 200 F17	200	50	265	52	145	140x110	105x80	13.5x11	800











K2UR		KAMALON KASNAK ÜZERİ OVAL ENJEKSİYON POLİÜRETAN KAPLAMA RULMANLI						
KOD NO								
	mm	mm	mm	mm	mm	mm	mm	kg
4302 K2UR 150	150	50	220	44	140x110	105x80	13.5x11	550
4302 K2UR 160	160	50	225	44	140x110	105x80	13.5x11	650
4302 K2UR 180	180	50	253	44	140x110	105x80	13.5x11	700
4302 K2UR 200	200	50	265	52	140x110	105x80	13.5x11	800











K2UR
KAMALON KASNAK ÜZERİ OVAL ENJEKSİYON POLİÜRETAN KAPLAMA RULMANLI

KOD NO	 mm	 mm	 mm	 mm	 mm	 mm	 mm	 mm	 kg
4302 K2UR 150 F09	150	50	220	44	150	140x110	105x80	13.5x11	550
4302 K2UR 160 F09	160	50	225	44	150	140x110	105x80	13.5x11	650
4302 K2UR 180 F09	180	50	253	44	150	140x110	105x80	13.5x11	700
4302 K2UR 200 F09	200	50	265	52	150	140x110	105x80	13.5x11	800











YÖN KİLİTLİ
K2UR
KAMALON KASNAK ÜZERİ OVAL ENJEKSİYON POLİÜRETAN KAPLAMA RULMANLI

KOD NO	 mm	 mm	 mm	 mm	 mm	 mm	 mm	 mm	 kg
4302 K2UR 150 F17	150	50	220	44	145	140x110	105x80	13.5x11	550
4302 K2UR 160 F17	160	50	225	44	145	140x110	105x80	13.5x11	650
4302 K2UR 180 F17	180	50	253	44	145	140x110	105x80	13.5x11	700
4302 K2UR 200 F17	200	50	265	52	145	140x110	105x80	13.5x11	800











RPR
AĞIR TİP POLİAMİD TEKER RULMANLI

KOD NO	 mm	 mm	 mm	 mm	 mm	 mm	 mm	 mm	 kg
4302 RPR 150	150	45	220	44	140x110	105x80	13.5x11		600
4302 RPR 200	200	50	265	52	140x110	105x80	13.5x11		900
4302 RPR 250	250	60	320	64	140x110	105x80	13.5x11		1100



RPR
AĞIR TİP POLİAMİD TEKER RULMANLI

KOD NO	 mm	 mm	 mm	 mm	 mm	 mm	 mm	 mm	 kg
4302 RPR 150 F09	150	45	220	44	150	140x110	105x80	13.5x11	600
4302 RPR 200 F09	200	50	265	52	150	140x110	105x80	13.5x11	900
4302 RPR 250 F09	250	60	320	64	150	140x110	105x80	13.5x11	1100

YÖN KİLİTLİ

RPR		AĞIR TİP POLİAMİD TEKER RULMANLI							
KOD NO									
	mm	mm	mm	mm	mm	mm	mm	mm	kg
4302 RPR 150 F17	150	45	220	44	145	140x110	105x80	13.5x11	600
4302 RPR 200 F17	200	50	265	52	145	140x110	105x80	13.5x11	900
4302 RPR 250 F17	250	60	320	64	145	140x110	105x80	13.5x11	1100



KPR		KAMALON KASNAK ÜZERİ POLİAMİD KAPLAMA RULMANLI							
KOD NO									
	mm	mm	mm	mm	mm	mm	mm	mm	kg
4302 KPR 150	150	50	220	44	140x110	105x80	13.5x11	700	
4302 KPR 160	160	50	225	44	140x110	105x80	13.5x11	800	
4302 KPR 200	200	50	265	52	140x110	105x80	13.5x11	1000	











KPR		KAMALON KASNAK ÜZERİ POLİAMİD KAPLAMA RULMANLI							
KOD NO									
	mm	mm	mm	mm	mm	mm	mm	mm	kg
4302 KPR 150 F09	150	50	220	44	150	140x110	105x80	13.5x11	700
4302 KPR 160 F09	160	50	225	44	150	140x110	105x80	13.5x11	800
4302 KPR 200 F09	200	50	265	52	150	140x110	105x80	13.5x11	1000

YÖN KİLİTLİ

KPR		KAMALON KASNAK ÜZERİ POLİAMİD KAPLAMA RULMANLI							
KOD NO									
	mm	mm	mm	mm	mm	mm	mm	mm	kg
4302 KPR 150 F17	150	50	220	44	145	140x110	105x80	13.5x11	700
4302 KPR 160 F17	160	50	225	44	145	140x110	105x80	13.5x11	800
4302 KPR 200 F17	200	50	265	52	145	140x110	105x80	13.5x11	1000



K2PR		KAMALON KASNAK ÜZERİ OVAL POLİAMİD KAPLAMA RULMANLI						
KOD NO								
	mm	mm	mm	mm	mm	mm	mm	kg
4302 K2PR 150	150	50	220	44	140x110	105x80	13.5x11	700
4302 K2PR 160	160	50	225	44	140x110	105x80	13.5x11	800
4302 K2PR 180	180	50	253	44	140x110	105x80	13.5x11	900
4302 K2PR 200	200	50	265	52	140x110	105x80	13.5x11	1000



K2PR		KAMALON KASNAK ÜZERİ OVAL POLİAMİD KAPLAMA RULMANLI							
KOD NO									
	mm	mm	mm	mm	mm	mm	mm	mm	kg
4302 K2PR 150 F09	150	50	220	44	150	140x110	105x80	13.5x11	700
4302 K2PR 160 F09	160	50	225	44	150	140x110	105x80	13.5x11	800
4302 K2PR 180 F09	180	50	253	44	150	140x110	105x80	13.5x11	900
4302 K2PR 200 F09	200	50	265	52	150	140x110	105x80	13.5x11	1000







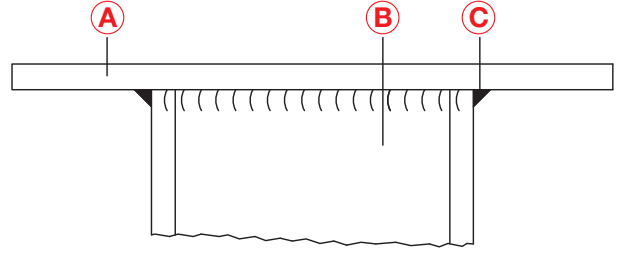

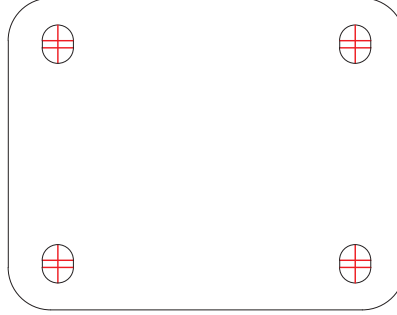

K2PR		KAMALON KASNAK ÜZERİ OVAL POLİAMİD KAPLAMA RULMANLI							
KOD NO									
	mm	mm	mm	mm	mm	mm	mm	mm	kg
4302 K2PR 150 F17	150	50	220	44	145	140x110	105x80	13.5x11	700
4302 K2PR 160 F17	160	50	225	44	145	140x110	105x80	13.5x11	800
4302 K2PR 180 F17	180	50	253	44	145	140x110	105x80	13.5x11	900
4302 K2PR 200 F17	200	50	265	52	145	140x110	105x80	13.5x11	1000

YÖN KİLİTLİ









- A: SABİT TABLA
B: SABİT MAŞA AYAĞI
C: MAŞA AYAĞI KAYNAĞI









DDR		DÖKÜM TEKER RULMANLI					
KOD NO							
	mm	mm	mm	mm	mm	mm	kg
4307 DDR 150	150	45	220	140x110	105x80	13.5x11	800
4307 DDR 200	200	50	265	140x110	105x80	13.5x11	1100
4307 DDR 250	250	50	320	140x110	105x80	13.5x11	1300



DOR		DÖKÜM KASNAK ÜZERİ DÖKME POLİÜRETAN KAPLAMA RULMANLI					
KOD NO							
	mm	mm	mm	mm	mm	mm	kg
4307 DOR 150	150	45	220	140x110	105x80	13.5x11	700
4307 DOR 180	180	50	253	140x110	105x80	13.5x11	900
4307 DOR 200	200	50	265	140x110	105x80	13.5x11	1000
4307 DOR 250	250	60	320	140x110	105x80	13.5x11	1350









D2OR		DÖKÜM KASNAK ÜZERİ OVAL DÖKME POLİÜRETAN KAPLAMA RULMANLI					
KOD NO							
	mm	mm	mm	mm	mm	mm	kg
4307 D2OR 150	150	45	220	140x110	105x80	13.5x11	700
4307 D2OR 180	180	50	253	140x110	105x80	13.5x11	900
4307 D2OR 200	200	50	265	140x110	105x80	13.5x11	1000
4307 D2OR 250	250	60	320	140x110	105x80	13.5x11	1350









KOR		KAMALON KASNAK ÜZERİ DÖKME POLİÜRETAN KAPLAMA RULMANLI					
KOD NO							
	mm	mm	mm	mm	mm	mm	kg
4307 KOR 150	150	50	220	140x110	105x80	13.5x11	700
4307 KOR 160	160	50	225	140x110	105x80	13.5x11	800
4307 KOR 180	180	50	253	140x110	105x80	13.5x11	900
4307 KOR 200	200	50	265	140x110	105x80	13.5x11	1000
4307 KOR 250	250	50	320	140x110	105x80	13.5x11	1200









K2OR
KAMALON KASNAK ÜZERİ OVAL DÖKME POLİÜRETAN KAPLAMA RULMANLI

KOD NO	 mm	 mm	 mm	 mm	 mm	 mm	 kg
4307 K2OR 150	150	50	220	140x110	105x80	13.5x11	700
4307 K2OR 160	160	50	225	140x110	105x80	13.5x11	800
4307 K2OR 180	180	50	253	140x110	105x80	13.5x11	900
4307 K2OR 200	200	50	265	140x110	105x80	13.5x11	1000
4307 K2OR 250	250	50	320	140x110	105x80	13.5x11	1200









DYR
DÖKÜM KASNAK ÜZERİ VULKANİZE LASTİK KAPLAMA RULMANLI

KOD NO	 mm	 mm	 mm	 mm	 mm	 mm	 kg
4307 DYR 150	150	45	220	140x110	105x80	13.5x11	200
4307 DYR 170	170	45	238	140x110	105x80	13.5x11	240
4307 DYR 200	200	50	265	140x110	105x80	13.5x11	350
4307 DYR 220	220	50	285	140x110	105x80	13.5x11	450
4307 DYR 250	250	60	320	140x110	105x80	13.5x11	500









KYR
KAMALON KASNAK ÜZERİ VULKANİZE SİYAH LASTİK KAPLAMA RULMANLI

KOD NO	 mm	 mm	 mm	 mm	 mm	 mm	 kg
4307 KYR 150	150	45	220	140x110	105x80	13.5x11	200
4307 KYR 160	160	50	225	140x110	105x80	13.5x11	240
4307 KYR 200	200	50	265	140x110	105x80	13.5x11	350
4307 KYR 250	250	50	320	140x110	105x80	13.5x11	500









KER
KAMALON KASNAK ÜZERİ VULKANİZE GRİ LASTİK KAPLAMA RULMANLI

KOD NO	 mm	 mm	 mm	 mm	 mm	 mm	 kg
4307 KER 150	150	45	220	140x110	105x80	13.5x11	200
4307 KER 160	160	50	225	140x110	105x80	13.5x11	240
4307 KER 200	200	50	265	140x110	105x80	13.5x11	350
4307 KER 250	250	50	320	140x110	105x80	13.5x11	500

PUR
POLİAMİD KASNAK ÜZERİ POLİÜRETAN KAPLAMA RULMANLI

KOD NO	 mm	 mm	 mm	 mm	 mm	 mm	 kg
4307 PUR 150	150	45	220	140x110	105x80	13.5x11	400
4307 PUR 200	200	50	265	140x110	105x80	13.5x11	600









KUR		KAMALON KASNAK ÜZERİ ENJEKSİYON POLİÜRETAN KAPLAMA RULMANLI					
KOD NO	 mm	 mm	 mm	 mm	 mm	 mm	 kg
4307 KUR 150	150	50	220	140x110	105x80	13.5x11	550
4307 KUR 160	160	50	225	140x110	105x80	13.5x11	650
4307 KUR 200	200	50	265	140x110	105x80	13.5x11	800



K2UR		KAMALON KASNAK ÜZERİ OVAL ENJEKSİYON POLİÜRETAN KAPLAMA RULMANLI					
KOD NO	 mm	 mm	 mm	 mm	 mm	 mm	 kg
4307 K2UR 150	150	50	220	140x110	105x80	13.5x11	550
4307 K2UR 160	160	50	225	140x110	105x80	13.5x11	650
4307 K2UR 180	180	50	253	140x110	105x80	13.5x11	750
4307 K2UR 200	200	50	265	140x110	105x80	13.5x11	800









RPR		AĞIR TİP POLİAMİD TEKER RULMANLI					
KOD NO	 mm	 mm	 mm	 mm	 mm	 mm	 kg
4307 RPR 150	150	45	220	140x110	105x80	13.5x11	600
4307 RPR 200	200	50	265	140x110	105x80	13.5x11	900
4307 RPR 250	250	60	320	140x110	105x80	13.5x11	1100



KPR		KAMALON KASNAK ÜZERİ POLİAMİD KAPLAMA RULMANLI					
KOD NO	 mm	 mm	 mm	 mm	 mm	 mm	 kg
4307 KPR 150	150	50	220	140x110	105x80	13.5x11	700
4307 KPR 160	160	50	225	140x110	105x80	13.5x11	800
4307 KPR 200	200	50	265	140x110	105x80	13.5x11	1000



K2PR		KAMALON KASNAK ÜZERİ OVAL POLİAMİD KAPLAMA RULMANLI					
KOD NO	 mm	 mm	 mm	 mm	 mm	 mm	 kg
4307 K2PR 150	150	50	220	140x110	105x80	13.5x11	700
4307 K2PR 160	160	50	225	140x110	105x80	13.5x11	800
4307 K2PR 180	180	50	253	140x110	105x80	13.5x11	900
4307 K2PR 200	200	50	265	140x110	105x80	13.5x11	1000

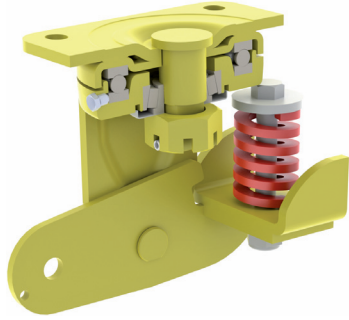



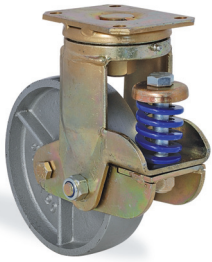
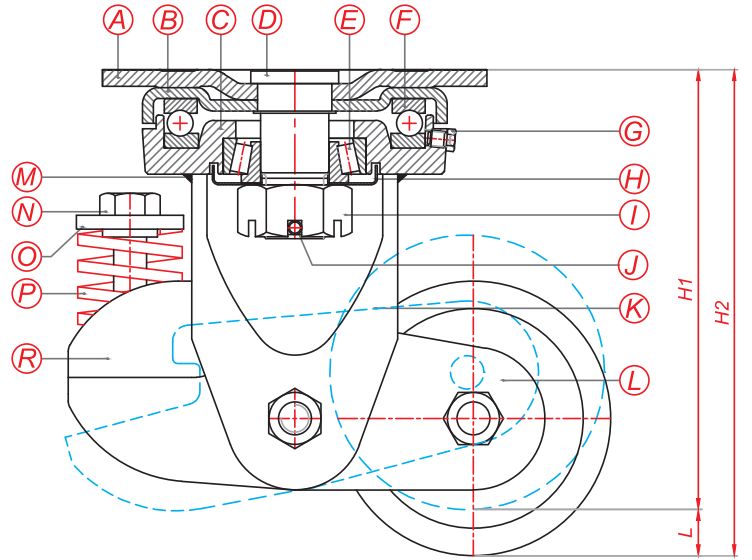



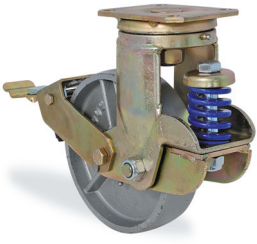

- A:** OYNAK TABLA
- B:** ÜST BİLYA KAPAĞI
- C:** DÖVME ÜST BİLYA ÇANAĞI
- D:** TABLA CİVATASI
- E:** KONİK RULMAN
- F:** BÜTE RULMAN
- G:** GRESÖRLÜK
- H:** METAL MAHUFZA TOZLUK
- I:** AYARLANABİLİR TAÇLI SOMUN
- J:** YARIKLI PİM
- K:** MAŞA AYAĞI
- L:** HAREKETLİ MAŞA AYAĞI
- M:** MAŞA AYAK KAYNAĞI
- N:** YAY MONTAJ CİVATASI
- O:** YAY BASKI SACI
- P:** AMORTİSÖR YAYI
- R:** YAY KAPATMA SACI



DDR		DÖKÜM TEKER RULMANLI										
KOD NO							MAKSİMUM TAŞIMA KAPASİTESİ kg	ÖN GERME KUVVETİ kg	H2 TOPLAM YÜKSEKLİK mm	H1 YÜKLÜ TOPLAM YÜKSEKLİK mm	L YAY YOLU mm	YAYIN SON KUVVETİ kg
AD4302 DDR 100 Y	100	35	65	140x110	105x80	13.5x11	400	40	177	160	17	160
AD4302 DDR 100 M	100	35	65	140x110	105x80	13.5x11	400	70	177	160	17	300
AD4302 DDR 100 K	100	35	65	140x110	105x80	13.5x11	400	80	177	160	17	450
AD4302 DDR 125 Y	125	40	65	140x110	105x80	13.5x11	500	40	189.5	172.5	17	160
AD4302 DDR 125 M	125	40	65	140x110	105x80	13.5x11	500	70	189.5	172.5	17	300
AD4302 DDR 125 K	125	40	65	140x110	105x80	13.5x11	500	80	189.5	172.5	17	450
AD4302 DDR 150 Y	150	45	65	140x110	105x80	13.5x11	800	50	220	201	18	160
AD4302 DDR 150 M	150	45	65	140x110	105x80	13.5x11	800	80	220	201	18	300
AD4302 DDR 150 K	150	45	65	140x110	105x80	13.5x11	800	100	220	201	18	450
AD4302 DDR 150 S	150	45	65	140x110	105x80	13.5x11	800	120	220	201	18	700
AD4302 DDR 200 Y	200	50	70	140x110	105x80	13.5x11	1100	70	275	253	22	190
AD4302 DDR 200 M	200	50	70	140x110	105x80	13.5x11	1100	90	275	253	22	300
AD4302 DDR 200 K	200	50	70	140x110	105x80	13.5x11	1100	110	275	253	22	450
AD4302 DDR 200 S	200	50	70	140x110	105x80	13.5x11	1100	130	275	253	22	700





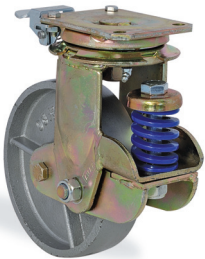

AD4302 Serisi (Amortisörlü)



DDR		DÖKÜM TEKER RULMANLI											
KOD NO								MAKSİMUM TAŞIMA KAPASİTESİ kg	ÖN GERME KUVVETİ kg	H2 TOPLAM YÜKSEKLİK mm	H1 YÜKLÜ TOPLAM YÜKSEKLİK mm	L YAY YOLU mm	YAYIN SON KUVVETİ kg
AD4302 DDR 100 F04 Y	100	35	65	247	140x110	105x80	13.5x11	400	40	177	160	17	160
AD4302 DDR 100 F04 M	100	35	65	247	140x110	105x80	13.5x11	400	70	177	160	17	300
AD4302 DDR 100 F04 K	100	35	65	247	140x110	105x80	13.5x11	400	80	177	160	17	450
AD4302 DDR 125 F04 Y	125	40	65	257	140x110	105x80	13.5x11	500	40	189.5	172.5	17	160
AD4302 DDR 125 F04 M	125	40	65	257	140x110	105x80	13.5x11	500	70	189.5	172.5	17	300
AD4302 DDR 125 F04 K	125	40	65	257	140x110	105x80	13.5x11	500	80	189.5	172.5	17	450
AD4302 DDR 150 F04 Y	150	45	65	262	140x110	105x80	13.5x11	800	50	220	201	18	160
AD4302 DDR 150 F04 M	150	45	65	262	140x110	105x80	13.5x11	800	80	220	201	18	300
AD4302 DDR 150 F04 K	150	45	65	262	140x110	105x80	13.5x11	800	100	220	201	18	450
AD4302 DDR 150 F04 S	150	45	65	262	140x110	105x80	13.5x11	800	120	220	201	18	700
AD4302 DDR 200 F04 Y	200	50	70	290	140x110	105x80	13.5x11	1100	70	275	253	22	190
AD4302 DDR 200 F04 M	200	50	70	290	140x110	105x80	13.5x11	1100	90	275	253	22	300
AD4302 DDR 200 F04 K	200	50	70	290	140x110	105x80	13.5x11	1100	110	275	253	22	450
AD4302 DDR 200 F04 S	200	50	70	290	140x110	105x80	13.5x11	1100	130	275	253	22	700







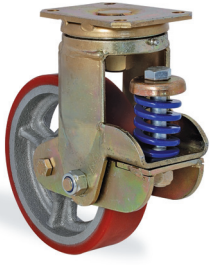

YÖN KİLİTLİ

DDR		DÖKÜM TEKER RULMANLI											
KOD NO								MAKSİMUM TAŞIMA KAPASİTESİ kg	ÖN GERME KUVVETİ kg	H2 TOPLAM YÜKSEKLİK mm	H1 YÜKLÜ TOPLAM YÜKSEKLİK mm	L YAY YOLU mm	YAYIN SON KUVVETİ kg
AD4302 DDR 100 F17 Y	100	35	65	145	140x110	105x80	13.5x11	400	40	177	160	17	160
AD4302 DDR 100 F17 M	100	35	65	145	140x110	105x80	13.5x11	400	70	177	160	17	300
AD4302 DDR 100 F17 K	100	35	65	145	140x110	105x80	13.5x11	400	80	177	160	17	450
AD4302 DDR 125 F17 Y	125	40	65	145	140x110	105x80	13.5x11	500	40	189.5	172.5	17	160
AD4302 DDR 125 F17 M	125	40	65	145	140x110	105x80	13.5x11	500	70	189.5	172.5	17	300
AD4302 DDR 125 F17 K	125	40	65	145	140x110	105x80	13.5x11	500	80	189.5	172.5	17	450
AD4302 DDR 150 F17 Y	150	45	65	145	140x110	105x80	13.5x11	800	50	220	201	18	160
AD4302 DDR 150 F17 M	150	45	65	145	140x110	105x80	13.5x11	800	80	220	201	18	300
AD4302 DDR 150 F17 K	150	45	65	145	140x110	105x80	13.5x11	800	100	220	201	18	450
AD4302 DDR 150 F17 S	150	45	65	145	140x110	105x80	13.5x11	800	120	220	201	18	700
AD4302 DDR 200 F17 Y	200	50	70	145	140x110	105x80	13.5x11	1100	70	275	253	22	190
AD4302 DDR 200 F17 M	200	50	70	145	140x110	105x80	13.5x11	1100	90	275	253	22	300
AD4302 DDR 200 F17 K	200	50	70	145	140x110	105x80	13.5x11	1100	110	275	253	22	450
AD4302 DDR 200 F17 S	200	50	70	145	140x110	105x80	13.5x11	1100	130	275	253	22	700



DOR





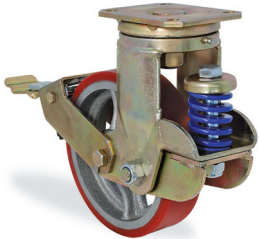

DÖKÜM KASNAK ÜZERİ DÖKME POLİÜRETAN KAPLAMA RULMANLI

KOD NO	 mm	 mm	 mm	 mm	 mm	 mm	MAKSİMUM TAŞIMA KAPASİTESİ kg	ÖN GERME KUVVETİ kg	H2 TOPLAM YÜKSEKLİK mm	H1 YÜKLÜ TOPLAM YÜKSEKLİK mm	L YAY YOLU mm	YAYIN SON KUVVETİ kg
AD4302 DOR 100 Y	100	35	65	140x110	105x80	13.5x11	350	40	177	160	17	160
AD4302 DOR 100 M	100	35	65	140x110	105x80	13.5x11	350	70	177	160	17	300
AD4302 DOR 100 K	100	35	65	140x110	105x80	13.5x11	350	80	177	160	17	450
AD4302 DOR 125 Y	125	40	65	140x110	105x80	13.5x11	450	40	189.5	172.5	17	160
AD4302 DOR 125 M	125	40	65	140x110	105x80	13.5x11	450	70	189.5	172.5	17	300
AD4302 DOR 125 K	125	40	65	140x110	105x80	13.5x11	450	80	189.5	172.5	17	450
AD4302 DOR 150 Y	150	45	65	140x110	105x80	13.5x11	700	50	220	201	18	160
AD4302 DOR 150 M	150	45	65	140x110	105x80	13.5x11	700	80	220	201	18	300
AD4302 DOR 150 K	150	45	65	140x110	105x80	13.5x11	700	100	220	201	18	450
AD4302 DOR 150 S	150	45	65	140x110	105x80	13.5x11	700	120	220	201	18	700
AD4302 DOR 200 Y	200	50	70	140x110	105x80	13.5x11	1000	70	275	253	22	190
AD4302 DOR 200 M	200	50	70	140x110	105x80	13.5x11	1000	90	275	253	22	300
AD4302 DOR 200 K	200	50	70	140x110	105x80	13.5x11	1000	110	275	253	22	450
AD4302 DOR 200 S	200	50	70	140x110	105x80	13.5x11	1000	130	275	253	22	700



DOR

DÖKÜM KASNAK ÜZERİ DÖKME POLİÜRETAN KAPLAMA RULMANLI

KOD NO	 mm	 mm	 mm	 mm	 mm	 mm	MAKSİMUM TAŞIMA KAPASİTESİ kg	ÖN GERME KUVVETİ kg	H2 TOPLAM YÜKSEKLİK mm	H1 YÜKLÜ TOPLAM YÜKSEKLİK mm	L YAY YOLU mm	YAYIN SON KUVVETİ kg	
AD4302 DOR 100 F04 Y	100	35	65	247	140x110	105x80	13.5x11	350	40	177	160	17	160
AD4302 DOR 100 F04 M	100	35	65	247	140x110	105x80	13.5x11	350	70	177	160	17	300
AD4302 DOR 100 F04 K	100	35	65	247	140x110	105x80	13.5x11	350	80	177	160	17	450
AD4302 DOR 125 F04 Y	125	40	65	257	140x110	105x80	13.5x11	450	40	189.5	172.5	17	160
AD4302 DOR 125 F04 M	125	40	65	257	140x110	105x80	13.5x11	450	70	189.5	172.5	17	300
AD4302 DOR 125 F04 K	125	40	65	257	140x110	105x80	13.5x11	450	80	189.5	172.5	17	450
AD4302 DOR 150 F04 Y	150	45	65	262	140x110	105x80	13.5x11	700	50	220	201	18	160
AD4302 DOR 150 F04 M	150	45	65	262	140x110	105x80	13.5x11	700	80	220	201	18	300
AD4302 DOR 150 F04 K	150	45	65	262	140x110	105x80	13.5x11	700	100	220	201	18	450
AD4302 DOR 150 F04 S	150	45	65	262	140x110	105x80	13.5x11	700	120	220	201	18	700
AD4302 DOR 200 F04 Y	200	50	70	290	140x110	105x80	13.5x11	1000	70	275	253	22	190
AD4302 DOR 200 F04 M	200	50	70	290	140x110	105x80	13.5x11	1000	90	275	253	22	300
AD4302 DOR 200 F04 K	200	50	70	290	140x110	105x80	13.5x11	1000	110	275	253	22	450
AD4302 DOR 200 F04 S	200	50	70	290	140x110	105x80	13.5x11	1000	130	275	253	22	700



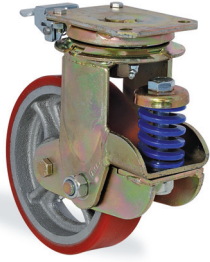



AD4302 Serisi (Amortisörlü)



YÖN KİLİTLİ

DOR





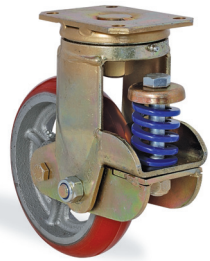

DÖKÜM KASNAK ÜZERİ DÖKME POLİÜRETAN KAPLAMA RULMANLI

KOD NO								MAKSİMUM TAŞIMA KAPASİTESİ kg	ÖN GERME KUVVETİ kg	H2 TOPLAM YÜKSEKLİK mm	H1 YÜKLÜ TOPLAM YÜKSEKLİK mm	L YAY YOLU mm	YAYIN SON KUVVETİ kg
AD4302 DOR 100 F17 Y	100	35	65	145	140x110	105x80	13.5x11	350	40	177	160	17	160
AD4302 DOR 100 F17 M	100	35	65	145	140x110	105x80	13.5x11	350	70	177	160	17	300
AD4302 DOR 100 F17 K	100	35	65	145	140x110	105x80	13.5x11	350	80	177	160	17	450
AD4302 DOR 125 F17 Y	125	40	65	145	140x110	105x80	13.5x11	450	40	189.5	172.5	17	160
AD4302 DOR 125 F17 M	125	40	65	145	140x110	105x80	13.5x11	450	70	189.5	172.5	17	300
AD4302 DOR 125 F17 K	125	40	65	145	140x110	105x80	13.5x11	450	80	189.5	172.5	17	450
AD4302 DOR 150 F17 Y	150	45	65	145	140x110	105x80	13.5x11	700	50	220	201	18	160
AD4302 DOR 150 F17 M	150	45	65	145	140x110	105x80	13.5x11	700	80	220	201	18	300
AD4302 DOR 150 F17 K	150	45	65	145	140x110	105x80	13.5x11	700	100	220	201	18	450
AD4302 DOR 150 F17 S	150	45	65	145	140x110	105x80	13.5x11	700	120	220	201	18	700
AD4302 DOR 200 F17 Y	200	50	70	145	140x110	105x80	13.5x11	1000	70	275	253	22	190
AD4302 DOR 200 F17 M	200	50	70	145	140x110	105x80	13.5x11	1000	90	275	253	22	300
AD4302 DOR 200 F17 K	200	50	70	145	140x110	105x80	13.5x11	1000	110	275	253	22	450
AD4302 DOR 200 F17 S	200	50	70	145	140x110	105x80	13.5x11	1000	130	275	253	22	700



D2OR





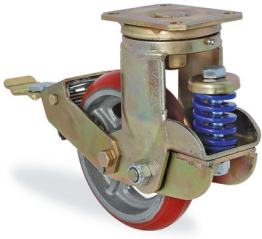

DÖKÜM KASNAK ÜZERİ OVAL DÖKME POLİÜRETAN KAPLAMA RULMANLI

KOD NO							MAKSİMUM TAŞIMA KAPASİTESİ kg	ÖN GERME KUVVETİ kg	H2 TOPLAM YÜKSEKLİK mm	H1 YÜKLÜ TOPLAM YÜKSEKLİK mm	L YAY YOLU mm	YAYIN SON KUVVETİ kg
AD4302 D2OR 100 Y	100	35	65	140x110	105x80	13.5x11	350	40	177	160	17	160
AD4302 D2OR 100 M	100	35	65	140x110	105x80	13.5x11	350	70	177	160	17	300
AD4302 D2OR 100 K	100	35	65	140x110	105x80	13.5x11	350	80	177	160	17	450
AD4302 D2OR 125 Y	125	40	65	140x110	105x80	13.5x11	450	40	189.5	172.5	17	160
AD4302 D2OR 125 M	125	40	65	140x110	105x80	13.5x11	450	70	189.5	172.5	17	300
AD4302 D2OR 125 K	125	40	65	140x110	105x80	13.5x11	450	80	189.5	172.5	17	450
AD4302 D2OR 150 Y	150	45	65	140x110	105x80	13.5x11	700	50	220	201	18	160
AD4302 D2OR 150 M	150	45	65	140x110	105x80	13.5x11	700	80	220	201	18	300
AD4302 D2OR 150 K	150	45	65	140x110	105x80	13.5x11	700	100	220	201	18	450
AD4302 D2OR 150 S	150	45	65	140x110	105x80	13.5x11	700	120	220	201	18	700
AD4302 D2OR 200 Y	200	50	70	140x110	105x80	13.5x11	1000	70	275	253	22	190
AD4302 D2OR 200 M	200	50	70	140x110	105x80	13.5x11	1000	90	275	253	22	300
AD4302 D2OR 200 K	200	50	70	140x110	105x80	13.5x11	1000	110	275	253	22	450
AD4302 D2OR 200 S	200	50	70	140x110	105x80	13.5x11	1000	130	275	253	22	700



D2OR

DÖKÜM KASNAK ÜZERİ OVAL DÖKME POLİÜRETAN KAPLAMA RULMANLI



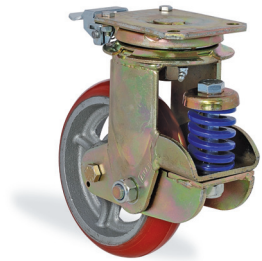



KOD NO	 mm	 mm	 mm	 mm	 mm	 mm	 mm	MAKSİMUM TAŞIMA KAPASİTESİ kg	ÖN GERME KUVVETİ kg	H2 TOPLAM YÜKSEKLİK mm	H1 YÜKLÜ TOPLAM YÜKSEKLİK mm	L YAY YOLU mm	YAYIN SON KUVVETİ kg
AD4302 D2OR 100 F04 Y	100	35	65	247	140x110	105x80	13.5x11	350	40	177	160	17	160
AD4302 D2OR 100 F04 M	100	35	65	247	140x110	105x80	13.5x11	350	70	177	160	17	300
AD4302 D2OR 100 F04 K	100	35	65	247	140x110	105x80	13.5x11	350	80	177	160	17	450
AD4302 D2OR 125 F04 Y	125	40	65	257	140x110	105x80	13.5x11	450	40	189.5	172.5	17	160
AD4302 D2OR 125 F04 M	125	40	65	257	140x110	105x80	13.5x11	450	70	189.5	172.5	17	300
AD4302 D2OR 125 F04 K	125	40	65	257	140x110	105x80	13.5x11	450	80	189.5	172.5	17	450
AD4302 D2OR 150 F04 Y	150	45	65	262	140x110	105x80	13.5x11	700	50	220	201	18	160
AD4302 D2OR 150 F04 M	150	45	65	262	140x110	105x80	13.5x11	700	80	220	201	18	300
AD4302 D2OR 150 F04 K	150	45	65	262	140x110	105x80	13.5x11	700	100	220	201	18	450
AD4302 D2OR 150 F04 S	150	45	65	262	140x110	105x80	13.5x11	700	120	220	201	18	700
AD4302 D2OR 200 F04 Y	200	50	70	290	140x110	105x80	13.5x11	1000	70	275	253	22	190
AD4302 D2OR 200 F04 M	200	50	70	290	140x110	105x80	13.5x11	1000	90	275	253	22	300
AD4302 D2OR 200 F04 K	200	50	70	290	140x110	105x80	13.5x11	1000	110	275	253	22	450
AD4302 D2OR 200 F04 S	200	50	70	290	140x110	105x80	13.5x11	1000	130	275	253	22	700



YÖN KİLİTLİ

D2OR

DÖKÜM KASNAK ÜZERİ OVAL DÖKME POLİÜRETAN KAPLAMA RULMANLI





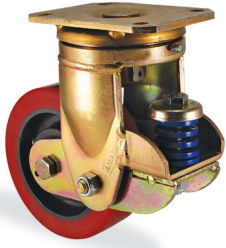

KOD NO	 mm	 mm	 mm	 mm	 mm	 mm	 mm	MAKSİMUM TAŞIMA KAPASİTESİ kg	ÖN GERME KUVVETİ kg	H2 TOPLAM YÜKSEKLİK mm	H1 YÜKLÜ TOPLAM YÜKSEKLİK mm	L YAY YOLU mm	YAYIN SON KUVVETİ kg
AD4302 D2OR 100 F17 Y	100	35	65	145	140x110	105x80	13.5x11	350	40	177	160	17	160
AD4302 D2OR 100 F17 M	100	35	65	145	140x110	105x80	13.5x11	350	70	177	160	17	300
AD4302 D2OR 100 F17 K	100	35	65	145	140x110	105x80	13.5x11	350	80	177	160	17	450
AD4302 D2OR 125 F17 Y	125	40	65	145	140x110	105x80	13.5x11	450	40	189.5	172.5	17	160
AD4302 D2OR 125 F17 M	125	40	65	145	140x110	105x80	13.5x11	450	70	189.5	172.5	17	300
AD4302 D2OR 125 F17 K	125	40	65	145	140x110	105x80	13.5x11	450	80	189.5	172.5	17	450
AD4302 D2OR 150 F17 Y	150	45	65	145	140x110	105x80	13.5x11	700	50	220	201	18	160
AD4302 D2OR 150 F17 M	150	45	65	145	140x110	105x80	13.5x11	700	80	220	201	18	300
AD4302 D2OR 150 F17 K	150	45	65	145	140x110	105x80	13.5x11	700	100	220	201	18	450
AD4302 D2OR 150 F17 S	150	45	65	145	140x110	105x80	13.5x11	700	120	220	201	18	700
AD4302 D2OR 200 F17 Y	200	50	70	145	140x110	105x80	13.5x11	1000	70	275	253	22	190
AD4302 D2OR 200 F17 M	200	50	70	145	140x110	105x80	13.5x11	1000	90	275	253	22	300
AD4302 D2OR 200 F17 K	200	50	70	145	140x110	105x80	13.5x11	1000	110	275	253	22	450
AD4302 D2OR 200 F17 S	200	50	70	145	140x110	105x80	13.5x11	1000	130	275	253	22	700

AD4302 Serisi (Amortisörlü)







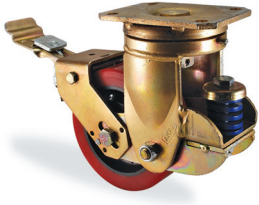

KOR

KAMALON KASNAK ÜZERİ DÖKME POLİÜRETAN KAPLAMA RULMANLI

KOD NO	 mm	 mm	 mm	 mm	 mm	 mm	MAKSİMUM TAŞIMA KAPASİTESİ kg	ÖN GERME KUVVETİ kg	H2 TOPLAM YÜKSEKLİK mm	H1 YÜKLÜ TOPLAM YÜKSEKLİK mm	L YAY YOLU mm	YAYIN SON KUVVETİ kg
AD4302 KOR 100 Y	100	40	65	140x110	105x80	13.5x11	350	40	177	160	17	160
AD4302 KOR 100 M	100	40	65	140x110	105x80	13.5x11	350	70	177	160	17	300
AD4302 KOR 100 K	100	40	65	140x110	105x80	13.5x11	350	80	177	160	17	450
AD4302 KOR 125 Y	125	50	65	140x110	105x80	13.5x11	450	40	189.5	172.5	17	160
AD4302 KOR 125 M	125	50	65	140x110	105x80	13.5x11	450	70	189.5	172.5	17	300
AD4302 KOR 125 K	125	50	65	140x110	105x80	13.5x11	450	80	189.5	172.5	17	450
AD4302 KOR 150 Y	150	50	65	140x110	105x80	13.5x11	700	50	220	201	18	160
AD4302 KOR 150 M	150	50	65	140x110	105x80	13.5x11	700	80	220	201	18	300
AD4302 KOR 150 K	150	50	65	140x110	105x80	13.5x11	700	100	220	201	18	450
AD4302 KOR 150 S	150	50	65	140x110	105x80	13.5x11	700	120	220	201	18	700
AD4302 KOR 160 Y	160	50	70	140x110	105x80	13.5x11	800	70	275	253	22	190
AD4302 KOR 160 M	160	50	70	140x110	105x80	13.5x11	800	90	275	253	22	300
AD4302 KOR 160 K	160	50	70	140x110	105x80	13.5x11	800	110	275	253	22	450
AD4302 KOR 160 S	160	50	70	140x110	105x80	13.5x11	800	130	275	253	22	700
AD4302 KOR 200 Y	200	50	70	140x110	105x80	13.5x11	1000	70	275	253	22	190
AD4302 KOR 200 M	200	50	70	140x110	105x80	13.5x11	1000	90	275	253	22	300
AD4302 KOR 200 K	200	50	70	140x110	105x80	13.5x11	1000	110	275	253	22	450
AD4302 KOR 200 S	200	50	70	140x110	105x80	13.5x11	1000	130	275	253	22	700



KOR		KAMALON KASNAK ÜZERİ DÖKME POLİÜRETAN KAPLAMA RULMANLI											
KOD NO								MAKSİMUM TAŞIMA KAPASİTESİ kg	ÖN GERME KUVVETİ kg	H2 TOPLAM YÜKSEKLİK mm	H1 YÜKLÜ TOPLAM YÜKSEKLİK mm	L YAY YOLU mm	YAYIN SON KUVVETİ kg
AD4302 KOR 100 F04 Y	100	40	65	247	140x110	105x80	13.5x11	350	40	177	160	17	160
AD4302 KOR 100 F04 M	100	40	65	247	140x110	105x80	13.5x11	350	70	177	160	17	300
AD4302 KOR 100 F04 K	100	40	65	247	140x110	105x80	13.5x11	350	80	177	160	17	450
AD4302 KOR 125 F04 Y	125	50	65	257	140x110	105x80	13.5x11	450	40	189.5	172.5	17	160
AD4302 KOR 125 F04 M	125	50	65	257	140x110	105x80	13.5x11	450	70	189.5	172.5	17	300
AD4302 KOR 125 F04 K	125	50	65	257	140x110	105x80	13.5x11	450	80	189.5	172.5	17	450
AD4302 KOR 150 F04 Y	150	50	65	262	140x110	105x80	13.5x11	700	50	220	201	18	160
AD4302 KOR 150 F04 M	150	50	65	262	140x110	105x80	13.5x11	700	80	220	201	18	300
AD4302 KOR 150 F04 K	150	50	65	262	140x110	105x80	13.5x11	700	100	220	201	18	450
AD4302 KOR 150 F04 S	150	50	65	262	140x110	105x80	13.5x11	700	120	220	201	18	700
AD4302 KOR 160 F04 Y	160	50	70	290	140x110	105x80	13.5x11	800	70	275	253	22	190
AD4302 KOR 160 F04 M	160	50	70	290	140x110	105x80	13.5x11	800	90	275	253	22	300
AD4302 KOR 160 F04 K	160	50	70	290	140x110	105x80	13.5x11	800	110	275	253	22	450
AD4302 KOR 160 F04 S	160	50	70	290	140x110	105x80	13.5x11	800	130	275	253	22	700
AD4302 KOR 200 F04 Y	200	50	70	290	140x110	105x80	13.5x11	1000	70	275	253	22	190
AD4302 KOR 200 F04 M	200	50	70	290	140x110	105x80	13.5x11	1000	90	275	253	22	300
AD4302 KOR 200 F04 K	200	50	70	290	140x110	105x80	13.5x11	1000	110	275	253	22	450
AD4302 KOR 200 F04 S	200	50	70	290	140x110	105x80	13.5x11	1000	130	275	253	22	700



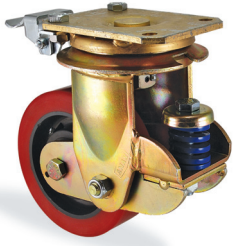



AD4302 Serisi (Amortisörlü)



YÖN KİLİTLİ

KOR





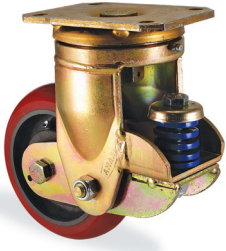

KAMALON KASNAK ÜZERİ DÖKME POLİÜRETAN KAPLAMA RULMANLI

KOD NO	 mm	 mm	 mm	 mm	 mm	 mm	 mm	MAKSİMUM TAŞIMA KAPASİTESİ kg	ÖN GERME KUVVETİ kg	H2 TOPLAM YÜKSEKLİK mm	H1 YÜKLÜ TOPLAM YÜKSEKLİK mm	L YAY YOLU mm	YAYIN SON KUVVETİ kg
AD4302 KOR 100 F17 Y	100	40	65	145	140x110	105x80	13.5x11	350	40	177	160	17	160
AD4302 KOR 100 F17 M	100	40	65	145	140x110	105x80	13.5x11	350	70	177	160	17	300
AD4302 KOR 100 F17 K	100	40	65	145	140x110	105x80	13.5x11	350	80	177	160	17	450
AD4302 KOR 125 F17 Y	125	50	65	145	140x110	105x80	13.5x11	450	40	189.5	172.5	17	160
AD4302 KOR 125 F17 M	125	50	65	145	140x110	105x80	13.5x11	450	70	189.5	172.5	17	300
AD4302 KOR 125 F17 K	125	50	65	145	140x110	105x80	13.5x11	450	80	189.5	172.5	17	450
AD4302 KOR 150 F17 Y	150	50	65	145	140x110	105x80	13.5x11	700	50	220	201	18	160
AD4302 KOR 150 F17 M	150	50	65	145	140x110	105x80	13.5x11	700	80	220	201	18	300
AD4302 KOR 150 F17 K	150	50	65	145	140x110	105x80	13.5x11	700	100	220	201	18	450
AD4302 KOR 150 F17 S	150	50	65	145	140x110	105x80	13.5x11	700	120	220	201	18	700
AD4302 KOR 160 F17 Y	160	50	70	145	140x110	105x80	13.5x11	800	70	275	253	22	190
AD4302 KOR 160 F17 M	160	50	70	145	140x110	105x80	13.5x11	800	90	275	253	22	300
AD4302 KOR 160 F17 K	160	50	70	145	140x110	105x80	13.5x11	800	110	275	253	22	450
AD4302 KOR 160 F17 S	160	50	70	145	140x110	105x80	13.5x11	800	130	275	253	22	700
AD4302 KOR 200 F17 Y	200	50	70	145	140x110	105x80	13.5x11	1000	70	275	253	22	190
AD4302 KOR 200 F17 M	200	50	70	145	140x110	105x80	13.5x11	1000	90	275	253	22	300
AD4302 KOR 200 F17 K	200	50	70	145	140x110	105x80	13.5x11	1000	110	275	253	22	450
AD4302 KOR 200 F17 S	200	50	70	145	140x110	105x80	13.5x11	1000	130	275	253	22	700







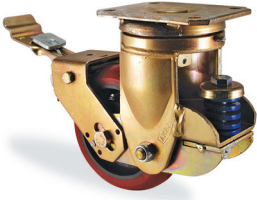

K2OR

KAMALON KASNAK ÜZERİ OVAL DÖKME POLİÜRETAN KAPLAMA RULMANLI

KOD NO	 mm	 mm	 mm	 mm	 mm	 mm	MAKSİMUM TAŞIMA KAPASİTESİ kg	ÖN GERME KUVVETİ kg	H2 TOPLAM YÜKSEKLİK mm	H1 YÜKLÜ TOPLAM YÜKSEKLİK mm	L YAY YOLU mm	YAYIN SON KUVVETİ kg
AD4302 K2OR 100 Y	100	40	65	140x110	105x80	13.5x11	350	40	177	160	17	160
AD4302 K2OR 100 M	100	40	65	140x110	105x80	13.5x11	350	70	177	160	17	300
AD4302 K2OR 100 K	100	40	65	140x110	105x80	13.5x11	350	80	177	160	17	450
AD4302 K2OR 125 Y	125	50	65	140x110	105x80	13.5x11	450	40	189.5	172.5	17	160
AD4302 K2OR 125 M	125	50	65	140x110	105x80	13.5x11	450	70	189.5	172.5	17	300
AD4302 K2OR 125 K	125	50	65	140x110	105x80	13.5x11	450	80	189.5	172.5	17	450
AD4302 K2OR 150 Y	150	50	65	140x110	105x80	13.5x11	700	50	220	201	18	160
AD4302 K2OR 150 M	150	50	65	140x110	105x80	13.5x11	700	80	220	201	18	300
AD4302 K2OR 150 K	150	50	65	140x110	105x80	13.5x11	700	100	220	201	18	450
AD4302 K2OR 150 S	150	50	65	140x110	105x80	13.5x11	700	120	220	201	18	700
AD4302 K2OR 160 Y	160	50	70	140x110	105x80	13.5x11	800	70	275	253	22	190
AD4302 K2OR 160 M	160	50	70	140x110	105x80	13.5x11	800	90	275	253	22	300
AD4302 K2OR 160 K	160	50	70	140x110	105x80	13.5x11	800	110	275	253	22	450
AD4302 K2OR 160 S	160	50	70	140x110	105x80	13.5x11	800	130	275	253	22	700
AD4302 K2OR 200 Y	200	50	70	140x110	105x80	13.5x11	1000	70	275	253	22	190
AD4302 K2OR 200 M	200	50	70	140x110	105x80	13.5x11	1000	90	275	253	22	300
AD4302 K2OR 200 K	200	50	70	140x110	105x80	13.5x11	1000	110	275	253	22	450
AD4302 K2OR 200 S	200	50	70	140x110	105x80	13.5x11	1000	130	275	253	22	700

K2OR
KAMALON KASNAK ÜZERİ OVAL DÖKME POLİÜRETAN KAPLAMA RULMANLI



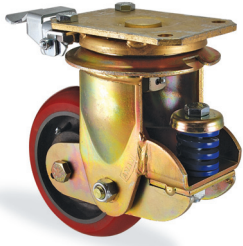



KOD NO	 mm	 mm	 mm	 mm	 mm	 mm	 mm	MAKSİMUM TAŞIMA KAPASİTESİ kg	ÖN GERME KUVVETİ kg	H2 TOPLAM YÜKSEKLİK mm	H1 YÜKLÜ TOPLAM YÜKSEKLİK mm	L YAY YOLU mm	YAYIN SON KUVVETİ kg
AD4302 K2OR 100 F04 Y	100	40	65	247	140x110	105x80	13.5x11	350	40	177	160	17	160
AD4302 K2OR 100 F04 M	100	40	65	247	140x110	105x80	13.5x11	350	70	177	160	17	300
AD4302 K2OR 100 F04 K	100	40	65	247	140x110	105x80	13.5x11	350	80	177	160	17	450
AD4302 K2OR 125 F04 Y	125	50	65	257	140x110	105x80	13.5x11	450	40	189.5	172.5	17	160
AD4302 K2OR 125 F04 M	125	50	65	257	140x110	105x80	13.5x11	450	70	189.5	172.5	17	300
AD4302 K2OR 125 F04 K	125	50	65	257	140x110	105x80	13.5x11	450	80	189.5	172.5	17	450
AD4302 K2OR 150 F04 Y	150	50	65	262	140x110	105x80	13.5x11	700	50	220	201	18	160
AD4302 K2OR 150 F04 M	150	50	65	262	140x110	105x80	13.5x11	700	80	220	201	18	300
AD4302 K2OR 150 F04 K	150	50	65	262	140x110	105x80	13.5x11	700	100	220	201	18	450
AD4302 K2OR 150 F04 S	150	50	65	262	140x110	105x80	13.5x11	700	120	220	201	18	700
AD4302 K2OR 160 F04 Y	160	50	70	290	140x110	105x80	13.5x11	800	70	275	253	22	190
AD4302 K2OR 160 F04 M	160	50	70	290	140x110	105x80	13.5x11	800	90	275	253	22	300
AD4302 K2OR 160 F04 K	160	50	70	290	140x110	105x80	13.5x11	800	110	275	253	22	450
AD4302 K2OR 160 F04 S	160	50	70	290	140x110	105x80	13.5x11	800	130	275	253	22	700
AD4302 K2OR 200 F04 Y	200	50	70	290	140x110	105x80	13.5x11	1000	70	275	253	22	190
AD4302 K2OR 200 F04 M	200	50	70	290	140x110	105x80	13.5x11	1000	90	275	253	22	300
AD4302 K2OR 200 F04 K	200	50	70	290	140x110	105x80	13.5x11	1000	110	275	253	22	450
AD4302 K2OR 200 F04 S	200	50	70	290	140x110	105x80	13.5x11	1000	130	275	253	22	700



YÖN KİLİTLİ

K2OR







KAMALON KASNAK ÜZERİ OVAL DÖKME POLİÜRETAN KAPLAMA RULMANLI

KOD NO	 mm	 mm	 mm	 mm	 mm	 mm	MAKSİMUM TAŞIMA KAPASİTESİ kg	ÖN GERME KUVVETİ kg	H2 TOPLAM YÜKSEKLİK mm	H1 YÜKLÜ TOPLAM YÜKSEKLİK mm	L YAY YOLU mm	YAYIN SON KUVVETİ kg	
AD4302 K2OR 100 F17 Y	100	40	65	145	140x110	105x80	13.5x11	350	40	177	160	17	160
AD4302 K2OR 100 F17 M	100	40	65	145	140x110	105x80	13.5x11	350	70	177	160	17	300
AD4302 K2OR 100 F17 K	100	40	65	145	140x110	105x80	13.5x11	350	80	177	160	17	450
AD4302 K2OR 125 F17 Y	125	50	65	145	140x110	105x80	13.5x11	450	40	189.5	172.5	17	160
AD4302 K2OR 125 F17 M	125	50	65	145	140x110	105x80	13.5x11	450	70	189.5	172.5	17	300
AD4302 K2OR 125 F17 K	125	50	65	145	140x110	105x80	13.5x11	450	80	189.5	172.5	17	450
AD4302 K2OR 150 F17 Y	150	50	65	145	140x110	105x80	13.5x11	700	50	220	201	18	160
AD4302 K2OR 150 F17 M	150	50	65	145	140x110	105x80	13.5x11	700	80	220	201	18	300
AD4302 K2OR 150 F17 K	150	50	65	145	140x110	105x80	13.5x11	700	100	220	201	18	450
AD4302 K2OR 150 F17 S	150	50	65	145	140x110	105x80	13.5x11	700	120	220	201	18	700
AD4302 K2OR 160 F17 Y	160	50	70	145	140x110	105x80	13.5x11	800	70	275	253	22	190
AD4302 K2OR 160 F17 M	160	50	70	145	140x110	105x80	13.5x11	800	90	275	253	22	300
AD4302 K2OR 160 F17 K	160	50	70	145	140x110	105x80	13.5x11	800	110	275	253	22	450
AD4302 K2OR 160 F17 S	160	50	70	145	140x110	105x80	13.5x11	800	130	275	253	22	700
AD4302 K2OR 200 F17 Y	200	50	70	145	140x110	105x80	13.5x11	1000	70	275	253	22	190
AD4302 K2OR 200 F17 M	200	50	70	145	140x110	105x80	13.5x11	1000	90	275	253	22	300
AD4302 K2OR 200 F17 K	200	50	70	145	140x110	105x80	13.5x11	1000	110	275	253	22	450
AD4302 K2OR 200 F17 S	200	50	70	145	140x110	105x80	13.5x11	1000	130	275	253	22	700









DYR

DÖKÜM KASNAK ÜZERİ VULKANİZE LASTİK KAPLAMA RULMANLI

KOD NO	 mm	 mm	 mm	 mm	 mm	 mm	MAKSİMUM TAŞIMA KAPASİTESİ kg	ÖN GERME KUVVETİ kg	H2 TOPLAM YÜKSEKLİK mm	H1 YÜKLÜ TOPLAM YÜKSEKLİK mm	L YAY YOLU mm	YAYIN SON KUVVETİ kg
AD4302 DYR 100 Y	100	35	65	140x110	105x80	13.5x11	140	40	177	160	17	160
AD4302 DYR 100 M	100	35	65	140x110	105x80	13.5x11	140	70	177	160	17	300
AD4302 DYR 100 K	100	35	65	140x110	105x80	13.5x11	140	80	177	160	17	450
AD4302 DYR 125 Y	125	40	65	140x110	105x80	13.5x11	180	40	189.5	172.5	17	160
AD4302 DYR 125 M	125	40	65	140x110	105x80	13.5x11	180	70	189.5	172.5	17	300
AD4302 DYR 125 K	125	40	65	140x110	105x80	13.5x11	180	80	189.5	172.5	17	450
AD4302 DYR 150 Y	150	45	65	140x110	105x80	13.5x11	200	50	220	201	18	160
AD4302 DYR 150 M	150	45	65	140x110	105x80	13.5x11	200	80	220	201	18	300
AD4302 DYR 150 K	150	45	65	140x110	105x80	13.5x11	200	100	220	201	18	450
AD4302 DYR 150 S	150	45	65	140x110	105x80	13.5x11	200	120	220	201	18	700
AD4302 DYR 200 Y	200	50	70	140x110	105x80	13.5x11	350	70	275	253	22	190
AD4302 DYR 200 M	200	50	70	140x110	105x80	13.5x11	350	90	275	253	22	300
AD4302 DYR 200 K	200	50	70	140x110	105x80	13.5x11	350	110	275	253	22	450
AD4302 DYR 200 S	200	50	70	140x110	105x80	13.5x11	350	130	275	253	22	700





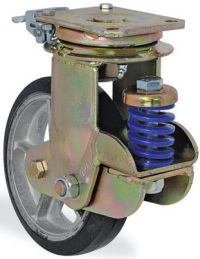

AD4302 Serisi (Amortisörlü)









DYZ		DÖKÜM KASNAK ÜZERİ VULKANİZE LASTİK KAPLAMA RULMANLI											
KOD NO								MAKSİMUM TAŞIMA KAPASİTESİ kg	ÖN GERME KUVVETİ kg	H2 TOPLAM YÜKSEKLİK mm	H1 YÜKLÜ TOPLAM YÜKSEKLİK mm	L YAY YOLU mm	YAYIN SON KUVVETİ kg
AD4302 DYZ 100 F04 Y	100	35	65	247	140x110	105x80	13.5x11	140	40	177	160	17	160
AD4302 DYZ 100 F04 M	100	35	65	247	140x110	105x80	13.5x11	140	70	177	160	17	300
AD4302 DYZ 100 F04 K	100	35	65	247	140x110	105x80	13.5x11	140	80	177	160	17	450
AD4302 DYZ 125 F04 Y	125	40	65	257	140x110	105x80	13.5x11	180	40	189.5	172.5	17	160
AD4302 DYZ 125 F04 M	125	40	65	257	140x110	105x80	13.5x11	180	70	189.5	172.5	17	300
AD4302 DYZ 125 F04 K	125	40	65	257	140x110	105x80	13.5x11	180	80	189.5	172.5	17	450
AD4302 DYZ 150 F04 Y	150	45	65	262	140x110	105x80	13.5x11	200	50	220	201	18	160
AD4302 DYZ 150 F04 M	150	45	65	262	140x110	105x80	13.5x11	200	80	220	201	18	300
AD4302 DYZ 150 F04 K	150	45	65	262	140x110	105x80	13.5x11	200	100	220	201	18	450
AD4302 DYZ 150 F04 S	150	45	65	262	140x110	105x80	13.5x11	200	120	220	201	18	700
AD4302 DYZ 200 F04 Y	200	50	70	290	140x110	105x80	13.5x11	350	70	275	253	22	190
AD4302 DYZ 200 F04 M	200	50	70	290	140x110	105x80	13.5x11	350	90	275	253	22	300
AD4302 DYZ 200 F04 K	200	50	70	290	140x110	105x80	13.5x11	350	110	275	253	22	450
AD4302 DYZ 200 F04 S	200	50	70	290	140x110	105x80	13.5x11	350	130	275	253	22	700



YÖN KİLİTLİ

DYZ		DÖKÜM KASNAK ÜZERİ VULKANİZE LASTİK KAPLAMA RULMANLI											
KOD NO								MAKSİMUM TAŞIMA KAPASİTESİ kg	ÖN GERME KUVVETİ kg	H2 TOPLAM YÜKSEKLİK mm	H1 YÜKLÜ TOPLAM YÜKSEKLİK mm	L YAY YOLU mm	YAYIN SON KUVVETİ kg
AD4302 DYZ 100 F17 Y	100	35	65	145	140x110	105x80	13.5x11	140	40	177	160	17	160
AD4302 DYZ 100 F17 M	100	35	65	145	140x110	105x80	13.5x11	140	70	177	160	17	300
AD4302 DYZ 100 F17 K	100	35	65	145	140x110	105x80	13.5x11	140	80	177	160	17	450
AD4302 DYZ 125 F17 Y	125	40	65	145	140x110	105x80	13.5x11	180	40	189.5	172.5	17	160
AD4302 DYZ 125 F17 M	125	40	65	145	140x110	105x80	13.5x11	180	70	189.5	172.5	17	300
AD4302 DYZ 125 F17 K	125	40	65	145	140x110	105x80	13.5x11	180	80	189.5	172.5	17	450
AD4302 DYZ 150 F17 Y	150	45	65	145	140x110	105x80	13.5x11	200	50	220	201	18	160
AD4302 DYZ 150 F17 M	150	45	65	145	140x110	105x80	13.5x11	200	80	220	201	18	300
AD4302 DYZ 150 F17 K	150	45	65	145	140x110	105x80	13.5x11	200	100	220	201	18	450
AD4302 DYZ 150 F17 S	150	45	65	145	140x110	105x80	13.5x11	200	120	220	201	18	700
AD4302 DYZ 200 F17 Y	200	50	70	145	140x110	105x80	13.5x11	350	70	275	253	22	190
AD4302 DYZ 200 F17 M	200	50	70	145	140x110	105x80	13.5x11	350	90	275	253	22	300
AD4302 DYZ 200 F17 K	200	50	70	145	140x110	105x80	13.5x11	350	110	275	253	22	450
AD4302 DYZ 200 F17 S	200	50	70	145	140x110	105x80	13.5x11	350	130	275	253	22	700









KYR		KAMALON KASNAK ÜZERİ VULKANİZE SİYAH LASTİK KAPLAMA RULMANLI										
KOD NO	 mm	 mm	 mm	 mm	 mm	 mm	MAKSİMUM TAŞIMA KAPASİTESİ kg	ÖN GERME KUVVETİ kg	H2 TOPLAM YÜKSEKLİK mm	H1 YÜKLÜ TOPLAM YÜKSEKLİK mm	L YAY YOLU mm	YAYIN SON KUVVETİ kg
AD4302 KYR 100 Y	100	40	65	140x110	105x80	13.5x11	140	40	177	160	17	160
AD4302 KYR 100 M	100	40	65	140x110	105x80	13.5x11	140	70	177	160	17	300
AD4302 KYR 100 K	100	40	65	140x110	105x80	13.5x11	140	80	177	160	17	450
AD4302 KYR 125 Y	125	40	65	140x110	105x80	13.5x11	180	40	189.5	172.5	17	160
AD4302 KYR 125 M	125	40	65	140x110	105x80	13.5x11	180	70	189.5	172.5	17	300
AD4302 KYR 125 K	125	40	65	140x110	105x80	13.5x11	180	80	189.5	172.5	17	450
AD4302 KYR 150 Y	150	45	65	140x110	105x80	13.5x11	200	50	220	201	18	160
AD4302 KYR 150 M	150	45	65	140x110	105x80	13.5x11	200	80	220	201	18	300
AD4302 KYR 150 K	150	45	65	140x110	105x80	13.5x11	200	100	220	201	18	450
AD4302 KYR 150 S	150	45	65	140x110	105x80	13.5x11	200	120	220	201	18	700
AD4302 KYR 160 Y	160	50	70	140x110	105x80	13.5x11	240	70	275	253	22	190
AD4302 KYR 160 M	160	50	70	140x110	105x80	13.5x11	240	90	275	253	22	300
AD4302 KYR 160 K	160	50	70	140x110	105x80	13.5x11	240	110	275	253	22	450
AD4302 KYR 160 S	160	50	70	140x110	105x80	13.5x11	240	130	275	253	22	700
AD4302 KYR 200 Y	200	50	70	140x110	105x80	13.5x11	350	70	275	253	22	190
AD4302 KYR 200 M	200	50	70	140x110	105x80	13.5x11	350	90	275	253	22	300
AD4302 KYR 200 K	200	50	70	140x110	105x80	13.5x11	350	110	275	253	22	450
AD4302 KYR 200 S	200	50	70	140x110	105x80	13.5x11	350	130	275	253	22	700







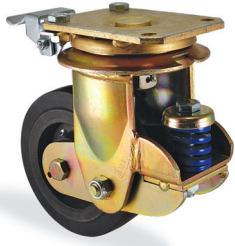

KYR

KAMALON KASNAK ÜZERİ VULKANİZE SİYAH LASTİK KAPLAMA RULMANLI

KOD NO	 mm	 mm	 mm	 mm	 mm	 mm	 mm	MAKSİMUM TAŞIMA KAPASİTESİ kg	ÖN GERME KUVVETİ kg	H2 TOPLAM YÜKSEKLİK mm	H1 YÜKLÜ TOPLAM YÜKSEKLİK mm	L YAY YOLU mm	YAYIN SON KUVVETİ kg
AD4302 KYR 100 F04 Y	100	40	65	247	140x110	105x80	13.5x11	140	40	177	160	17	160
AD4302 KYR 100 F04 M	100	40	65	247	140x110	105x80	13.5x11	140	70	177	160	17	300
AD4302 KYR 100 F04 K	100	40	65	247	140x110	105x80	13.5x11	140	80	177	160	17	450
AD4302 KYR 125 F04 Y	125	40	65	257	140x110	105x80	13.5x11	180	40	189.5	172.5	17	160
AD4302 KYR 125 F04 M	125	40	65	257	140x110	105x80	13.5x11	180	70	189.5	172.5	17	300
AD4302 KYR 125 F04 K	125	40	65	257	140x110	105x80	13.5x11	180	80	189.5	172.5	17	450
AD4302 KYR 150 F04 Y	150	45	65	262	140x110	105x80	13.5x11	200	50	220	201	18	160
AD4302 KYR 150 F04 M	150	45	65	262	140x110	105x80	13.5x11	200	80	220	201	18	300
AD4302 KYR 150 F04 K	150	45	65	262	140x110	105x80	13.5x11	200	100	220	201	18	450
AD4302 KYR 150 F04 S	150	45	65	262	140x110	105x80	13.5x11	200	120	220	201	18	700
AD4302 KYR 160 F04 Y	160	50	70	290	140x110	105x80	13.5x11	240	70	275	253	22	190
AD4302 KYR 160 F04 M	160	50	70	290	140x110	105x80	13.5x11	240	90	275	253	22	300
AD4302 KYR 160 F04 K	160	50	70	290	140x110	105x80	13.5x11	240	110	275	253	22	450
AD4302 KYR 160 F04 S	160	50	70	290	140x110	105x80	13.5x11	240	130	275	253	22	700
AD4302 KYR 200 F04 Y	200	50	70	290	140x110	105x80	13.5x11	350	70	275	253	22	190
AD4302 KYR 200 F04 M	200	50	70	290	140x110	105x80	13.5x11	350	90	275	253	22	300
AD4302 KYR 200 F04 K	200	50	70	290	140x110	105x80	13.5x11	350	110	275	253	22	450
AD4302 KYR 200 F04 S	200	50	70	290	140x110	105x80	13.5x11	350	130	275	253	22	700









YÖN KİLİTLİ







KYR		KAMALON KASNAK ÜZERİ VULKANİZE SİYAH LASTİK KAPLAMA RULMANLI											
KOD NO								MAKSİMUM TAŞIMA KAPASİTESİ kg	ÖN GERME KUVVETİ kg	H2 TOPLAM YÜKSEKLİK mm	H1 YÜKLÜ TOPLAM YÜKSEKLİK mm	L YAY YOLU mm	YAYIN SON KUVVETİ kg
AD4302 KYR 100 F17 Y	100	40	65	145	140x110	105x80	13.5x11	140	40	177	160	17	160
AD4302 KYR 100 F17 M	100	40	65	145	140x110	105x80	13.5x11	140	70	177	160	17	300
AD4302 KYR 100 F17 K	100	40	65	145	140x110	105x80	13.5x11	140	80	177	160	17	450
AD4302 KYR 125 F17 Y	125	40	65	145	140x110	105x80	13.5x11	180	40	189.5	172.5	17	160
AD4302 KYR 125 F17 M	125	40	65	145	140x110	105x80	13.5x11	180	70	189.5	172.5	17	300
AD4302 KYR 125 F17 K	125	40	65	145	140x110	105x80	13.5x11	180	80	189.5	172.5	17	450
AD4302 KYR 150 F17 Y	150	45	65	145	140x110	105x80	13.5x11	200	50	220	201	18	160
AD4302 KYR 150 F17 M	150	45	65	145	140x110	105x80	13.5x11	200	80	220	201	18	300
AD4302 KYR 150 F17 K	150	45	65	145	140x110	105x80	13.5x11	200	100	220	201	18	450
AD4302 KYR 150 F17 S	150	45	65	145	140x110	105x80	13.5x11	200	120	220	201	18	700
AD4302 KYR 160 F17 Y	160	50	70	145	140x110	105x80	13.5x11	240	70	275	253	22	190
AD4302 KYR 160 F17 M	160	50	70	145	140x110	105x80	13.5x11	240	90	275	253	22	300
AD4302 KYR 160 F17 K	160	50	70	145	140x110	105x80	13.5x11	240	110	275	253	22	450
AD4302 KYR 160 F17 S	160	50	70	145	140x110	105x80	13.5x11	240	130	275	253	22	700
AD4302 KYR 200 F17 Y	200	50	70	145	140x110	105x80	13.5x11	350	70	275	253	22	190
AD4302 KYR 200 F17 M	200	50	70	145	140x110	105x80	13.5x11	350	90	275	253	22	300
AD4302 KYR 200 F17 K	200	50	70	145	140x110	105x80	13.5x11	350	110	275	253	22	450
AD4302 KYR 200 F17 S	200	50	70	145	140x110	105x80	13.5x11	350	130	275	253	22	700

AD4302 Serisi (Amortisörlü)



KER		KAMALON KASNAK ÜZERİ VULKANİZE GRİ LASTİK KAPLAMA RULMANLI										
KOD NO	 mm	 mm	 mm	 mm	 mm	 mm	MAKSİMUM TAŞIMA KAPASİTESİ kg	ÖN GERME KUVVETİ kg	H2 TOPLAM YÜKSEKLİK mm	H1 YÜKLÜ TOPLAM YÜKSEKLİK mm	L YAY YOLU mm	YAYIN SON KUVVETİ kg
AD4302 KER 100 Y	100	40	65	140x110	105x80	13.5x11	140	40	177	160	17	160
AD4302 KER 100 M	100	40	65	140x110	105x80	13.5x11	140	70	177	160	17	300
AD4302 KER 100 K	100	40	65	140x110	105x80	13.5x11	140	80	177	160	17	450
AD4302 KER 125 Y	125	40	65	140x110	105x80	13.5x11	180	40	189.5	172.5	17	160
AD4302 KER 125 M	125	40	65	140x110	105x80	13.5x11	180	70	189.5	172.5	17	300
AD4302 KER 125 K	125	40	65	140x110	105x80	13.5x11	180	80	189.5	172.5	17	450
AD4302 KER 150 Y	150	45	65	140x110	105x80	13.5x11	200	50	220	201	18	160
AD4302 KER 150 M	150	45	65	140x110	105x80	13.5x11	200	80	220	201	18	300
AD4302 KER 150 K	150	45	65	140x110	105x80	13.5x11	200	100	220	201	18	450
AD4302 KER 150 S	150	45	65	140x110	105x80	13.5x11	200	120	220	201	18	700
AD4302 KER 160 Y	160	50	70	140x110	105x80	13.5x11	240	70	275	253	22	190
AD4302 KER 160 M	160	50	70	140x110	105x80	13.5x11	240	90	275	253	22	300
AD4302 KER 160 K	160	50	70	140x110	105x80	13.5x11	240	110	275	253	22	450
AD4302 KER 160 S	160	50	70	140x110	105x80	13.5x11	240	130	275	253	22	700
AD4302 KER 200 Y	200	50	70	140x110	105x80	13.5x11	350	70	275	253	22	190
AD4302 KER 200 M	200	50	70	140x110	105x80	13.5x11	350	90	275	253	22	300
AD4302 KER 200 K	200	50	70	140x110	105x80	13.5x11	350	110	275	253	22	450
AD4302 KER 200 S	200	50	70	140x110	105x80	13.5x11	350	130	275	253	22	700







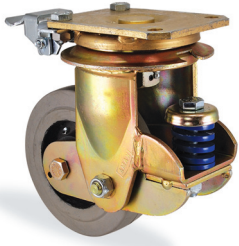

KER		KAMALON KASNAK ÜZERİ VULKANİZE GRİ LASTİK KAPLAMA RULMANLI											
KOD NO								MAKSİMUM TAŞIMA KAPASİTESİ kg	ÖN GERME KUVVETİ kg	H2 TOPLAM YÜKSEKLİK mm	H1 YÜKLÜ TOPLAM YÜKSEKLİK mm	L YAY YOLU mm	YAYIN SON KUVVETİ kg
AD4302 KER 100 F04 Y	100	40	65	247	140x110	105x80	13.5x11	140	40	177	160	17	160
AD4302 KER 100 F04 M	100	40	65	247	140x110	105x80	13.5x11	140	70	177	160	17	300
AD4302 KER 100 F04 K	100	40	65	247	140x110	105x80	13.5x11	140	80	177	160	17	450
AD4302 KER 125 F04 Y	125	40	65	257	140x110	105x80	13.5x11	180	40	189.5	172.5	17	160
AD4302 KER 125 F04 M	125	40	65	257	140x110	105x80	13.5x11	180	70	189.5	172.5	17	300
AD4302 KER 125 F04 K	125	40	65	257	140x110	105x80	13.5x11	180	80	189.5	172.5	17	450
AD4302 KER 150 F04 Y	150	45	65	262	140x110	105x80	13.5x11	200	50	220	201	18	160
AD4302 KER 150 F04 M	150	45	65	262	140x110	105x80	13.5x11	200	80	220	201	18	300
AD4302 KER 150 F04 K	150	45	65	262	140x110	105x80	13.5x11	200	100	220	201	18	450
AD4302 KER 150 F04 S	150	45	65	262	140x110	105x80	13.5x11	200	120	220	201	18	700
AD4302 KER 160 F04 Y	160	50	70	290	140x110	105x80	13.5x11	240	70	275	253	22	190
AD4302 KER 160 F04 M	160	50	70	290	140x110	105x80	13.5x11	240	90	275	253	22	300
AD4302 KER 160 F04 K	160	50	70	290	140x110	105x80	13.5x11	240	110	275	253	22	450
AD4302 KER 160 F04 S	160	50	70	290	140x110	105x80	13.5x11	240	130	275	253	22	700
AD4302 KER 200 F04 Y	200	50	70	290	140x110	105x80	13.5x11	350	70	275	253	22	190
AD4302 KER 200 F04 M	200	50	70	290	140x110	105x80	13.5x11	350	90	275	253	22	300
AD4302 KER 200 F04 K	200	50	70	290	140x110	105x80	13.5x11	350	110	275	253	22	450
AD4302 KER 200 F04 S	200	50	70	290	140x110	105x80	13.5x11	350	130	275	253	22	700







AD4302 Serisi (Amortisörlü)

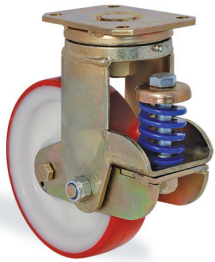







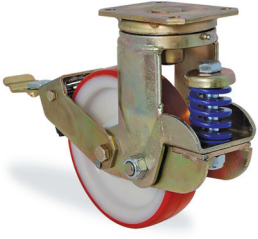

YÖN KİLİTLİ

KER		KAMALON KASNAK ÜZERİ VULKANİZE GRİ LASTİK KAPLAMA RULMANLI											
KOD NO								MAKSİMUM TAŞIMA KAPASİTESİ	ÖN GERME KUVVETİ	H2 TOPLAM YÜKSEKLİK	H1 YÜKLÜ TOPLAM YÜKSEKLİK	L YAY YOLU	YAYIN SON KUVVETİ
	mm	mm	mm	mm	mm	mm	mm	kg	kg	mm	mm	mm	kg
AD4302 KER 100 F17 Y	100	40	65	145	140x110	105x80	13.5x11	140	40	177	160	17	160
AD4302 KER 100 F17 M	100	40	65	145	140x110	105x80	13.5x11	140	70	177	160	17	300
AD4302 KER 100 F17 K	100	40	65	145	140x110	105x80	13.5x11	140	80	177	160	17	450
AD4302 KER 125 F17 Y	125	40	65	145	140x110	105x80	13.5x11	180	40	189.5	172.5	17	160
AD4302 KER 125 F17 M	125	40	65	145	140x110	105x80	13.5x11	180	70	189.5	172.5	17	300
AD4302 KER 125 F17 K	125	40	65	145	140x110	105x80	13.5x11	180	80	189.5	172.5	17	450
AD4302 KER 150 F17 Y	150	45	65	145	140x110	105x80	13.5x11	200	50	220	201	18	160
AD4302 KER 150 F17 M	150	45	65	145	140x110	105x80	13.5x11	200	80	220	201	18	300
AD4302 KER 150 F17 K	150	45	65	145	140x110	105x80	13.5x11	200	100	220	201	18	450
AD4302 KER 150 F17 S	150	45	65	145	140x110	105x80	13.5x11	200	120	220	201	18	700
AD4302 KER 160 F17 Y	160	50	70	145	140x110	105x80	13.5x11	240	70	275	253	22	190
AD4302 KER 160 F17 M	160	50	70	145	140x110	105x80	13.5x11	240	90	275	253	22	300
AD4302 KER 160 F17 K	160	50	70	145	140x110	105x80	13.5x11	240	110	275	253	22	450
AD4302 KER 160 F17 S	160	50	70	145	140x110	105x80	13.5x11	240	130	275	253	22	700
AD4302 KER 200 F17 Y	200	50	70	145	140x110	105x80	13.5x11	350	70	275	253	22	190
AD4302 KER 200 F17 M	200	50	70	145	140x110	105x80	13.5x11	350	90	275	253	22	300
AD4302 KER 200 F17 K	200	50	70	145	140x110	105x80	13.5x11	350	110	275	253	22	450
AD4302 KER 200 F17 S	200	50	70	145	140x110	105x80	13.5x11	350	130	275	253	22	700







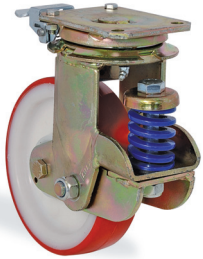

PUR		POLİAMİD KASNAK ÜZERİ POLİÜRETAN KAPLAMA RULMANLI											
KOD NO								MAKSİMUM TAŞIMA KAPASİTESİ	ÖN GERME KUVVETİ	H2 TOPLAM YÜKSEKLİK	H1 YÜKLÜ TOPLAM YÜKSEKLİK	L YAY YOLU	YAYIN SON KUVVETİ
	mm	mm	mm	mm	mm	mm	mm	kg	kg	mm	mm	mm	kg
AD4302 PUR 100 Y	100	35	65	140x110	105x80	13.5x11	200	40	177	160	17	160	
AD4302 PUR 100 M	100	35	65	140x110	105x80	13.5x11	200	70	177	160	17	300	
AD4302 PUR 100 K	100	35	65	140x110	105x80	13.5x11	200	80	177	160	17	450	
AD4302 PUR 125 Y	125	40	65	140x110	105x80	13.5x11	250	40	189.5	172.5	17	160	
AD4302 PUR 125 M	125	40	65	140x110	105x80	13.5x11	250	70	189.5	172.5	17	300	
AD4302 PUR 125 K	125	40	65	140x110	105x80	13.5x11	250	80	189.5	172.5	17	450	
AD4302 PUR 150 Y	150	45	65	140x110	105x80	13.5x11	400	50	220	201	18	160	
AD4302 PUR 150 M	150	45	65	140x110	105x80	13.5x11	400	80	220	201	18	300	
AD4302 PUR 150 K	150	45	65	140x110	105x80	13.5x11	400	100	220	201	18	450	
AD4302 PUR 150 S	150	45	65	140x110	105x80	13.5x11	400	120	220	201	18	700	
AD4302 PUR 200 Y	200	50	70	140x110	105x80	13.5x11	600	70	275	253	22	190	
AD4302 PUR 200 M	200	50	70	140x110	105x80	13.5x11	600	90	275	253	22	300	
AD4302 PUR 200 K	200	50	70	140x110	105x80	13.5x11	600	110	275	253	22	450	
AD4302 PUR 200 S	200	50	70	140x110	105x80	13.5x11	600	130	275	253	22	700	



PUR		POLİAMİD KASNAK ÜZERİ POLİÜRETAN KAPLAMA RULMANLI											
KOD NO								MAKSİMUM TAŞIMA KAPASİTESİ kg	ÖN GERME KUVVETİ kg	H2 TOPLAM YÜKSEKLİK mm	H1 YÜKLÜ TOPLAM YÜKSEKLİK mm	L YAY YOLU mm	YAYIN SON KUVVETİ kg
AD4302 PUR 100 F04 Y	100	35	65	247	140x110	105x80	13.5x11	200	40	177	160	17	160
AD4302 PUR 100 F04 M	100	35	65	247	140x110	105x80	13.5x11	200	70	177	160	17	300
AD4302 PUR 100 F04 K	100	35	65	247	140x110	105x80	13.5x11	200	80	177	160	17	450
AD4302 PUR 125 F04 Y	125	40	65	257	140x110	105x80	13.5x11	250	40	189.5	172.5	17	160
AD4302 PUR 125 F04 M	125	40	65	257	140x110	105x80	13.5x11	250	70	189.5	172.5	17	300
AD4302 PUR 125 F04 K	125	40	65	257	140x110	105x80	13.5x11	250	80	189.5	172.5	17	450
AD4302 PUR 150 F04 Y	150	45	65	262	140x110	105x80	13.5x11	400	50	220	201	18	160
AD4302 PUR 150 F04 M	150	45	65	262	140x110	105x80	13.5x11	400	80	220	201	18	300
AD4302 PUR 150 F04 K	150	45	65	262	140x110	105x80	13.5x11	400	100	220	201	18	450
AD4302 PUR 150 F04 S	150	45	65	262	140x110	105x80	13.5x11	400	120	220	201	18	700
AD4302 PUR 200 F04 Y	200	50	70	290	140x110	105x80	13.5x11	600	70	275	253	22	190
AD4302 PUR 200 F04 M	200	50	70	290	140x110	105x80	13.5x11	600	90	275	253	22	300
AD4302 PUR 200 F04 K	200	50	70	290	140x110	105x80	13.5x11	600	110	275	253	22	450
AD4302 PUR 200 F04 S	200	50	70	290	140x110	105x80	13.5x11	600	130	275	253	22	700







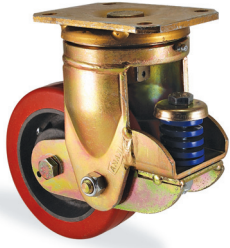

YÖN KİLİTLİ

PUR		POLİAMİD KASNAK ÜZERİ POLİÜRETAN KAPLAMA RULMANLI											
KOD NO								MAKSİMUM TAŞIMA KAPASİTESİ kg	ÖN GERME KUVVETİ kg	H2 TOPLAM YÜKSEKLİK mm	H1 YÜKLÜ TOPLAM YÜKSEKLİK mm	L YAY YOLU mm	YAYIN SON KUVVETİ kg
AD4302 PUR 100 F17 Y	100	35	65	145	140x110	105x80	13.5x11	200	40	177	160	17	160
AD4302 PUR 100 F17 M	100	35	65	145	140x110	105x80	13.5x11	200	70	177	160	17	300
AD4302 PUR 100 F17 K	100	35	65	145	140x110	105x80	13.5x11	200	80	177	160	17	450
AD4302 PUR 125 F17 Y	125	40	65	145	140x110	105x80	13.5x11	250	40	189.5	172.5	17	160
AD4302 PUR 125 F17 M	125	40	65	145	140x110	105x80	13.5x11	250	70	189.5	172.5	17	300
AD4302 PUR 125 F17 K	125	40	65	145	140x110	105x80	13.5x11	250	80	189.5	172.5	17	450
AD4302 PUR 150 F17 Y	150	45	65	145	140x110	105x80	13.5x11	400	50	220	201	18	160
AD4302 PUR 150 F17 M	150	45	65	145	140x110	105x80	13.5x11	400	80	220	201	18	300
AD4302 PUR 150 F17 K	150	45	65	145	140x110	105x80	13.5x11	400	100	220	201	18	450
AD4302 PUR 150 F17 S	150	45	65	145	140x110	105x80	13.5x11	400	120	220	201	18	700
AD4302 PUR 200 F17 Y	200	50	70	145	140x110	105x80	13.5x11	600	70	275	253	22	190
AD4302 PUR 200 F17 M	200	50	70	145	140x110	105x80	13.5x11	600	90	275	253	22	300
AD4302 PUR 200 F17 K	200	50	70	145	140x110	105x80	13.5x11	600	110	275	253	22	450
AD4302 PUR 200 F17 S	200	50	70	145	140x110	105x80	13.5x11	600	130	275	253	22	700







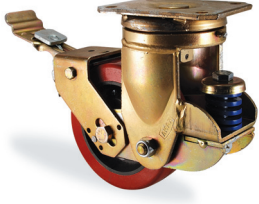

KUR

KAMALON KASNAK ÜZERİ ENJEKSİYON POLİÜRETAN KAPLAMA RULMANLI

KOD NO	 mm	 mm	 mm	 mm	 mm	 mm	MAKSİMUM TAŞIMA KAPASİTESİ kg	ÖN GERME KUVVETİ kg	H2 TOPLAM YÜKSEKLİK mm	H1 YÜKLÜ TOPLAM YÜKSEKLİK mm	L YAY YOLU mm	YAYIN SON KUVVETİ kg
AD4302 KUR 100 Y	100	40	65	140x110	105x80	13.5x11	250	40	177	160	17	160
AD4302 KUR 100 M	100	40	65	140x110	105x80	13.5x11	250	70	177	160	17	300
AD4302 KUR 100 K	100	40	65	140x110	105x80	13.5x11	250	80	177	160	17	450
AD4302 KUR 125 Y	125	50	65	140x110	105x80	13.5x11	300	40	189.5	172.5	17	160
AD4302 KUR 125 M	125	50	65	140x110	105x80	13.5x11	300	70	189.5	172.5	17	300
AD4302 KUR 125 K	125	50	65	140x110	105x80	13.5x11	300	80	189.5	172.5	17	450
AD4302 KUR 150 Y	150	50	65	140x110	105x80	13.5x11	550	50	220	201	18	160
AD4302 KUR 150 M	150	50	65	140x110	105x80	13.5x11	550	80	220	201	18	300
AD4302 KUR 150 K	150	50	65	140x110	105x80	13.5x11	550	100	220	201	18	450
AD4302 KUR 150 S	150	50	65	140x110	105x80	13.5x11	550	120	220	201	18	700
AD4302 KUR 160 Y	160	50	70	140x110	105x80	13.5x11	650	70	275	253	22	190
AD4302 KUR 160 M	160	50	70	140x110	105x80	13.5x11	650	90	275	253	22	300
AD4302 KUR 160 K	160	50	70	140x110	105x80	13.5x11	650	110	275	253	22	450
AD4302 KUR 160 S	160	50	70	140x110	105x80	13.5x11	650	130	275	253	22	700
AD4302 KUR 200 Y	200	50	70	140x110	105x80	13.5x11	800	70	275	253	22	190
AD4302 KUR 200 M	200	50	70	140x110	105x80	13.5x11	800	90	275	253	22	300
AD4302 KUR 200 K	200	50	70	140x110	105x80	13.5x11	800	110	275	253	22	450
AD4302 KUR 200 S	200	50	70	140x110	105x80	13.5x11	800	130	275	253	22	700



KUR		KAMALON KASNAK ÜZERİ ENJEKSİYON POLİÜRETAN KAPLAMA RULMANLI											
KOD NO								MAKSİMUM TAŞIMA KAPASİTESİ	ÖN GERME KUVVETİ	H2 TOPLAM YÜKSEKLİK	H1 YÜKLÜ TOPLAM YÜKSEKLİK	L YAY YOLU	YAYIN SON KUVVETİ
	mm	mm	mm	mm	mm	mm	mm	kg	kg	mm	mm	mm	kg
AD4302 KUR 100 F04 Y	100	40	65	247	140x110	105x80	13.5x11	250	40	177	160	17	160
AD4302 KUR 100 F04 M	100	40	65	247	140x110	105x80	13.5x11	250	70	177	160	17	300
AD4302 KUR 100 F04 K	100	40	65	247	140x110	105x80	13.5x11	250	80	177	160	17	450
AD4302 KUR 125 F04 Y	125	50	65	257	140x110	105x80	13.5x11	300	40	189.5	172.5	17	160
AD4302 KUR 125 F04 M	125	50	65	257	140x110	105x80	13.5x11	300	70	189.5	172.5	17	300
AD4302 KUR 125 F04 K	125	50	65	257	140x110	105x80	13.5x11	300	80	189.5	172.5	17	450
AD4302 KUR 150 F04 Y	150	50	65	262	140x110	105x80	13.5x11	550	50	220	201	18	160
AD4302 KUR 150 F04 M	150	50	65	262	140x110	105x80	13.5x11	550	80	220	201	18	300
AD4302 KUR 150 F04 K	150	50	65	262	140x110	105x80	13.5x11	550	100	220	201	18	450
AD4302 KUR 150 F04 S	150	50	65	262	140x110	105x80	13.5x11	550	120	220	201	18	700
AD4302 KUR 160 F04 Y	160	50	70	290	140x110	105x80	13.5x11	650	70	275	253	22	190
AD4302 KUR 160 F04 M	160	50	70	290	140x110	105x80	13.5x11	650	90	275	253	22	300
AD4302 KUR 160 F04 K	160	50	70	290	140x110	105x80	13.5x11	650	110	275	253	22	450
AD4302 KUR 160 F04 S	160	50	70	290	140x110	105x80	13.5x11	650	130	275	253	22	700
AD4302 KUR 200 F04 Y	200	50	70	290	140x110	105x80	13.5x11	800	70	275	253	22	190
AD4302 KUR 200 F04 M	200	50	70	290	140x110	105x80	13.5x11	800	90	275	253	22	300
AD4302 KUR 200 F04 K	200	50	70	290	140x110	105x80	13.5x11	800	110	275	253	22	450
AD4302 KUR 200 F04 S	200	50	70	290	140x110	105x80	13.5x11	800	130	275	253	22	700



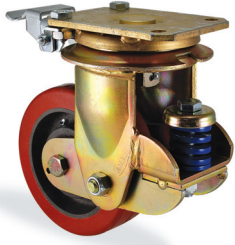



AD4302 Serisi (Amortisörlü)



YÖN KİLİTLİ

KUR





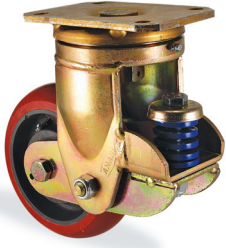

KAMALON KASNAK ÜZERİ ENJEKSİYON POLİÜRETAN KAPLAMA RULMANLI

KOD NO	 mm	 mm	 mm	 mm	 mm	 mm	 mm	MAKSİMUM TAŞIMA KAPASİTESİ kg	ÖN GERME KUVVETİ kg	H2 TOPLAM YÜKSEKLİK mm	H1 YÜKLÜ TOPLAM YÜKSEKLİK mm	L YAY YOLU mm	YAYIN SON KUVVETİ kg
AD4302 KUR 100 F17 Y	100	40	65	145	140x110	105x80	13.5x11	250	40	177	160	17	160
AD4302 KUR 100 F17 M	100	40	65	145	140x110	105x80	13.5x11	250	70	177	160	17	300
AD4302 KUR 100 F17 K	100	40	65	145	140x110	105x80	13.5x11	250	80	177	160	17	450
AD4302 KUR 125 F17 Y	125	50	65	145	140x110	105x80	13.5x11	300	40	189.5	172.5	17	160
AD4302 KUR 125 F17 M	125	50	65	145	140x110	105x80	13.5x11	300	70	189.5	172.5	17	300
AD4302 KUR 125 F17 K	125	50	65	145	140x110	105x80	13.5x11	300	80	189.5	172.5	17	450
AD4302 KUR 150 F17 Y	150	50	65	145	140x110	105x80	13.5x11	550	50	220	201	18	160
AD4302 KUR 150 F17 M	150	50	65	145	140x110	105x80	13.5x11	550	80	220	201	18	300
AD4302 KUR 150 F17 K	150	50	65	145	140x110	105x80	13.5x11	550	100	220	201	18	450
AD4302 KUR 150 F17 S	150	50	65	145	140x110	105x80	13.5x11	550	120	220	201	18	700
AD4302 KUR 160 F17 Y	160	50	70	145	140x110	105x80	13.5x11	650	70	275	253	22	190
AD4302 KUR 160 F17 M	160	50	70	145	140x110	105x80	13.5x11	650	90	275	253	22	300
AD4302 KUR 160 F17 K	160	50	70	145	140x110	105x80	13.5x11	650	110	275	253	22	450
AD4302 KUR 160 F17 S	160	50	70	145	140x110	105x80	13.5x11	650	130	275	253	22	700
AD4302 KUR 200 F17 Y	200	50	70	145	140x110	105x80	13.5x11	800	70	275	253	22	190
AD4302 KUR 200 F17 M	200	50	70	145	140x110	105x80	13.5x11	800	90	275	253	22	300
AD4302 KUR 200 F17 K	200	50	70	145	140x110	105x80	13.5x11	800	110	275	253	22	450
AD4302 KUR 200 F17 S	200	50	70	145	140x110	105x80	13.5x11	800	130	275	253	22	700



K2UR





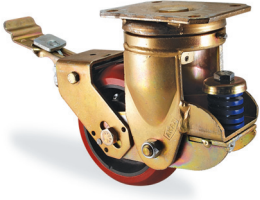

KAMALON KASNAK ÜZERİ OVAL ENJEKSİYON POLİÜRETAN KAPLAMA RULMANLI

KOD NO	 mm	 mm	 mm	 mm	 mm	 mm	MAKSİMUM TAŞIMA KAPASİTESİ kg	ÖN GERME KUVVETİ kg	H2 TOPLAM YÜKSEKLİK mm	H1 YÜKLÜ TOPLAM YÜKSEKLİK mm	L YAY YOLU mm	YAYIN SON KUVVETİ kg
AD4302 K2UR 100 Y	100	40	65	140x110	105x80	13.5x11	250	40	177	160	17	160
AD4302 K2UR 100 M	100	40	65	140x110	105x80	13.5x11	250	70	177	160	17	300
AD4302 K2UR 100 K	100	40	65	140x110	105x80	13.5x11	250	80	177	160	17	450
AD4302 K2UR 125 Y	125	50	65	140x110	105x80	13.5x11	300	40	189.5	172.5	17	160
AD4302 K2UR 125 M	125	50	65	140x110	105x80	13.5x11	300	70	189.5	172.5	17	300
AD4302 K2UR 125 K	125	50	65	140x110	105x80	13.5x11	300	80	189.5	172.5	17	450
AD4302 K2UR 150 Y	150	50	65	140x110	105x80	13.5x11	550	50	220	201	18	160
AD4302 K2UR 150 M	150	50	65	140x110	105x80	13.5x11	550	80	220	201	18	300
AD4302 K2UR 150 K	150	50	65	140x110	105x80	13.5x11	550	100	220	201	18	450
AD4302 K2UR 150 S	150	50	65	140x110	105x80	13.5x11	550	120	220	201	18	700
AD4302 K2UR 160 Y	160	50	70	140x110	105x80	13.5x11	650	70	275	253	22	190
AD4302 K2UR 160 M	160	50	70	140x110	105x80	13.5x11	650	90	275	253	22	300
AD4302 K2UR 160 K	160	50	70	140x110	105x80	13.5x11	650	110	275	253	22	450
AD4302 K2UR 160 S	160	50	70	140x110	105x80	13.5x11	650	130	275	253	22	700
AD4302 K2UR 200 Y	200	50	70	140x110	105x80	13.5x11	800	70	275	253	22	190
AD4302 K2UR 200 M	200	50	70	140x110	105x80	13.5x11	800	90	275	253	22	300
AD4302 K2UR 200 K	200	50	70	140x110	105x80	13.5x11	800	110	275	253	22	450
AD4302 K2UR 200 S	200	50	70	140x110	105x80	13.5x11	800	130	275	253	22	700



K2UR

KAMALON KASNAK ÜZERİ OVAL ENJEKSİYON POLİÜRETAN KAPLAMA RULMANLI







KOD NO	 mm	 mm	 mm	 mm	 mm	 mm	 mm	MAKSİMUM TAŞIMA KAPASİTESİ kg	ÖN GERME KUVVETİ kg	H2 TOPLAM YÜKSEKLİK mm	H1 YÜKLÜ TOPLAM YÜKSEKLİK mm	L YAY YOLU mm	YAYIN SON KUVVETİ kg
AD4302 K2UR 100 F04 Y	100	40	65	247	140x110	105x80	13.5x11	250	40	177	160	17	160
AD4302 K2UR 100 F04 M	100	40	65	247	140x110	105x80	13.5x11	250	70	177	160	17	300
AD4302 K2UR 100 F04 K	100	40	65	247	140x110	105x80	13.5x11	250	80	177	160	17	450
AD4302 K2UR 125 F04 Y	125	50	65	257	140x110	105x80	13.5x11	300	40	189.5	172.5	17	160
AD4302 K2UR 125 F04 M	125	50	65	257	140x110	105x80	13.5x11	300	70	189.5	172.5	17	300
AD4302 K2UR 125 F04 K	125	50	65	257	140x110	105x80	13.5x11	300	80	189.5	172.5	17	450
AD4302 K2UR 150 F04 Y	150	50	65	262	140x110	105x80	13.5x11	550	50	220	201	18	160
AD4302 K2UR 150 F04 M	150	50	65	262	140x110	105x80	13.5x11	550	80	220	201	18	300
AD4302 K2UR 150 F04 K	150	50	65	262	140x110	105x80	13.5x11	550	100	220	201	18	450
AD4302 K2UR 150 F04 S	150	50	65	262	140x110	105x80	13.5x11	550	120	220	201	18	700
AD4302 K2UR 160 F04 Y	160	50	70	290	140x110	105x80	13.5x11	650	70	275	253	22	190
AD4302 K2UR 160 F04 M	160	50	70	290	140x110	105x80	13.5x11	650	90	275	253	22	300
AD4302 K2UR 160 F04 K	160	50	70	290	140x110	105x80	13.5x11	650	110	275	253	22	450
AD4302 K2UR 160 F04 S	160	50	70	290	140x110	105x80	13.5x11	650	130	275	253	22	700
AD4302 K2UR 200 F04 Y	200	50	70	290	140x110	105x80	13.5x11	800	70	275	253	22	190
AD4302 K2UR 200 F04 M	200	50	70	290	140x110	105x80	13.5x11	800	90	275	253	22	300
AD4302 K2UR 200 F04 K	200	50	70	290	140x110	105x80	13.5x11	800	110	275	253	22	450
AD4302 K2UR 200 F04 S	200	50	70	290	140x110	105x80	13.5x11	800	130	275	253	22	700



YÖN KİLİTLİ

K2UR





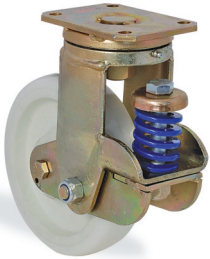

KAMALON KASNAK ÜZERİ OVAL ENJEKSİYON POLİÜRETAN KAPLAMA RULMANLI

KOD NO	 mm	 mm	 mm	 mm	 mm	 mm	 mm	MAKSİMUM TAŞIMA KAPASİTESİ kg	ÖN GERME KUVVETİ kg	H2 TOPLAM YÜKSEKLİK mm	H1 YÜKLÜ TOPLAM YÜKSEKLİK mm	L YAY YOLU mm	YAYIN SON KUVVETİ kg
AD4302 K2UR 100 F17 Y	100	40	65	145	140x110	105x80	13.5x11	250	40	177	160	17	160
AD4302 K2UR 100 F17 M	100	40	65	145	140x110	105x80	13.5x11	250	70	177	160	17	300
AD4302 K2UR 100 F17 K	100	40	65	145	140x110	105x80	13.5x11	250	80	177	160	17	450
AD4302 K2UR 125 F17 Y	125	50	65	145	140x110	105x80	13.5x11	300	40	189.5	172.5	17	160
AD4302 K2UR 125 F17 M	125	50	65	145	140x110	105x80	13.5x11	300	70	189.5	172.5	17	300
AD4302 K2UR 125 F17 K	125	50	65	145	140x110	105x80	13.5x11	300	80	189.5	172.5	17	450
AD4302 K2UR 150 F17 Y	150	50	65	145	140x110	105x80	13.5x11	550	50	220	201	18	160
AD4302 K2UR 150 F17 M	150	50	65	145	140x110	105x80	13.5x11	550	80	220	201	18	300
AD4302 K2UR 150 F17 K	150	50	65	145	140x110	105x80	13.5x11	550	100	220	201	18	450
AD4302 K2UR 150 F17 S	150	50	65	145	140x110	105x80	13.5x11	550	120	220	201	18	700
AD4302 K2UR 160 F17 Y	160	50	70	145	140x110	105x80	13.5x11	650	70	275	253	22	190
AD4302 K2UR 160 F17 M	160	50	70	145	140x110	105x80	13.5x11	650	90	275	253	22	300
AD4302 K2UR 160 F17 K	160	50	70	145	140x110	105x80	13.5x11	650	110	275	253	22	450
AD4302 K2UR 160 F17 S	160	50	70	145	140x110	105x80	13.5x11	650	130	275	253	22	700
AD4302 K2UR 200 F17 Y	200	50	70	145	140x110	105x80	13.5x11	800	70	275	253	22	190
AD4302 K2UR 200 F17 M	200	50	70	145	140x110	105x80	13.5x11	800	90	275	253	22	300
AD4302 K2UR 200 F17 K	200	50	70	145	140x110	105x80	13.5x11	800	110	275	253	22	450
AD4302 K2UR 200 F17 S	200	50	70	145	140x110	105x80	13.5x11	800	130	275	253	22	700









RPR

AĞIR TİP POLİAMİD TEKER RULMANLI

KOD NO	 mm	 mm	 mm	 mm	 mm	 mm	 mm	MAKSİMUM TAŞIMA KAPASİTESİ kg	ÖN GERME KUVVETİ kg	H2 TOPLAM YÜKSEKLİK mm	H1 YÜKLÜ TOPLAM YÜKSEKLİK mm	L YAY YOLU mm	YAYIN SON KUVVETİ kg
AD4302 RPR 100 Y	100	35	65	140x110	105x80	13.5x11	400	40	40	177	160	17	160
AD4302 RPR 100 M	100	35	65	140x110	105x80	13.5x11	400	70	70	177	160	17	300
AD4302 RPR 100 K	100	35	65	140x110	105x80	13.5x11	400	80	80	177	160	17	450
AD4302 RPR 125 Y	125	40	65	140x110	105x80	13.5x11	500	40	40	189.5	172.5	17	160
AD4302 RPR 125 M	125	40	65	140x110	105x80	13.5x11	500	70	70	189.5	172.5	17	300
AD4302 RPR 125 K	125	40	65	140x110	105x80	13.5x11	500	80	80	189.5	172.5	17	450
AD4302 RPR 150 Y	150	45	65	140x110	105x80	13.5x11	600	50	50	220	201	18	160
AD4302 RPR 150 M	150	45	65	140x110	105x80	13.5x11	600	80	80	220	201	18	300
AD4302 RPR 150 K	150	45	65	140x110	105x80	13.5x11	600	100	100	220	201	18	450
AD4302 RPR 150 S	150	45	65	140x110	105x80	13.5x11	600	120	120	220	201	18	700
AD4302 RPR 200 Y	200	50	70	140x110	105x80	13.5x11	900	70	70	275	253	22	190
AD4302 RPR 200 M	200	50	70	140x110	105x80	13.5x11	900	90	90	275	253	22	300
AD4302 RPR 200 K	200	50	70	140x110	105x80	13.5x11	900	110	110	275	253	22	450
AD4302 RPR 200 S	200	50	70	140x110	105x80	13.5x11	900	130	130	275	253	22	700





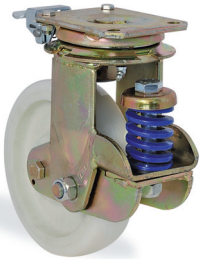

AD4302 Serisi (Amortisörlü)









RPR		AĞIR TİP POLİAMİD TEKER RULMANLI											
KOD NO								MAKSİMUM TAŞIMA KAPASİTESİ kg	ÖN GERME KUVVETİ kg	H2 TOPLAM YÜKSEKLİK mm	H1 YÜKLÜ TOPLAM YÜKSEKLİK mm	L YAY YOLU mm	YAYIN SON KUVVETİ kg
AD4302 RPR 100 F04 Y	100	35	65	247	140x110	105x80	13.5x11	400	40	177	160	17	160
AD4302 RPR 100 F04 M	100	35	65	247	140x110	105x80	13.5x11	400	70	177	160	17	300
AD4302 RPR 100 F04 K	100	35	65	247	140x110	105x80	13.5x11	400	80	177	160	17	450
AD4302 RPR 125 F04 Y	125	40	65	257	140x110	105x80	13.5x11	500	40	189.5	172.5	17	160
AD4302 RPR 125 F04 M	125	40	65	257	140x110	105x80	13.5x11	500	70	189.5	172.5	17	300
AD4302 RPR 125 F04 K	125	40	65	257	140x110	105x80	13.5x11	500	80	189.5	172.5	17	450
AD4302 RPR 150 F04 Y	150	45	65	262	140x110	105x80	13.5x11	600	50	220	201	18	160
AD4302 RPR 150 F04 M	150	45	65	262	140x110	105x80	13.5x11	600	80	220	201	18	300
AD4302 RPR 150 F04 K	150	45	65	262	140x110	105x80	13.5x11	600	100	220	201	18	450
AD4302 RPR 150 F04 S	150	45	65	262	140x110	105x80	13.5x11	600	120	220	201	18	700
AD4302 RPR 200 F04 Y	200	50	70	290	140x110	105x80	13.5x11	900	70	275	253	22	190
AD4302 RPR 200 F04 M	200	50	70	290	140x110	105x80	13.5x11	900	90	275	253	22	300
AD4302 RPR 200 F04 K	200	50	70	290	140x110	105x80	13.5x11	900	110	275	253	22	450
AD4302 RPR 200 F04 S	200	50	70	290	140x110	105x80	13.5x11	900	130	275	253	22	700









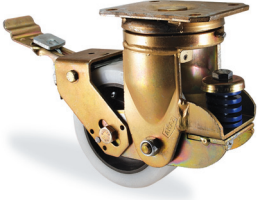

YÖN KİLİTLİ

RPR		AĞIR TİP POLİAMİD TEKER RULMANLI											
KOD NO								MAKSİMUM TAŞIMA KAPASİTESİ kg	ÖN GERME KUVVETİ kg	H2 TOPLAM YÜKSEKLİK mm	H1 YÜKLÜ TOPLAM YÜKSEKLİK mm	L YAY YOLU mm	YAYIN SON KUVVETİ kg
AD4302 RPR 100 F17 Y	100	35	65	145	140x110	105x80	13.5x11	400	40	177	160	17	160
AD4302 RPR 100 F17 M	100	35	65	145	140x110	105x80	13.5x11	400	70	177	160	17	300
AD4302 RPR 100 F17 K	100	35	65	145	140x110	105x80	13.5x11	400	80	177	160	17	450
AD4302 RPR 125 F17 Y	125	40	65	145	140x110	105x80	13.5x11	500	40	189.5	172.5	17	160
AD4302 RPR 125 F17 M	125	40	65	145	140x110	105x80	13.5x11	500	70	189.5	172.5	17	300
AD4302 RPR 125 F17 K	125	40	65	145	140x110	105x80	13.5x11	500	80	189.5	172.5	17	450
AD4302 RPR 150 F17 Y	150	45	65	145	140x110	105x80	13.5x11	600	50	220	201	18	160
AD4302 RPR 150 F17 M	150	45	65	145	140x110	105x80	13.5x11	600	80	220	201	18	300
AD4302 RPR 150 F17 K	150	45	65	145	140x110	105x80	13.5x11	600	100	220	201	18	450
AD4302 RPR 150 F17 S	150	45	65	145	140x110	105x80	13.5x11	600	120	220	201	18	700
AD4302 RPR 200 F17 Y	200	50	70	145	140x110	105x80	13.5x11	900	70	275	253	22	190
AD4302 RPR 200 F17 M	200	50	70	145	140x110	105x80	13.5x11	900	90	275	253	22	300
AD4302 RPR 200 F17 K	200	50	70	145	140x110	105x80	13.5x11	900	110	275	253	22	450
AD4302 RPR 200 F17 S	200	50	70	145	140x110	105x80	13.5x11	900	130	275	253	22	700









KPR												
KAMALON KASNAK ÜZERİ POLİAMİD KAPLAMA RULMANLI												
KOD NO	 mm	 mm	 mm	 mm	 mm	 mm	MAKSİMUM TAŞIMA KAPASİTESİ kg	ÖN GERME KUVVETİ kg	H2 TOPLAM YÜKSEKLİK mm	H1 YÜKLÜ TOPLAM YÜKSEKLİK mm	L YAY YOLU mm	YAYIN SON KUVVETİ kg
AD4302 KPR 100 Y	100	40	65	140x110	105x80	13.5x11	350	40	177	160	17	160
AD4302 KPR 100 M	100	40	65	140x110	105x80	13.5x11	350	70	177	160	17	300
AD4302 KPR 100 K	100	40	65	140x110	105x80	13.5x11	350	80	177	160	17	450
AD4302 KPR 125 Y	125	50	65	140x110	105x80	13.5x11	450	40	189.5	172.5	17	160
AD4302 KPR 125 M	125	50	65	140x110	105x80	13.5x11	450	70	189.5	172.5	17	300
AD4302 KPR 125 K	125	50	65	140x110	105x80	13.5x11	450	80	189.5	172.5	17	450
AD4302 KPR 150 Y	150	50	65	140x110	105x80	13.5x11	700	50	220	201	18	160
AD4302 KPR 150 M	150	50	65	140x110	105x80	13.5x11	700	80	220	201	18	300
AD4302 KPR 150 K	150	50	65	140x110	105x80	13.5x11	700	100	220	201	18	450
AD4302 KPR 150 S	150	50	65	140x110	105x80	13.5x11	700	120	220	201	18	700
AD4302 KPR 160 Y	160	50	70	140x110	105x80	13.5x11	800	70	275	253	22	190
AD4302 KPR 160 M	160	50	70	140x110	105x80	13.5x11	800	90	275	253	22	300
AD4302 KPR 160 K	160	50	70	140x110	105x80	13.5x11	800	110	275	253	22	450
AD4302 KPR 160 S	160	50	70	140x110	105x80	13.5x11	800	130	275	253	22	700
AD4302 KPR 200 Y	200	50	70	140x110	105x80	13.5x11	1000	70	275	253	22	190
AD4302 KPR 200 M	200	50	70	140x110	105x80	13.5x11	1000	90	275	253	22	300
AD4302 KPR 200 K	200	50	70	140x110	105x80	13.5x11	1000	110	275	253	22	450
AD4302 KPR 200 S	200	50	70	140x110	105x80	13.5x11	1000	130	275	253	22	700



KPR		KAMALON KASNAK ÜZERİ POLİAMİD KAPLAMA RULMANLI											
KOD NO	 mm	 mm	 mm	 mm	 mm	 mm	 mm	MAKSİMUM TAŞIMA KAPASİTESİ kg	ÖN GERME KUVVETİ kg	H2 TOPLAM YÜKSEKLİK mm	H1 YÜKLÜ TOPLAM YÜKSEKLİK mm	L YAY YOLU mm	YAYIN SON KUVVETİ kg
AD4302 KPR 100 F04 Y	100	40	65	247	140x110	105x80	13.5x11	350	40	177	160	17	160
AD4302 KPR 100 F04 M	100	40	65	247	140x110	105x80	13.5x11	350	70	177	160	17	300
AD4302 KPR 100 F04 K	100	40	65	247	140x110	105x80	13.5x11	350	80	177	160	17	450
AD4302 KPR 125 F04 Y	125	50	65	257	140x110	105x80	13.5x11	450	40	189.5	172.5	17	160
AD4302 KPR 125 F04 M	125	50	65	257	140x110	105x80	13.5x11	450	70	189.5	172.5	17	300
AD4302 KPR 125 F04 K	125	50	65	257	140x110	105x80	13.5x11	450	80	189.5	172.5	17	450
AD4302 KPR 150 F04 Y	150	50	65	262	140x110	105x80	13.5x11	700	50	220	201	18	160
AD4302 KPR 150 F04 M	150	50	65	262	140x110	105x80	13.5x11	700	80	220	201	18	300
AD4302 KPR 150 F04 K	150	50	65	262	140x110	105x80	13.5x11	700	100	220	201	18	450
AD4302 KPR 150 F04 S	150	50	65	262	140x110	105x80	13.5x11	700	120	220	201	18	700
AD4302 KPR 160 F04 Y	160	50	70	290	140x110	105x80	13.5x11	800	70	275	253	22	190
AD4302 KPR 160 F04 M	160	50	70	290	140x110	105x80	13.5x11	800	90	275	253	22	300
AD4302 KPR 160 F04 K	160	50	70	290	140x110	105x80	13.5x11	800	110	275	253	22	450
AD4302 KPR 160 F04 S	160	50	70	290	140x110	105x80	13.5x11	800	130	275	253	22	700
AD4302 KPR 200 F04 Y	200	50	70	290	140x110	105x80	13.5x11	1000	70	275	253	22	190
AD4302 KPR 200 F04 M	200	50	70	290	140x110	105x80	13.5x11	1000	90	275	253	22	300
AD4302 KPR 200 F04 K	200	50	70	290	140x110	105x80	13.5x11	1000	110	275	253	22	450
AD4302 KPR 200 F04 S	200	50	70	290	140x110	105x80	13.5x11	1000	130	275	253	22	700



YÖN KİLİTLİ





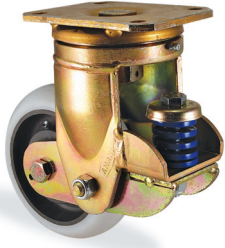

KPR		KAMALON KASNAK ÜZERİ POLİAMİD KAPLAMA RULMANLI											
KOD NO	 mm	 mm	 mm	 mm	 mm	 mm	 mm	MAKSİMUM TAŞIMA KAPASİTESİ kg	ÖN GERME KUVVETİ kg	H2 TOPLAM YÜKSEKLİK mm	H1 YÜKLÜ TOPLAM YÜKSEKLİK mm	L YAY YOLU mm	YAYIN SON KUVVETİ kg
AD4302 KPR 100 F17 Y	100	40	65	145	140x110	105x80	13.5x11	350	40	177	160	17	160
AD4302 KPR 100 F17 M	100	40	65	145	140x110	105x80	13.5x11	350	70	177	160	17	300
AD4302 KPR 100 F17 K	100	40	65	145	140x110	105x80	13.5x11	350	80	177	160	17	450
AD4302 KPR 125 F17 Y	125	50	65	145	140x110	105x80	13.5x11	450	40	189.5	172.5	17	160
AD4302 KPR 125 F17 M	125	50	65	145	140x110	105x80	13.5x11	450	70	189.5	172.5	17	300
AD4302 KPR 125 F17 K	125	50	65	145	140x110	105x80	13.5x11	450	80	189.5	172.5	17	450
AD4302 KPR 150 F17 Y	150	50	65	145	140x110	105x80	13.5x11	700	50	220	201	18	160
AD4302 KPR 150 F17 M	150	50	65	145	140x110	105x80	13.5x11	700	80	220	201	18	300
AD4302 KPR 150 F17 K	150	50	65	145	140x110	105x80	13.5x11	700	100	220	201	18	450
AD4302 KPR 150 F17 S	150	50	65	145	140x110	105x80	13.5x11	700	120	220	201	18	700
AD4302 KPR 160 F17 Y	160	50	70	145	140x110	105x80	13.5x11	800	70	275	253	22	190
AD4302 KPR 160 F17 M	160	50	70	145	140x110	105x80	13.5x11	800	90	275	253	22	300
AD4302 KPR 160 F17 K	160	50	70	145	140x110	105x80	13.5x11	800	110	275	253	22	450
AD4302 KPR 160 F17 S	160	50	70	145	140x110	105x80	13.5x11	800	130	275	253	22	700
AD4302 KPR 200 F17 Y	200	50	70	145	140x110	105x80	13.5x11	1000	70	275	253	22	190
AD4302 KPR 200 F17 M	200	50	70	145	140x110	105x80	13.5x11	1000	90	275	253	22	300
AD4302 KPR 200 F17 K	200	50	70	145	140x110	105x80	13.5x11	1000	110	275	253	22	450
AD4302 KPR 200 F17 S	200	50	70	145	140x110	105x80	13.5x11	1000	130	275	253	22	700

AD4302 Serisi (Amortisörlü)



K2PR





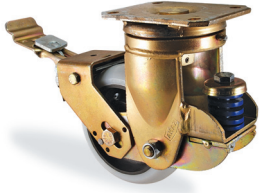

KAMALON KASNAK ÜZERİ OVAL POLİAMİD KAPLAMA RULMANLI

KOD NO	 mm	 mm	 mm	 mm	 mm	 mm	MAKSİMUM TAŞIMA KAPASİTESİ kg	ÖN GERME KUVVETİ kg	H2 TOPLAM YÜKSEKLİK mm	H1 YÜKLÜ TOPLAM YÜKSEKLİK mm	L YAY YOLU mm	YAYIN SON KUVVETİ kg
AD4302 K2PR 100 Y	100	40	65	140x110	105x80	13.5x11	350	40	177	160	17	160
AD4302 K2PR 100 M	100	40	65	140x110	105x80	13.5x11	350	70	177	160	17	300
AD4302 K2PR 100 K	100	40	65	140x110	105x80	13.5x11	350	80	177	160	17	450
AD4302 K2PR 125 Y	125	50	65	140x110	105x80	13.5x11	450	40	189.5	172.5	17	160
AD4302 K2PR 125 M	125	50	65	140x110	105x80	13.5x11	450	70	189.5	172.5	17	300
AD4302 K2PR 125 K	125	50	65	140x110	105x80	13.5x11	450	80	189.5	172.5	17	450
AD4302 K2PR 150 Y	150	50	65	140x110	105x80	13.5x11	700	50	220	201	18	160
AD4302 K2PR 150 M	150	50	65	140x110	105x80	13.5x11	700	80	220	201	18	300
AD4302 K2PR 150 K	150	50	65	140x110	105x80	13.5x11	700	100	220	201	18	450
AD4302 K2PR 150 S	150	50	65	140x110	105x80	13.5x11	700	120	220	201	18	700
AD4302 K2PR 160 Y	160	50	70	140x110	105x80	13.5x11	800	70	275	253	22	190
AD4302 K2PR 160 M	160	50	70	140x110	105x80	13.5x11	800	90	275	253	22	300
AD4302 K2PR 160 K	160	50	70	140x110	105x80	13.5x11	800	110	275	253	22	450
AD4302 K2PR 160 S	160	50	70	140x110	105x80	13.5x11	800	130	275	253	22	700
AD4302 K2PR 200 Y	200	50	70	140x110	105x80	13.5x11	1000	70	275	253	22	190
AD4302 K2PR 200 M	200	50	70	140x110	105x80	13.5x11	1000	90	275	253	22	300
AD4302 K2PR 200 K	200	50	70	140x110	105x80	13.5x11	1000	110	275	253	22	450
AD4302 K2PR 200 S	200	50	70	140x110	105x80	13.5x11	1000	130	275	253	22	700



K2PR

KAMALON KASNAK ÜZERİ OVAL POLİAMİD KAPLAMA RULMANLI

KOD NO	 mm	 mm	 mm	 mm	 mm	 mm	 mm	MAKSİMUM TAŞIMA KAPASİTESİ kg	ÖN GERME KUVVETİ kg	H2 TOPLAM YÜKSEKLİK mm	H1 YÜKLÜ TOPLAM YÜKSEKLİK mm	L YAY YOLU mm	YAYIN SON KUVVETİ kg
AD4302 K2PR 100 F04 Y	100	40	65	247	140x110	105x80	13.5x11	350	40	177	160	17	160
AD4302 K2PR 100 F04 M	100	40	65	247	140x110	105x80	13.5x11	350	70	177	160	17	300
AD4302 K2PR 100 F04 K	100	40	65	247	140x110	105x80	13.5x11	350	80	177	160	17	450
AD4302 K2PR 125 F04 Y	125	50	65	257	140x110	105x80	13.5x11	450	40	189.5	172.5	17	160
AD4302 K2PR 125 F04 M	125	50	65	257	140x110	105x80	13.5x11	450	70	189.5	172.5	17	300
AD4302 K2PR 125 F04 K	125	50	65	257	140x110	105x80	13.5x11	450	80	189.5	172.5	17	450
AD4302 K2PR 150 F04 Y	150	50	65	262	140x110	105x80	13.5x11	700	50	220	201	18	160
AD4302 K2PR 150 F04 M	150	50	65	262	140x110	105x80	13.5x11	700	80	220	201	18	300
AD4302 K2PR 150 F04 K	150	50	65	262	140x110	105x80	13.5x11	700	100	220	201	18	450
AD4302 K2PR 150 F04 S	150	50	65	262	140x110	105x80	13.5x11	700	120	220	201	18	700
AD4302 K2PR 160 F04 Y	160	50	70	290	140x110	105x80	13.5x11	800	70	275	253	22	190
AD4302 K2PR 160 F04 M	160	50	70	290	140x110	105x80	13.5x11	800	90	275	253	22	300
AD4302 K2PR 160 F04 K	160	50	70	290	140x110	105x80	13.5x11	800	110	275	253	22	450
AD4302 K2PR 160 F04 S	160	50	70	290	140x110	105x80	13.5x11	800	130	275	253	22	700
AD4302 K2PR 200 F04 Y	200	50	70	290	140x110	105x80	13.5x11	1000	70	275	253	22	190
AD4302 K2PR 200 F04 M	200	50	70	290	140x110	105x80	13.5x11	1000	90	275	253	22	300
AD4302 K2PR 200 F04 K	200	50	70	290	140x110	105x80	13.5x11	1000	110	275	253	22	450
AD4302 K2PR 200 F04 S	200	50	70	290	140x110	105x80	13.5x11	1000	130	275	253	22	700



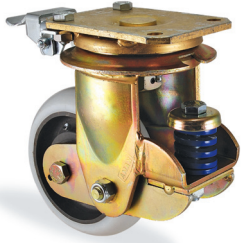



AD4302 Serisi (Amortisörlü)



YÖN KİLİTLİ

K2PR

KAMALON KASNAK ÜZERİ OVAL POLİAMİD KAPLAMA RULMANLI

KOD NO	 mm	 mm	 mm	 mm	 mm	 mm	 mm	MAKSİMUM TAŞIMA KAPASİTESİ kg	ÖN GERME KUVVETİ kg	H2 TOPLAM YÜKSEKLİK mm	H1 YÜKLÜ TOPLAM YÜKSEKLİK mm	L YAY YOLU mm	YAYIN SON KUVVETİ kg
AD4302 K2PR 100 F17 Y	100	40	65	145	140x110	105x80	13.5x11	350	40	177	160	17	160
AD4302 K2PR 100 F17 M	100	40	65	145	140x110	105x80	13.5x11	350	70	177	160	17	300
AD4302 K2PR 100 F17 K	100	40	65	145	140x110	105x80	13.5x11	350	80	177	160	17	450
AD4302 K2PR 125 F17 Y	125	50	65	145	140x110	105x80	13.5x11	450	40	189.5	172.5	17	160
AD4302 K2PR 125 F17 M	125	50	65	145	140x110	105x80	13.5x11	450	70	189.5	172.5	17	300
AD4302 K2PR 125 F17 K	125	50	65	145	140x110	105x80	13.5x11	450	80	189.5	172.5	17	450
AD4302 K2PR 150 F17 Y	150	50	65	145	140x110	105x80	13.5x11	700	50	220	201	18	160
AD4302 K2PR 150 F17 M	150	50	65	145	140x110	105x80	13.5x11	700	80	220	201	18	300
AD4302 K2PR 150 F17 K	150	50	65	145	140x110	105x80	13.5x11	700	100	220	201	18	450
AD4302 K2PR 150 F17 S	150	50	65	145	140x110	105x80	13.5x11	700	120	220	201	18	700
AD4302 K2PR 160 F17 Y	160	50	70	145	140x110	105x80	13.5x11	800	70	275	253	22	190
AD4302 K2PR 160 F17 M	160	50	70	145	140x110	105x80	13.5x11	800	90	275	253	22	300
AD4302 K2PR 160 F17 K	160	50	70	145	140x110	105x80	13.5x11	800	110	275	253	22	450
AD4302 K2PR 160 F17 S	160	50	70	145	140x110	105x80	13.5x11	800	130	275	253	22	700
AD4302 K2PR 200 F17 Y	200	50	70	145	140x110	105x80	13.5x11	1000	70	275	253	22	190
AD4302 K2PR 200 F17 M	200	50	70	145	140x110	105x80	13.5x11	1000	90	275	253	22	300
AD4302 K2PR 200 F17 K	200	50	70	145	140x110	105x80	13.5x11	1000	110	275	253	22	450
AD4302 K2PR 200 F17 S	200	50	70	145	140x110	105x80	13.5x11	1000	130	275	253	22	700

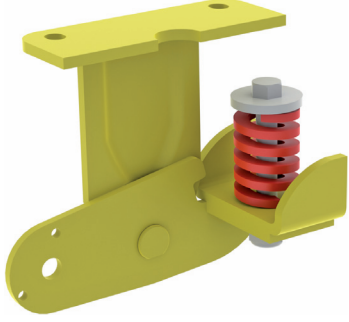

- A: SABİT TABLA
- B: MAŞA AYAĞI
- C: MAŞA AYAK KAYNAĞI
- D: HAREKETLİ MAŞA AYAĞI
- E: YAY MONTAJ CİVATASI
- F: YAY BASKI SACI
- G: AMORTİSÖR YAYI
- H: YAY KAPATMA SACI

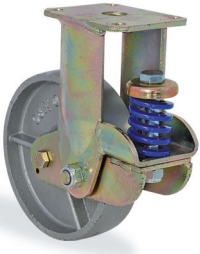
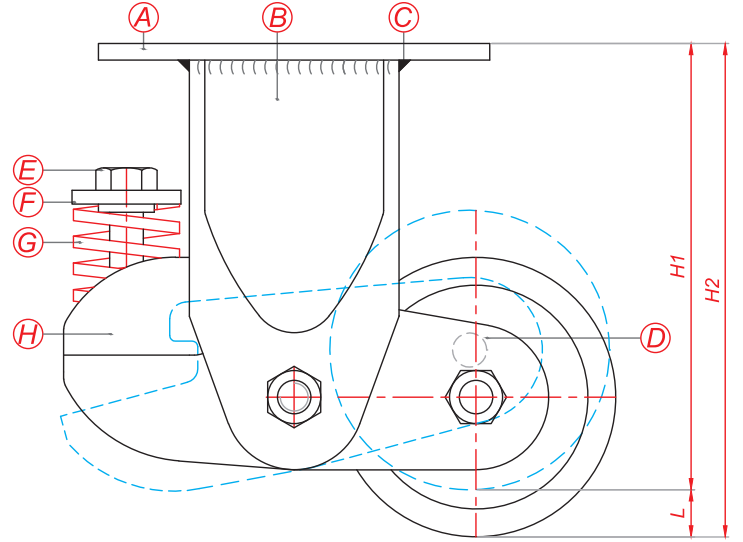

DDR

DÖKÜM TEKER RULMANLI





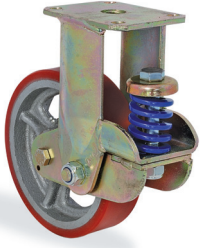

KOD NO	mm	mm	mm	mm	mm	mm	MAKSİMUM TAŞIMA KAPASİTESİ kg	ÖN GERME KUVVETİ kg	H2 TOPLAM YÜKSEKLİK mm	H1 YÜKLÜ TOPLAM YÜKSEKLİK mm	L YAY YOLU mm	YAYIN SON KUVVETİ kg
AD4307 DDR 100 Y	100	35	65	140x110	105x80	13.5x11	400	40	177	160	17	160
AD4307 DDR 100 M	100	35	65	140x110	105x80	13.5x11	400	70	177	160	17	300
AD4307 DDR 100 K	100	35	65	140x110	105x80	13.5x11	400	80	177	160	17	450
AD4307 DDR 125 Y	125	40	65	140x110	105x80	13.5x11	500	40	189.5	172.5	17	160
AD4307 DDR 125 M	125	40	65	140x110	105x80	13.5x11	500	70	189.5	172.5	17	300
AD4307 DDR 125 K	125	40	65	140x110	105x80	13.5x11	500	80	189.5	172.5	17	450
AD4307 DDR 150 Y	150	45	65	140x110	105x80	13.5x11	800	50	220	201	18	160
AD4307 DDR 150 M	150	45	65	140x110	105x80	13.5x11	800	80	220	201	18	300
AD4307 DDR 150 K	150	45	65	140x110	105x80	13.5x11	800	100	220	201	18	450
AD4307 DDR 150 S	150	45	65	140x110	105x80	13.5x11	800	120	220	201	18	700
AD4307 DDR 200 Y	200	50	70	140x110	105x80	13.5x11	1100	70	275	253	22	190
AD4307 DDR 200 M	200	50	70	140x110	105x80	13.5x11	1100	90	275	253	22	300
AD4307 DDR 200 K	200	50	70	140x110	105x80	13.5x11	1100	110	275	253	22	450
AD4307 DDR 200 S	200	50	70	140x110	105x80	13.5x11	1100	130	275	253	22	700

AD4307 Serisi (Amortisörlü)



DOR





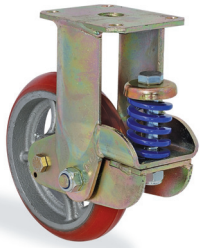

DÖKÜM KASNAK ÜZERİ DÖKME POLİÜRETAN KAPLAMA RULMANLI

KOD NO	 mm	 mm	 mm	 mm	 mm	 mm	MAKSİMUM TAŞIMA KAPASİTESİ kg	ÖN GERME KUVVETİ kg	H2 TOPLAM YÜKSEKLİK mm	H1 YÜKLÜ TOPLAM YÜKSEKLİK mm	L YAY YOLU mm	YAYIN SON KUVVETİ kg
AD4307 DOR 100 Y	100	35	65	140x110	105x80	13.5x11	350	40	177	160	17	160
AD4307 DOR 100 M	100	35	65	140x110	105x80	13.5x11	350	70	177	160	17	300
AD4307 DOR 100 K	100	35	65	140x110	105x80	13.5x11	350	80	177	160	17	450
AD4307 DOR 125 Y	125	40	65	140x110	105x80	13.5x11	450	40	189.5	172.5	17	160
AD4307 DOR 125 M	125	40	65	140x110	105x80	13.5x11	450	70	189.5	172.5	17	300
AD4307 DOR 125 K	125	40	65	140x110	105x80	13.5x11	450	80	189.5	172.5	17	450
AD4307 DOR 150 Y	150	45	65	140x110	105x80	13.5x11	700	50	220	201	18	160
AD4307 DOR 150 M	150	45	65	140x110	105x80	13.5x11	700	80	220	201	18	300
AD4307 DOR 150 K	150	45	65	140x110	105x80	13.5x11	700	100	220	201	18	450
AD4307 DOR 150 S	150	45	65	140x110	105x80	13.5x11	700	120	220	201	18	700
AD4307 DOR 200 Y	200	50	70	140x110	105x80	13.5x11	1000	70	275	253	22	190
AD4307 DOR 200 M	200	50	70	140x110	105x80	13.5x11	1000	90	275	253	22	300
AD4307 DOR 200 K	200	50	70	140x110	105x80	13.5x11	1000	110	275	253	22	450
AD4307 DOR 200 S	200	50	70	140x110	105x80	13.5x11	1000	130	275	253	22	700



D2OR







DÖKÜM KASNAK ÜZERİ OVAL DÖKME POLİÜRETAN KAPLAMA RULMANLI

KOD NO	 mm	 mm	 mm	 mm	 mm	 mm	MAKSİMUM TAŞIMA KAPASİTESİ kg	ÖN GERME KUVVETİ kg	H2 TOPLAM YÜKSEKLİK mm	H1 YÜKLÜ TOPLAM YÜKSEKLİK mm	L YAY YOLU mm	YAYIN SON KUVVETİ kg
AD4307 D2OR 100 Y	100	35	65	140x110	105x80	13.5x11	350	40	177	160	17	160
AD4307 D2OR 100 M	100	35	65	140x110	105x80	13.5x11	350	70	177	160	17	300
AD4307 D2OR 100 K	100	35	65	140x110	105x80	13.5x11	350	80	177	160	17	450
AD4307 D2OR 125 Y	125	40	65	140x110	105x80	13.5x11	450	40	189.5	172.5	17	160
AD4307 D2OR 125 M	125	40	65	140x110	105x80	13.5x11	450	70	189.5	172.5	17	300
AD4307 D2OR 125 K	125	40	65	140x110	105x80	13.5x11	450	80	189.5	172.5	17	450
AD4307 D2OR 150 Y	150	45	65	140x110	105x80	13.5x11	700	50	220	201	18	160
AD4307 D2OR 150 M	150	45	65	140x110	105x80	13.5x11	700	80	220	201	18	300
AD4307 D2OR 150 K	150	45	65	140x110	105x80	13.5x11	700	100	220	201	18	450
AD4307 D2OR 150 S	150	45	65	140x110	105x80	13.5x11	700	120	220	201	18	700
AD4307 D2OR 200 Y	200	50	70	140x110	105x80	13.5x11	1000	70	275	253	22	190
AD4307 D2OR 200 M	200	50	70	140x110	105x80	13.5x11	1000	90	275	253	22	300
AD4307 D2OR 200 K	200	50	70	140x110	105x80	13.5x11	1000	110	275	253	22	450
AD4307 D2OR 200 S	200	50	70	140x110	105x80	13.5x11	1000	130	275	253	22	700



KOR

KAMALON KASNAK ÜZERİ DÖKME POLİÜRETAN KAPLAMA RULMANLI







KOD NO	 mm	 mm	 mm	 mm	 mm	 mm	MAKSİMUM TAŞIMA KAPASİTESİ kg	ÖN GERME KUVVETİ kg	H2 TOPLAM YÜKSEKLİK mm	H1 YÜKLÜ TOPLAM YÜKSEKLİK mm	L YAY YOLU mm	YAYIN SON KUVVETİ kg
AD4307 KOR 100 Y	100	40	65	140x110	105x80	13.5x11	350	40	177	160	17	160
AD4307 KOR 100 M	100	40	65	140x110	105x80	13.5x11	350	70	177	160	17	300
AD4307 KOR 100 K	100	40	65	140x110	105x80	13.5x11	350	80	177	160	17	450
AD4307 KOR 125 Y	125	50	65	140x110	105x80	13.5x11	450	40	189.5	172.5	17	160
AD4307 KOR 125 M	125	50	65	140x110	105x80	13.5x11	450	70	189.5	172.5	17	300
AD4307 KOR 125 K	125	50	65	140x110	105x80	13.5x11	450	80	189.5	172.5	17	450
AD4307 KOR 150 Y	150	50	65	140x110	105x80	13.5x11	700	50	220	201	18	160
AD4307 KOR 150 M	150	50	65	140x110	105x80	13.5x11	700	80	220	201	18	300
AD4307 KOR 150 K	150	50	65	140x110	105x80	13.5x11	700	100	220	201	18	450
AD4307 KOR 150 S	150	50	65	140x110	105x80	13.5x11	700	120	220	201	18	700
AD4307 KOR 160 Y	160	50	70	140x110	105x80	13.5x11	800	70	275	253	22	190
AD4307 KOR 160 M	160	50	70	140x110	105x80	13.5x11	800	90	275	253	22	300
AD4307 KOR 160 K	160	50	70	140x110	105x80	13.5x11	800	110	275	253	22	450
AD4307 KOR 160 S	160	50	70	140x110	105x80	13.5x11	800	130	275	253	22	700
AD4307 KOR 200 Y	200	50	70	140x110	105x80	13.5x11	1000	70	275	253	22	190
AD4307 KOR 200 M	200	50	70	140x110	105x80	13.5x11	1000	90	275	253	22	300
AD4307 KOR 200 K	200	50	70	140x110	105x80	13.5x11	1000	110	275	253	22	450
AD4307 KOR 200 S	200	50	70	140x110	105x80	13.5x11	1000	130	275	253	22	700

AD4307 Serisi (Amortisörlü)



K2OR





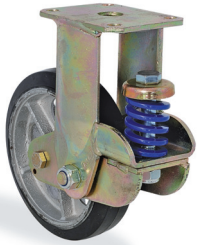

KAMALON KASNAK ÜZERİ OVAL DÖKME POLİÜRETAN KAPLAMA RULMANLI

KOD NO	 mm	 mm	 mm	 mm	 mm	 mm	MAKSİMUM TAŞIMA KAPASİTESİ kg	ÖN GERME KUVVETİ kg	H2 TOPLAM YÜKSEKLİK mm	H1 YÜKLÜ TOPLAM YÜKSEKLİK mm	L YAY YOLU mm	YAYIN SON KUVVETİ kg
AD4307 K2OR 100 Y	100	40	65	140x110	105x80	13.5x11	350	40	177	160	17	160
AD4307 K2OR 100 M	100	40	65	140x110	105x80	13.5x11	350	70	177	160	17	300
AD4307 K2OR 100 K	100	40	65	140x110	105x80	13.5x11	350	80	177	160	17	450
AD4307 K2OR 125 Y	125	50	65	140x110	105x80	13.5x11	450	40	189.5	172.5	17	160
AD4307 K2OR 125 M	125	50	65	140x110	105x80	13.5x11	450	70	189.5	172.5	17	300
AD4307 K2OR 125 K	125	50	65	140x110	105x80	13.5x11	450	80	189.5	172.5	17	450
AD4307 K2OR 150 Y	150	50	65	140x110	105x80	13.5x11	700	50	220	201	18	160
AD4307 K2OR 150 M	150	50	65	140x110	105x80	13.5x11	700	80	220	201	18	300
AD4307 K2OR 150 K	150	50	65	140x110	105x80	13.5x11	700	100	220	201	18	450
AD4307 K2OR 150 S	150	50	65	140x110	105x80	13.5x11	700	120	220	201	18	700
AD4307 K2OR 160 Y	160	50	70	140x110	105x80	13.5x11	800	70	275	253	22	190
AD4307 K2OR 160 M	160	50	70	140x110	105x80	13.5x11	800	90	275	253	22	300
AD4307 K2OR 160 K	160	50	70	140x110	105x80	13.5x11	800	110	275	253	22	450
AD4307 K2OR 160 S	160	50	70	140x110	105x80	13.5x11	800	130	275	253	22	700
AD4307 K2OR 200 Y	200	50	70	140x110	105x80	13.5x11	1000	70	275	253	22	190
AD4307 K2OR 200 M	200	50	70	140x110	105x80	13.5x11	1000	90	275	253	22	300
AD4307 K2OR 200 K	200	50	70	140x110	105x80	13.5x11	1000	110	275	253	22	450
AD4307 K2OR 200 S	200	50	70	140x110	105x80	13.5x11	1000	130	275	253	22	700









DYR

DÖKÜM KASNAK ÜZERİ VULKANİZE LASTİK KAPLAMA RULMANLI

KOD NO	 mm	 mm	 mm	 mm	 mm	 mm	MAKSİMUM TAŞIMA KAPASİTESİ kg	ÖN GERME KUVVETİ kg	H2 TOPLAM YÜKSEKLİK mm	H1 YÜKLÜ TOPLAM YÜKSEKLİK mm	L YAY YOLU mm	YAYIN SON KUVVETİ kg
AD4307 DYR 100 Y	100	35	65	140x110	105x80	13.5x11	140	40	177	160	17	160
AD4307 DYR 100 M	100	35	65	140x110	105x80	13.5x11	140	70	177	160	17	300
AD4307 DYR 100 K	100	35	65	140x110	105x80	13.5x11	140	80	177	160	17	450
AD4307 DYR 125 Y	125	40	65	140x110	105x80	13.5x11	180	40	189.5	172.5	17	160
AD4307 DYR 125 M	125	40	65	140x110	105x80	13.5x11	180	70	189.5	172.5	17	300
AD4307 DYR 125 K	125	40	65	140x110	105x80	13.5x11	180	80	189.5	172.5	17	450
AD4307 DYR 150 Y	150	45	65	140x110	105x80	13.5x11	200	50	220	201	18	160
AD4307 DYR 150 M	150	45	65	140x110	105x80	13.5x11	200	80	220	201	18	300
AD4307 DYR 150 K	150	45	65	140x110	105x80	13.5x11	200	100	220	201	18	450
AD4307 DYR 150 S	150	45	65	140x110	105x80	13.5x11	200	120	220	201	18	700
AD4307 DYR 200 Y	200	50	70	140x110	105x80	13.5x11	350	70	275	253	22	190
AD4307 DYR 200 M	200	50	70	140x110	105x80	13.5x11	350	90	275	253	22	300
AD4307 DYR 200 K	200	50	70	140x110	105x80	13.5x11	350	110	275	253	22	450
AD4307 DYR 200 S	200	50	70	140x110	105x80	13.5x11	350	130	275	253	22	700









KYR KAMALON KASNAK ÜZERİ VULKANİZE SİYAH LASTİK KAPLAMA RULMANLI												
KOD NO	 mm	 mm	 mm	 mm	 mm	 mm	MAKSİMUM TAŞIMA KAPASİTESİ kg	ÖN GERME KUVVETİ kg	H2 TOPLAM YÜKSEKLİK mm	H1 YÜKLÜ TOPLAM YÜKSEKLİK mm	L YAY YOLU mm	YAYIN SON KUVVETİ kg
AD4307 KYR 100 Y	100	40	65	140x110	105x80	13.5x11	140	40	177	160	17	160
AD4307 KYR 100 M	100	40	65	140x110	105x80	13.5x11	140	70	177	160	17	300
AD4307 KYR 100 K	100	40	65	140x110	105x80	13.5x11	140	80	177	160	17	450
AD4307 KYR 125 Y	125	40	65	140x110	105x80	13.5x11	180	40	189.5	172.5	17	160
AD4307 KYR 125 M	125	40	65	140x110	105x80	13.5x11	180	70	189.5	172.5	17	300
AD4307 KYR 125 K	125	40	65	140x110	105x80	13.5x11	180	80	189.5	172.5	17	450
AD4307 KYR 150 Y	150	45	65	140x110	105x80	13.5x11	200	50	220	201	18	160
AD4307 KYR 150 M	150	45	65	140x110	105x80	13.5x11	200	80	220	201	18	300
AD4307 KYR 150 K	150	45	65	140x110	105x80	13.5x11	200	100	220	201	18	450
AD4307 KYR 150 S	150	45	65	140x110	105x80	13.5x11	200	120	220	201	18	700
AD4307 KYR 160 Y	160	50	70	140x110	105x80	13.5x11	240	70	275	253	22	190
AD4307 KYR 160 M	160	50	70	140x110	105x80	13.5x11	240	90	275	253	22	300
AD4307 KYR 160 K	160	50	70	140x110	105x80	13.5x11	240	110	275	253	22	450
AD4307 KYR 160 S	160	50	70	140x110	105x80	13.5x11	240	130	275	253	22	700
AD4307 KYR 200 Y	200	50	70	140x110	105x80	13.5x11	350	70	275	253	22	190
AD4307 KYR 200 M	200	50	70	140x110	105x80	13.5x11	350	90	275	253	22	300
AD4307 KYR 200 K	200	50	70	140x110	105x80	13.5x11	350	110	275	253	22	450
AD4307 KYR 200 S	200	50	70	140x110	105x80	13.5x11	350	130	275	253	22	700

AD4307 Serisi (Amortisörlü)



KER





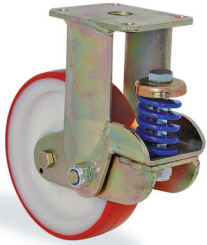

KAMALON KASNAK ÜZERİ VULKANİZE GRİ LASTİK KAPLAMA RULMANLI

KOD NO	 mm	 mm	 mm	 mm	 mm	 mm	MAKSİMUM TAŞIMA KAPASİTESİ kg	ÖN GERME KUVVETİ kg	H2 TOPLAM YÜKSEKLİK mm	H1 YÜKLÜ TOPLAM YÜKSEKLİK mm	L YAY YOLU mm	YAYIN SON KUVVETİ kg
AD4307 KER 100 Y	100	40	65	140x110	105x80	13.5x11	140	40	177	160	17	160
AD4307 KER 100 M	100	40	65	140x110	105x80	13.5x11	140	70	177	160	17	300
AD4307 KER 100 K	100	40	65	140x110	105x80	13.5x11	140	80	177	160	17	450
AD4307 KER 125 Y	125	40	65	140x110	105x80	13.5x11	180	40	189.5	172.5	17	160
AD4307 KER 125 M	125	40	65	140x110	105x80	13.5x11	180	70	189.5	172.5	17	300
AD4307 KER 125 K	125	40	65	140x110	105x80	13.5x11	180	80	189.5	172.5	17	450
AD4307 KER 150 Y	150	45	65	140x110	105x80	13.5x11	200	50	220	201	18	160
AD4307 KER 150 M	150	45	65	140x110	105x80	13.5x11	200	80	220	201	18	300
AD4307 KER 150 K	150	45	65	140x110	105x80	13.5x11	200	100	220	201	18	450
AD4307 KER 150 S	150	45	65	140x110	105x80	13.5x11	200	120	220	201	18	700
AD4307 KER 160 Y	160	50	70	140x110	105x80	13.5x11	240	70	275	253	22	190
AD4307 KER 160 M	160	50	70	140x110	105x80	13.5x11	240	90	275	253	22	300
AD4307 KER 160 K	160	50	70	140x110	105x80	13.5x11	240	110	275	253	22	450
AD4307 KER 160 S	160	50	70	140x110	105x80	13.5x11	240	130	275	253	22	700
AD4307 KER 200 Y	200	50	70	140x110	105x80	13.5x11	350	70	275	253	22	190
AD4307 KER 200 M	200	50	70	140x110	105x80	13.5x11	350	90	275	253	22	300
AD4307 KER 200 K	200	50	70	140x110	105x80	13.5x11	350	110	275	253	22	450
AD4307 KER 200 S	200	50	70	140x110	105x80	13.5x11	350	130	275	253	22	700



PUR







POLİAMİD KASNAK ÜZERİ POLİÜRETAN KAPLAMA RULMANLI

KOD NO	 mm	 mm	 mm	 mm	 mm	 mm	MAKSİMUM TAŞIMA KAPASİTESİ kg	ÖN GERME KUVVETİ kg	H2 TOPLAM YÜKSEKLİK mm	H1 YÜKLÜ TOPLAM YÜKSEKLİK mm	L YAY YOLU mm	YAYIN SON KUVVETİ kg
AD4307 PUR 100 Y	100	35	65	140x110	105x80	13.5x11	200	40	177	160	17	160
AD4307 PUR 100 M	100	35	65	140x110	105x80	13.5x11	200	70	177	160	17	300
AD4307 PUR 100 K	100	35	65	140x110	105x80	13.5x11	200	80	177	160	17	450
AD4307 PUR 125 Y	125	40	65	140x110	105x80	13.5x11	250	40	189.5	172.5	17	160
AD4307 PUR 125 M	125	40	65	140x110	105x80	13.5x11	250	70	189.5	172.5	17	300
AD4307 PUR 125 K	125	40	65	140x110	105x80	13.5x11	250	80	189.5	172.5	17	450
AD4307 PUR 150 Y	150	45	65	140x110	105x80	13.5x11	400	50	220	201	18	160
AD4307 PUR 150 M	150	45	65	140x110	105x80	13.5x11	400	80	220	201	18	300
AD4307 PUR 150 K	150	45	65	140x110	105x80	13.5x11	400	100	220	201	18	450
AD4307 PUR 150 S	150	45	65	140x110	105x80	13.5x11	400	120	220	201	18	700
AD4307 PUR 200 Y	200	50	70	140x110	105x80	13.5x11	600	70	275	253	22	190
AD4307 PUR 200 M	200	50	70	140x110	105x80	13.5x11	600	90	275	253	22	300
AD4307 PUR 200 K	200	50	70	140x110	105x80	13.5x11	600	110	275	253	22	450
AD4307 PUR 200 S	200	50	70	140x110	105x80	13.5x11	600	130	275	253	22	700



KUR

KAMALON KASNAK ÜZERİ ENJEKSİYON POLİÜRETAN KAPLAMA RULMANLI





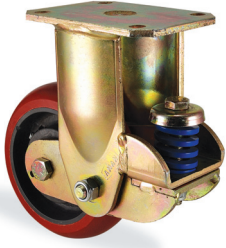

KOD NO	 mm	 mm	 mm	 mm	 mm	 mm	MAKSİMUM TAŞIMA KAPASİTESİ kg	ÖN GERME KUVVETİ kg	H2 TOPLAM YÜKSEKLİK mm	H1 YÜKLÜ TOPLAM YÜKSEKLİK mm	L YAY YOLU mm	YAYIN SON KUVVETİ kg
AD4307 KUR 100 Y	100	40	65	140x110	105x80	13.5x11	250	40	177	160	17	160
AD4307 KUR 100 M	100	40	65	140x110	105x80	13.5x11	250	70	177	160	17	300
AD4307 KUR 100 K	100	40	65	140x110	105x80	13.5x11	250	80	177	160	17	450
AD4307 KUR 125 Y	125	50	65	140x110	105x80	13.5x11	300	40	189.5	172.5	17	160
AD4307 KUR 125 M	125	50	65	140x110	105x80	13.5x11	300	70	189.5	172.5	17	300
AD4307 KUR 125 K	125	50	65	140x110	105x80	13.5x11	300	80	189.5	172.5	17	450
AD4307 KUR 150 Y	150	50	65	140x110	105x80	13.5x11	550	50	220	201	18	160
AD4307 KUR 150 M	150	50	65	140x110	105x80	13.5x11	550	80	220	201	18	300
AD4307 KUR 150 K	150	50	65	140x110	105x80	13.5x11	550	100	220	201	18	450
AD4307 KUR 150 S	150	50	65	140x110	105x80	13.5x11	550	120	220	201	18	700
AD4307 KUR 160 Y	160	50	70	140x110	105x80	13.5x11	650	70	275	253	22	190
AD4307 KUR 160 M	160	50	70	140x110	105x80	13.5x11	650	90	275	253	22	300
AD4307 KUR 160 K	160	50	70	140x110	105x80	13.5x11	650	110	275	253	22	450
AD4307 KUR 160 S	160	50	70	140x110	105x80	13.5x11	650	130	275	253	22	700
AD4307 KUR 200 Y	200	50	70	140x110	105x80	13.5x11	800	70	275	253	22	190
AD4307 KUR 200 M	200	50	70	140x110	105x80	13.5x11	800	90	275	253	22	300
AD4307 KUR 200 K	200	50	70	140x110	105x80	13.5x11	800	110	275	253	22	450
AD4307 KUR 200 S	200	50	70	140x110	105x80	13.5x11	800	130	275	253	22	700

AD4307 Serisi (Amortisörlü)



K2UR





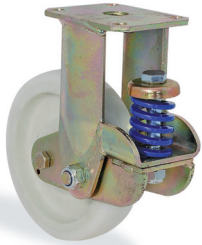

KAMALON KASNAK ÜZERİ OVAL ENJEKSİYON POLİÜRETAN KAPLAMA RULMANLI

KOD NO	 mm	 mm	 mm	 mm	 mm	 mm	MAKSİMUM TAŞIMA KAPASİTESİ kg	ÖN GERME KUVVETİ kg	H2 TOPLAM YÜKSEKLİK mm	H1 YÜKLÜ TOPLAM YÜKSEKLİK mm	L YAY YOLU mm	YAYIN SON KUVVETİ kg
AD4307 K2UR 100 Y	100	40	65	140x110	105x80	13.5x11	250	40	177	160	17	160
AD4307 K2UR 100 M	100	40	65	140x110	105x80	13.5x11	250	70	177	160	17	300
AD4307 K2UR 100 K	100	40	65	140x110	105x80	13.5x11	250	80	177	160	17	450
AD4307 K2UR 125 Y	125	50	65	140x110	105x80	13.5x11	300	40	189.5	172.5	17	160
AD4307 K2UR 125 M	125	50	65	140x110	105x80	13.5x11	300	70	189.5	172.5	17	300
AD4307 K2UR 125 K	125	50	65	140x110	105x80	13.5x11	300	80	189.5	172.5	17	450
AD4307 K2UR 150 Y	150	50	65	140x110	105x80	13.5x11	550	50	220	201	18	160
AD4307 K2UR 150 M	150	50	65	140x110	105x80	13.5x11	550	80	220	201	18	300
AD4307 K2UR 150 K	150	50	65	140x110	105x80	13.5x11	550	100	220	201	18	450
AD4307 K2UR 150 S	150	50	65	140x110	105x80	13.5x11	550	120	220	201	18	700
AD4307 K2UR 160 Y	160	50	70	140x110	105x80	13.5x11	650	70	275	253	22	190
AD4307 K2UR 160 M	160	50	70	140x110	105x80	13.5x11	650	90	275	253	22	300
AD4307 K2UR 160 K	160	50	70	140x110	105x80	13.5x11	650	110	275	253	22	450
AD4307 K2UR 160 S	160	50	70	140x110	105x80	13.5x11	650	130	275	253	22	700
AD4307 K2UR 200 Y	200	50	70	140x110	105x80	13.5x11	800	70	275	253	22	190
AD4307 K2UR 200 M	200	50	70	140x110	105x80	13.5x11	800	90	275	253	22	300
AD4307 K2UR 200 K	200	50	70	140x110	105x80	13.5x11	800	110	275	253	22	450
AD4307 K2UR 200 S	200	50	70	140x110	105x80	13.5x11	800	130	275	253	22	700









RPR

AĞIR TİP POLİAMİD TEKER RULMANLI

KOD NO	 mm	 mm	 mm	 mm	 mm	 mm	MAKSİMUM TAŞIMA KAPASİTESİ kg	ÖN GERME KUVVETİ kg	H2 TOPLAM YÜKSEKLİK mm	H1 YÜKLÜ TOPLAM YÜKSEKLİK mm	L YAY YOLU mm	YAYIN SON KUVVETİ kg
AD4307 RPR 100 Y	100	35	65	140x110	105x80	13.5x11	400	40	177	160	17	160
AD4307 RPR 100 M	100	35	65	140x110	105x80	13.5x11	400	70	177	160	17	300
AD4307 RPR 100 K	100	35	65	140x110	105x80	13.5x11	400	80	177	160	17	450
AD4307 RPR 125 Y	125	40	65	140x110	105x80	13.5x11	500	40	189.5	172.5	17	160
AD4307 RPR 125 M	125	40	65	140x110	105x80	13.5x11	500	70	189.5	172.5	17	300
AD4307 RPR 125 K	125	40	65	140x110	105x80	13.5x11	500	80	189.5	172.5	17	450
AD4307 RPR 150 Y	150	45	65	140x110	105x80	13.5x11	600	50	220	201	18	160
AD4307 RPR 150 M	150	45	65	140x110	105x80	13.5x11	600	80	220	201	18	300
AD4307 RPR 150 K	150	45	65	140x110	105x80	13.5x11	600	100	220	201	18	450
AD4307 RPR 150 S	150	45	65	140x110	105x80	13.5x11	600	120	220	201	18	700
AD4307 RPR 200 Y	200	50	70	140x110	105x80	13.5x11	900	70	275	253	22	190
AD4307 RPR 200 M	200	50	70	140x110	105x80	13.5x11	900	90	275	253	22	300
AD4307 RPR 200 K	200	50	70	140x110	105x80	13.5x11	900	110	275	253	22	450
AD4307 RPR 200 S	200	50	70	140x110	105x80	13.5x11	900	130	275	253	22	700





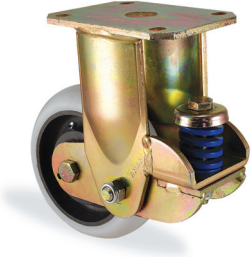



KPR												
KAMALON KASNAK ÜZERİ POLİAMİD KAPLAMA RULMANLI												
KOD NO	 mm	 mm	 mm	 mm	 mm	 mm	MAKSİMUM TAŞIMA KAPASİTESİ kg	ÖN GERME KUVVETİ kg	H2 TOPLAM YÜKSEKLİK mm	H1 YÜKLÜ TOPLAM YÜKSEKLİK mm	L YAY YOLU mm	YAYIN SON KUVVETİ kg
AD4307 KPR 100 Y	100	40	65	140x110	105x80	13.5x11	350	40	177	160	17	160
AD4307 KPR 100 M	100	40	65	140x110	105x80	13.5x11	350	70	177	160	17	300
AD4307 KPR 100 K	100	40	65	140x110	105x80	13.5x11	350	80	177	160	17	450
AD4307 KPR 125 Y	125	50	65	140x110	105x80	13.5x11	450	40	189.5	172.5	17	160
AD4307 KPR 125 M	125	50	65	140x110	105x80	13.5x11	450	70	189.5	172.5	17	300
AD4307 KPR 125 K	125	50	65	140x110	105x80	13.5x11	450	80	189.5	172.5	17	450
AD4307 KPR 150 Y	150	50	65	140x110	105x80	13.5x11	700	50	220	201	18	160
AD4307 KPR 150 M	150	50	65	140x110	105x80	13.5x11	700	80	220	201	18	300
AD4307 KPR 150 K	150	50	65	140x110	105x80	13.5x11	700	100	220	201	18	450
AD4307 KPR 150 S	150	50	65	140x110	105x80	13.5x11	700	120	220	201	18	700
AD4307 KPR 160 Y	160	50	70	140x110	105x80	13.5x11	800	70	275	253	22	190
AD4307 KPR 160 M	160	50	70	140x110	105x80	13.5x11	800	90	275	253	22	300
AD4307 KPR 160 K	160	50	70	140x110	105x80	13.5x11	800	110	275	253	22	450
AD4307 KPR 160 S	160	50	70	140x110	105x80	13.5x11	800	130	275	253	22	700
AD4307 KPR 200 Y	200	50	70	140x110	105x80	13.5x11	1000	70	275	253	22	190
AD4307 KPR 200 M	200	50	70	140x110	105x80	13.5x11	1000	90	275	253	22	300
AD4307 KPR 200 K	200	50	70	140x110	105x80	13.5x11	1000	110	275	253	22	450
AD4307 KPR 200 S	200	50	70	140x110	105x80	13.5x11	1000	130	275	253	22	700



K2PR

KAMALON KASNAK ÜZERİ OVAL POLİAMİD KAPLAMA RULMANLI

KOD NO	 mm	 mm	 mm	 mm	 mm	 mm	MAKSİMUM TAŞIMA KAPASİTESİ kg	ÖN GERME KUVVETİ kg	H2 TOPLAM YÜKSEKLİK mm	H1 YÜKLÜ TOPLAM YÜKSEKLİK mm	L YAY YOLU mm	YAYIN SON KUVVETİ kg
AD4307 K2PR 100 Y	100	40	65	140x110	105x80	13.5x11	350	40	177	160	17	160
AD4307 K2PR 100 M	100	40	65	140x110	105x80	13.5x11	350	70	177	160	17	300
AD4307 K2PR 100 K	100	40	65	140x110	105x80	13.5x11	350	80	177	160	17	450
AD4307 K2PR 125 Y	125	50	65	140x110	105x80	13.5x11	450	40	189.5	172.5	17	160
AD4307 K2PR 125 M	125	50	65	140x110	105x80	13.5x11	450	70	189.5	172.5	17	300
AD4307 K2PR 125 K	125	50	65	140x110	105x80	13.5x11	450	80	189.5	172.5	17	450
AD4307 K2PR 150 Y	150	50	65	140x110	105x80	13.5x11	700	50	220	201	18	160
AD4307 K2PR 150 M	150	50	65	140x110	105x80	13.5x11	700	80	220	201	18	300
AD4307 K2PR 150 K	150	50	65	140x110	105x80	13.5x11	700	100	220	201	18	450
AD4307 K2PR 150 S	150	50	65	140x110	105x80	13.5x11	700	120	220	201	18	700
AD4307 K2PR 160 Y	160	50	70	140x110	105x80	13.5x11	800	70	275	253	22	190
AD4307 K2PR 160 M	160	50	70	140x110	105x80	13.5x11	800	90	275	253	22	300
AD4307 K2PR 160 K	160	50	70	140x110	105x80	13.5x11	800	110	275	253	22	450
AD4307 K2PR 160 S	160	50	70	140x110	105x80	13.5x11	800	130	275	253	22	700
AD4307 K2PR 200 Y	200	50	70	140x110	105x80	13.5x11	1000	70	275	253	22	190
AD4307 K2PR 200 M	200	50	70	140x110	105x80	13.5x11	1000	90	275	253	22	300
AD4307 K2PR 200 K	200	50	70	140x110	105x80	13.5x11	1000	110	275	253	22	450
AD4307 K2PR 200 S	200	50	70	140x110	105x80	13.5x11	1000	130	275	253	22	700

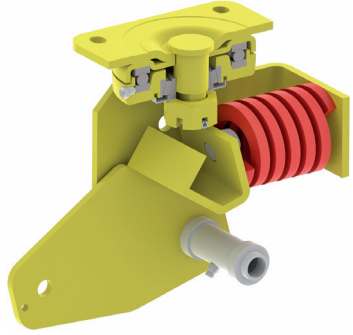

- A:** OYNAK TABLA
- B:** ÜST BİLYA KAPAĞI
- C:** BÜTE RULMAN
- D:** DÖVME ÜST BİLYA ÇANAĞI
- E:** TABLA CİVATASI
- F:** KONİK RULMAN
- G:** GRESÖRLÜK
- H:** MAŞA AYAK KAYNAĞI
- I:** METAL MUHAFAZA TOZLUK
- J:** AYARLANABİLİR TAÇLI SOMUN
- K:** YARIKLI PİM
- L:** YAY DESTEK PARÇASI
- M:** MAŞA AYAĞI
- N:** HAREKETLİ MAŞA AYAĞI
- O:** YAY DESTEK PARÇASI
- P:** YAY TOPUZU
- R:** AMORTİSÖR YAYI

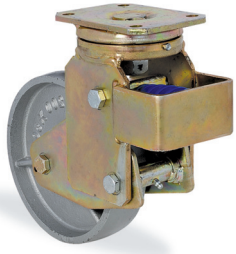
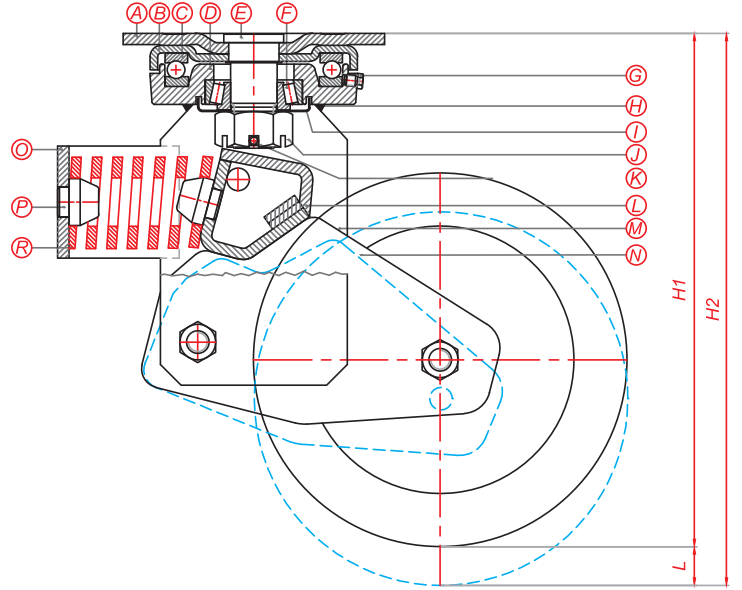

DDR

DÖKÜM TEKER RULMANLI

KOD NO	mm	mm	mm	mm	mm	mm	MAKSİMUM TAŞIMA KAPASİTESİ kg	ÖN GERME KUVVETİ kg	H2 TOPLAM YÜKSEKLİK mm	H1 YÜKLÜ TOPLAM YÜKSEKLİK mm	L YAY YOLU mm	YAYIN SON KUVVETİ kg
AY4302 DDR 200 Y	200	50	100	140x110	105x80	13.5x11	1100	30	275	223	52	200
AY4302 DDR 200 M	200	50	100	140x110	105x80	13.5x11	1100	40	275	230	45	300
AY4302 DDR 200 K	200	50	100	140x110	105x80	13.5x11	1100	60	275	237	38	450
AY4302 DDR 200 S	200	50	100	140x110	105x80	13.5x11	1100	70	275	245	30	600
AY4302 DDR 250 Y	250	50	120	140x110	105x80	13.5x11	1300	40	320	265	45	300
AY4302 DDR 250 M	250	50	120	140x110	105x80	13.5x11	1300	60	320	273	47	450
AY4302 DDR 250 K	250	50	120	140x110	105x80	13.5x11	1300	100	320	280	40	750
AY4302 DDR 250 S	250	50	120	140x110	105x80	13.5x11	1300	120	320	287	33	1000

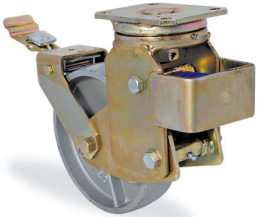

DDR

DÖKÜM TEKER RULMANLI

KOD NO	mm	mm	mm	mm	mm	mm	MAKSİMUM TAŞIMA KAPASİTESİ kg	ÖN GERME KUVVETİ kg	H2 TOPLAM YÜKSEKLİK mm	H1 YÜKLÜ TOPLAM YÜKSEKLİK mm	L YAY YOLU mm	YAYIN SON KUVVETİ kg	
AY4302 DDR 200 F04 Y	200	50	100	297	140x110	105x80	13.5x11	1100	30	275	223	52	200
AY4302 DDR 200 F04 M	200	50	100	297	140x110	105x80	13.5x11	1100	40	275	230	45	300
AY4302 DDR 200 F04 K	200	50	100	297	140x110	105x80	13.5x11	1100	60	275	237	38	450
AY4302 DDR 200 F04 S	200	50	100	297	140x110	105x80	13.5x11	1100	70	275	245	30	600
AY4302 DDR 250 F04 Y	250	50	120	390	140x110	105x80	13.5x11	1300	40	320	265	45	300
AY4302 DDR 250 F04 M	250	50	120	390	140x110	105x80	13.5x11	1300	60	320	273	47	450
AY4302 DDR 250 F04 K	250	50	120	390	140x110	105x80	13.5x11	1300	100	320	280	40	750
AY4302 DDR 250 F04 S	250	50	120	390	140x110	105x80	13.5x11	1300	120	320	287	33	1000



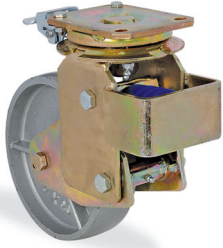



AY4302 Serisi (Amortisörlü)



YÖN KİLİTLİ

DDR





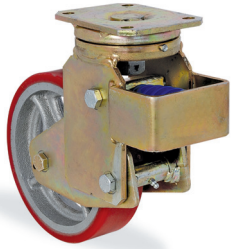

DÖKÜM TEKER RULMANLI

KOD NO								MAKSİMUM TAŞIMA KAPASİTESİ kg	ÖN GERME KUVVETİ kg	H2 TOPLAM YÜKSEKLİK mm	H1 YÜKLÜ TOPLAM YÜKSEKLİK mm	L YAY YOLU mm	YAYIN SON KUVVETİ kg
AY4302 DDR 200 F17 Y	200	50	100	145	140x110	105x80	13.5x11	1100	30	275	223	52	200
AY4302 DDR 200 F17 M	200	50	100	145	140x110	105x80	13.5x11	1100	40	275	230	45	300
AY4302 DDR 200 F17 K	200	50	100	145	140x110	105x80	13.5x11	1100	60	275	237	38	450
AY4302 DDR 200 F17 S	200	50	100	145	140x110	105x80	13.5x11	1100	70	275	245	30	600
AY4302 DDR 250 F17 Y	250	50	120	145	140x110	105x80	13.5x11	1300	40	320	265	45	300
AY4302 DDR 250 F17 M	250	50	120	145	140x110	105x80	13.5x11	1300	60	320	273	47	450
AY4302 DDR 250 F17 K	250	50	120	145	140x110	105x80	13.5x11	1300	100	320	280	40	750
AY4302 DDR 250 F17 S	250	50	120	145	140x110	105x80	13.5x11	1300	120	320	287	33	1000



DOR





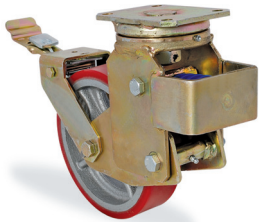

DÖKÜM KASNAK ÜZERİ DÖKME POLİÜRETAN KAPLAMA RULMANLI

KOD NO								MAKSİMUM TAŞIMA KAPASİTESİ kg	ÖN GERME KUVVETİ kg	H2 TOPLAM YÜKSEKLİK mm	H1 YÜKLÜ TOPLAM YÜKSEKLİK mm	L YAY YOLU mm	YAYIN SON KUVVETİ kg
AY4302 DOR 200 Y	200	50	100	140x110	105x80	13.5x11	1000	30	275	223	52	200	
AY4302 DOR 200 M	200	50	100	140x110	105x80	13.5x11	1000	40	275	230	45	300	
AY4302 DOR 200 K	200	50	100	140x110	105x80	13.5x11	1000	60	275	237	38	450	
AY4302 DOR 200 S	200	50	100	140x110	105x80	13.5x11	1000	70	275	245	30	600	



DOR

DÖKÜM KASNAK ÜZERİ DÖKME POLİÜRETAN KAPLAMA RULMANLI



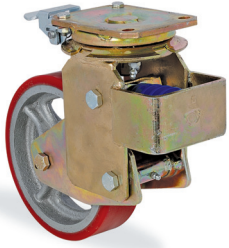



KOD NO								MAKSİMUM TAŞIMA KAPASİTESİ kg	ÖN GERME KUVVETİ kg	H2 TOPLAM YÜKSEKLİK mm	H1 YÜKLÜ TOPLAM YÜKSEKLİK mm	L YAY YOLU mm	YAYIN SON KUVVETİ kg
AY4302 DOR 200 F04 Y	200	50	100	297	140x110	105x80	13.5x11	1000	30	275	223	52	200
AY4302 DOR 200 F04 M	200	50	100	297	140x110	105x80	13.5x11	1000	40	275	230	45	300
AY4302 DOR 200 F04 K	200	50	100	297	140x110	105x80	13.5x11	1000	60	275	237	38	450
AY4302 DOR 200 F04 S	200	50	100	297	140x110	105x80	13.5x11	1000	70	275	245	30	600



YÖN KİLİTLİ

DOR





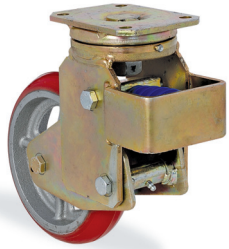

DÖKÜM KASNAK ÜZERİ DÖKME POLİÜRETAN KAPLAMA RULMANLI

KOD NO	 mm	 mm	 mm	 mm	 mm	 mm	 mm	MAKSİMUM TAŞIMA KAPASİTESİ kg	ÖN GERME KUVVETİ kg	H2 TOPLAM YÜKSEKLİK mm	H1 YÜKLÜ TOPLAM YÜKSEKLİK mm	L YAY YOLU mm	YAYIN SON KUVVETİ kg
AY4302 DOR 200 F17 Y	200	50	100	145	140x110	105x80	13.5x11	1000	30	275	223	52	200
AY4302 DOR 200 F17 M	200	50	100	145	140x110	105x80	13.5x11	1000	40	275	230	45	300
AY4302 DOR 200 F17 K	200	50	100	145	140x110	105x80	13.5x11	1000	60	275	237	38	450
AY4302 DOR 200 F17 S	200	50	100	145	140x110	105x80	13.5x11	1000	70	275	245	30	600



D2OR





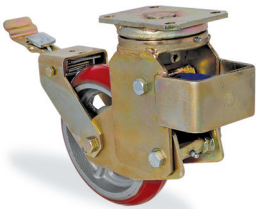

DÖKÜM KASNAK ÜZERİ OVAL DÖKME POLİÜRETAN KAPLAMA RULMANLI

KOD NO	 mm	 mm	 mm	 mm	 mm	 mm	 mm	MAKSİMUM TAŞIMA KAPASİTESİ kg	ÖN GERME KUVVETİ kg	H2 TOPLAM YÜKSEKLİK mm	H1 YÜKLÜ TOPLAM YÜKSEKLİK mm	L YAY YOLU mm	YAYIN SON KUVVETİ kg
AY4302 D2OR 200 Y	200	50	100	140x110	105x80	13.5x11	1000	30	275	223	52	200	
AY4302 D2OR 200 M	200	50	100	140x110	105x80	13.5x11	1000	40	275	230	45	300	
AY4302 D2OR 200 K	200	50	100	140x110	105x80	13.5x11	1000	60	275	237	38	450	
AY4302 D2OR 200 S	200	50	100	140x110	105x80	13.5x11	1000	70	275	245	30	600	
AY4302 D2OR 250 Y	250	50	120	140x110	105x80	13.5x11	1350	40	320	265	45	300	
AY4302 D2OR 250 M	250	50	120	140x110	105x80	13.5x11	1350	60	320	273	47	450	
AY4302 D2OR 250 K	250	50	120	140x110	105x80	13.5x11	1350	100	320	280	40	750	
AY4302 D2OR 250 S	250	50	120	140x110	105x80	13.5x11	1350	120	320	287	33	1000	



D2OR

DÖKÜM KASNAK ÜZERİ OVAL DÖKME POLİÜRETAN KAPLAMA RULMANLI

KOD NO	 mm	 mm	 mm	 mm	 mm	 mm	 mm	MAKSİMUM TAŞIMA KAPASİTESİ kg	ÖN GERME KUVVETİ kg	H2 TOPLAM YÜKSEKLİK mm	H1 YÜKLÜ TOPLAM YÜKSEKLİK mm	L YAY YOLU mm	YAYIN SON KUVVETİ kg
AY4302 D2OR 200 F04 Y	200	50	100	297	140x110	105x80	13.5x11	1000	30	275	223	52	200
AY4302 D2OR 200 F04 M	200	50	100	297	140x110	105x80	13.5x11	1000	40	275	230	45	300
AY4302 D2OR 200 F04 K	200	50	100	297	140x110	105x80	13.5x11	1000	60	275	237	38	450
AY4302 D2OR 200 F04 S	200	50	100	297	140x110	105x80	13.5x11	1000	70	275	245	30	600
AY4302 D2OR 250 F04 Y	250	50	120	390	140x110	105x80	13.5x11	1350	40	320	265	45	300
AY4302 D2OR 250 F04 M	250	50	120	390	140x110	105x80	13.5x11	1350	60	320	273	47	450
AY4302 D2OR 250 F04 K	250	50	120	390	140x110	105x80	13.5x11	1350	100	320	280	40	750
AY4302 D2OR 250 F04 S	250	50	120	390	140x110	105x80	13.5x11	1350	120	320	287	33	1000



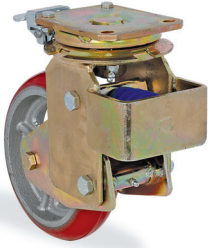



AY4302 Serisi (Amortisörlü)



YÖN KİLİTLİ

D2OR





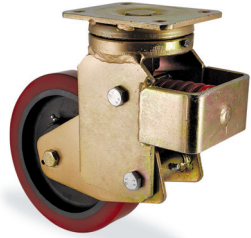

DÖKÜM KASNAK ÜZERİ OVAL DÖKME POLİÜRETAN KAPLAMA RULMANLI

KOD NO								MAKSİMUM TAŞIMA KAPASİTESİ kg	ÖN GERME KUVVETİ kg	H2 TOPLAM YÜKSEKLİK mm	H1 YÜKLÜ TOPLAM YÜKSEKLİK mm	L YAY YOLU mm	YAYIN SON KUVVETİ kg
AY4302 D2OR 200 F17 Y	200	50	100	145	140x110	105x80	13.5x11	1000	30	275	223	52	200
AY4302 D2OR 200 F17 M	200	50	100	145	140x110	105x80	13.5x11	1000	40	275	230	45	300
AY4302 D2OR 200 F17 K	200	50	100	145	140x110	105x80	13.5x11	1000	60	275	237	38	450
AY4302 D2OR 200 F17 S	200	50	100	145	140x110	105x80	13.5x11	1000	70	275	245	30	600
AY4302 D2OR 250 F17 Y	250	50	120	145	140x110	105x80	13.5x11	1350	40	320	265	45	300
AY4302 D2OR 250 F17 M	250	50	120	145	140x110	105x80	13.5x11	1350	60	320	273	47	450
AY4302 D2OR 250 F17 K	250	50	120	145	140x110	105x80	13.5x11	1350	100	320	280	40	750
AY4302 D2OR 250 F17 S	250	50	120	145	140x110	105x80	13.5x11	1350	120	320	287	33	1000



KOR





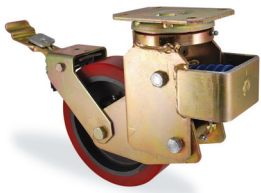

KAMALON KASNAK ÜZERİ DÖKME POLİÜRETAN KAPLAMA RULMANLI

KOD NO								MAKSİMUM TAŞIMA KAPASİTESİ kg	ÖN GERME KUVVETİ kg	H2 TOPLAM YÜKSEKLİK mm	H1 YÜKLÜ TOPLAM YÜKSEKLİK mm	L YAY YOLU mm	YAYIN SON KUVVETİ kg
AY4302 KOR 160 Y	160	50	100	140x110	105x80	13.5x11	800	30	255	203	52	200	
AY4302 KOR 160 M	160	50	100	140x110	105x80	13.5x11	800	40	255	205	45	300	
AY4302 KOR 160 K	160	50	100	140x110	105x80	13.5x11	800	60	255	217	38	450	
AY4302 KOR 160 S	160	50	100	140x110	105x80	13.5x11	800	70	255	225	30	600	
AY4302 KOR 200 Y	200	50	100	140x110	105x80	13.5x11	1000	30	275	223	52	200	
AY4302 KOR 200 M	200	50	100	140x110	105x80	13.5x11	1000	40	275	230	45	300	
AY4302 KOR 200 K	200	50	100	140x110	105x80	13.5x11	1000	60	275	237	38	450	
AY4302 KOR 200 S	200	50	100	140x110	105x80	13.5x11	1000	70	275	245	30	600	
AY4302 KOR 250 Y	250	50	120	140x110	105x80	13.5x11	1200	40	320	265	45	300	
AY4302 KOR 250 M	250	50	120	140x110	105x80	13.5x11	1200	60	320	273	47	450	
AY4302 KOR 250 K	250	50	120	140x110	105x80	13.5x11	1200	100	320	280	40	750	
AY4302 KOR 250 S	250	50	120	140x110	105x80	13.5x11	1200	120	320	287	33	1000	



KOR

KAMALON KASNAK ÜZERİ DÖKME POLİÜRETAN KAPLAMA RULMANLI



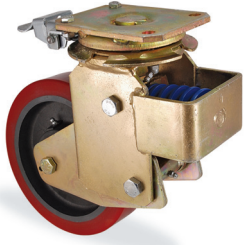

KOD NO								MAKSİMUM TAŞIMA KAPASİTESİ kg	ÖN GERME KUVVETİ kg	H2 TOPLAM YÜKSEKLİK mm	H1 YÜKLÜ TOPLAM YÜKSEKLİK mm	L YAY YOLU mm	YAYIN SON KUVVETİ kg
AY4302 KOR 160 F04 Y	160	50	100	288.5	140x110	105x80	13.5x11	800	30	255	203	52	200
AY4302 KOR 160 F04 M	160	50	100	288.5	140x110	105x80	13.5x11	800	40	255	205	45	300
AY4302 KOR 160 F04 K	160	50	100	288.5	140x110	105x80	13.5x11	800	60	255	217	38	450
AY4302 KOR 160 F04 S	160	50	100	288.5	140x110	105x80	13.5x11	800	70	255	225	30	600
AY4302 KOR 200 F04 Y	200	50	100	297	140x110	105x80	13.5x11	1000	30	275	223	52	200
AY4302 KOR 200 F04 M	200	50	100	297	140x110	105x80	13.5x11	1000	40	275	230	45	300
AY4302 KOR 200 F04 K	200	50	100	297	140x110	105x80	13.5x11	1000	60	275	237	38	450
AY4302 KOR 200 F04 S	200	50	100	297	140x110	105x80	13.5x11	1000	70	275	245	30	600
AY4302 KOR 250 F04 Y	250	50	120	390	140x110	105x80	13.5x11	1200	40	320	265	45	300
AY4302 KOR 250 F04 M	250	50	120	390	140x110	105x80	13.5x11	1200	60	320	273	47	450
AY4302 KOR 250 F04 K	250	50	120	390	140x110	105x80	13.5x11	1200	100	320	280	40	750
AY4302 KOR 250 F04 S	250	50	120	390	140x110	105x80	13.5x11	1200	120	320	287	33	1000

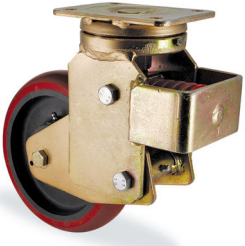

YÖN KİLİTLİ

KOR		KAMALON KASNAK ÜZERİ DÖKME POLİÜRETAN KAPLAMA RULMANLI											
KOD NO								MAKSİMUM TAŞIMA KAPASİTESİ kg	ÖN GERME KUVVETİ kg	H2 TOPLAM YÜKSEKLİK mm	H1 YÜKLÜ TOPLAM YÜKSEKLİK mm	L YAY YOLU mm	YAYIN SON KUVVETİ kg
AY4302 KOR 160 F17 Y	160	50	100	145	140x110	105x80	13.5x11	800	30	255	203	52	200
AY4302 KOR 160 F17 M	160	50	100	145	140x110	105x80	13.5x11	800	40	255	205	45	300
AY4302 KOR 160 F17 K	160	50	100	145	140x110	105x80	13.5x11	800	60	255	217	38	450
AY4302 KOR 160 F17 S	160	50	100	145	140x110	105x80	13.5x11	800	70	255	225	30	600
AY4302 KOR 200 F17 Y	200	50	100	145	140x110	105x80	13.5x11	1000	30	275	223	52	200
AY4302 KOR 200 F17 M	200	50	100	145	140x110	105x80	13.5x11	1000	40	275	230	45	300
AY4302 KOR 200 F17 K	200	50	100	145	140x110	105x80	13.5x11	1000	60	275	237	38	450
AY4302 KOR 200 F17 S	200	50	100	145	140x110	105x80	13.5x11	1000	70	275	245	30	600
AY4302 KOR 250 F17 Y	250	50	120	145	140x110	105x80	13.5x11	1200	40	320	265	45	300
AY4302 KOR 250 F17 M	250	50	120	145	140x110	105x80	13.5x11	1200	60	320	273	47	450
AY4302 KOR 250 F17 K	250	50	120	145	140x110	105x80	13.5x11	1200	100	320	280	40	750
AY4302 KOR 250 F17 S	250	50	120	145	140x110	105x80	13.5x11	1200	120	320	287	33	1000







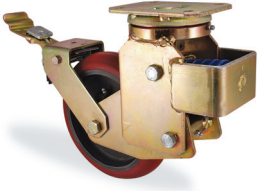

K2OR		KAMALON KASNAK ÜZERİ OVAL DÖKME POLİÜRETAN KAPLAMA RULMANLI											
KOD NO								MAKSİMUM TAŞIMA KAPASİTESİ kg	ÖN GERME KUVVETİ kg	H2 TOPLAM YÜKSEKLİK mm	H1 YÜKLÜ TOPLAM YÜKSEKLİK mm	L YAY YOLU mm	YAYIN SON KUVVETİ kg
AY4302 K2OR 160 Y	160	50	100	140x110	105x80	13.5x11	800	30	255	203	52	200	
AY4302 K2OR 160 M	160	50	100	140x110	105x80	13.5x11	800	40	255	205	45	300	
AY4302 K2OR 160 K	160	50	100	140x110	105x80	13.5x11	800	60	255	217	38	450	
AY4302 K2OR 160 S	160	50	100	140x110	105x80	13.5x11	800	70	255	225	30	600	
AY4302 K2OR 200 Y	200	50	100	140x110	105x80	13.5x11	1000	30	275	223	52	200	
AY4302 K2OR 200 M	200	50	100	140x110	105x80	13.5x11	1000	40	275	230	45	300	
AY4302 K2OR 200 K	200	50	100	140x110	105x80	13.5x11	1000	60	275	237	38	450	
AY4302 K2OR 200 S	200	50	100	140x110	105x80	13.5x11	1000	70	275	245	30	600	
AY4302 K2OR 250 Y	250	50	120	140x110	105x80	13.5x11	1200	40	320	265	45	300	
AY4302 K2OR 250 M	250	50	120	140x110	105x80	13.5x11	1200	60	320	273	47	450	
AY4302 K2OR 250 K	250	50	120	140x110	105x80	13.5x11	1200	100	320	280	40	750	
AY4302 K2OR 250 S	250	50	120	140x110	105x80	13.5x11	1200	120	320	287	33	1000	

AY4302 Serisi (Amortisörlü)



K2OR

KAMALON KASNAK ÜZERİ OVAL DÖKME POLİÜRETAN KAPLAMA RULMANLI



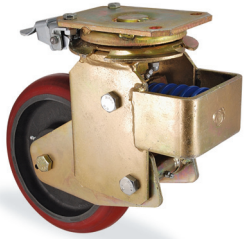



KOD NO								MAKSİMUM TAŞIMA KAPASİTESİ kg	ÖN GERME KUVVETİ kg	H2 TOPLAM YÜKSEKLİK mm	H1 YÜKLÜ TOPLAM YÜKSEKLİK mm	L YAY YOLU mm	YAYIN SON KUVVETİ kg
AY4302 K2OR 160 F04 Y	160	50	100	288.5	140x110	105x80	13.5x11	800	30	255	203	52	200
AY4302 K2OR 160 F04 M	160	50	100	288.5	140x110	105x80	13.5x11	800	40	255	205	45	300
AY4302 K2OR 160 F04 K	160	50	100	288.5	140x110	105x80	13.5x11	800	60	255	217	38	450
AY4302 K2OR 160 F04 S	160	50	100	288.5	140x110	105x80	13.5x11	800	70	255	225	30	600
AY4302 K2OR 200 F04 Y	200	50	100	297	140x110	105x80	13.5x11	1000	30	275	223	52	200
AY4302 K2OR 200 F04 M	200	50	100	297	140x110	105x80	13.5x11	1000	40	275	230	45	300
AY4302 K2OR 200 F04 K	200	50	100	297	140x110	105x80	13.5x11	1000	60	275	237	38	450
AY4302 K2OR 200 F04 S	200	50	100	297	140x110	105x80	13.5x11	1000	70	275	245	30	600
AY4302 K2OR 250 F04 Y	250	50	120	390	140x110	105x80	13.5x11	1200	40	320	265	45	300
AY4302 K2OR 250 F04 M	250	50	120	390	140x110	105x80	13.5x11	1200	60	320	273	47	450
AY4302 K2OR 250 F04 K	250	50	120	390	140x110	105x80	13.5x11	1200	100	320	280	40	750
AY4302 K2OR 250 F04 S	250	50	120	390	140x110	105x80	13.5x11	1200	120	320	287	33	1000



YÖN KİLİTLİ

K2OR

KAMALON KASNAK ÜZERİ OVAL DÖKME POLİÜRETAN KAPLAMA RULMANLI

KOD NO								MAKSİMUM TAŞIMA KAPASİTESİ kg	ÖN GERME KUVVETİ kg	H2 TOPLAM YÜKSEKLİK mm	H1 YÜKLÜ TOPLAM YÜKSEKLİK mm	L YAY YOLU mm	YAYIN SON KUVVETİ kg
AY4302 K2OR 160 F17 Y	160	50	100	145	140x110	105x80	13.5x11	800	30	255	203	52	200
AY4302 K2OR 160 F17 M	160	50	100	145	140x110	105x80	13.5x11	800	40	255	205	45	300
AY4302 K2OR 160 F17 K	160	50	100	145	140x110	105x80	13.5x11	800	60	255	217	38	450
AY4302 K2OR 160 F17 S	160	50	100	145	140x110	105x80	13.5x11	800	70	255	225	30	600
AY4302 K2OR 200 F17 Y	200	50	100	145	140x110	105x80	13.5x11	1000	30	275	223	52	200
AY4302 K2OR 200 F17 M	200	50	100	145	140x110	105x80	13.5x11	1000	40	275	230	45	300
AY4302 K2OR 200 F17 K	200	50	100	145	140x110	105x80	13.5x11	1000	60	275	237	38	450
AY4302 K2OR 200 F17 S	200	50	100	145	140x110	105x80	13.5x11	1000	70	275	245	30	600
AY4302 K2OR 250 F17 Y	250	50	120	145	140x110	105x80	13.5x11	1200	40	320	265	45	300
AY4302 K2OR 250 F17 M	250	50	120	145	140x110	105x80	13.5x11	1200	60	320	273	47	450
AY4302 K2OR 250 F17 K	250	50	120	145	140x110	105x80	13.5x11	1200	100	320	280	40	750
AY4302 K2OR 250 F17 S	250	50	120	145	140x110	105x80	13.5x11	1200	120	320	287	33	1000

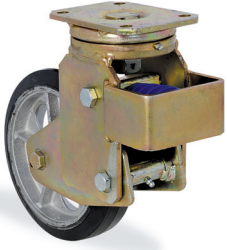

DYZ		DÖKÜM KASNAK ÜZERİ VULKANİZE LASTİK KAPLAMA RULMANLI										
KOD NO	mm	mm	mm	mm	mm	mm	MAKSİMUM TAŞIMA KAPASİTESİ kg	ÖN GERME KUVVETİ kg	H2 TOPLAM YÜKSEKLİK mm	H1 YÜKLÜ TOPLAM YÜKSEKLİK mm	L YAY YOLU mm	YAYIN SON KUVVETİ kg
AY4302 DYZ 200 Y	200	50	100	140x110	105x80	13.5x11	350	30	275	223	52	200
AY4302 DYZ 200 M	200	50	100	140x110	105x80	13.5x11	350	40	275	230	45	300
AY4302 DYZ 200 K	200	50	100	140x110	105x80	13.5x11	350	60	275	237	38	450
AY4302 DYZ 200 S	200	50	100	140x110	105x80	13.5x11	350	70	275	245	30	600

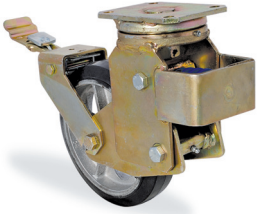

DYZ		DÖKÜM KASNAK ÜZERİ VULKANİZE LASTİK KAPLAMA RULMANLI											
KOD NO	mm	mm	mm	mm	mm	mm	mm	MAKSİMUM TAŞIMA KAPASİTESİ kg	ÖN GERME KUVVETİ kg	H2 TOPLAM YÜKSEKLİK mm	H1 YÜKLÜ TOPLAM YÜKSEKLİK mm	L YAY YOLU mm	YAYIN SON KUVVETİ kg
AY4302 DYZ 200 F04 Y	200	50	100	297	140x110	105x80	13.5x11	350	30	275	223	52	200
AY4302 DYZ 200 F04 M	200	50	100	297	140x110	105x80	13.5x11	350	40	275	230	45	300
AY4302 DYZ 200 F04 K	200	50	100	297	140x110	105x80	13.5x11	350	60	275	237	38	450
AY4302 DYZ 200 F04 S	200	50	100	297	140x110	105x80	13.5x11	350	70	275	245	30	600

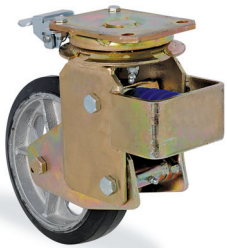

YÖN KİLİTLİ

DYZ		DÖKÜM KASNAK ÜZERİ VULKANİZE LASTİK KAPLAMA RULMANLI											
KOD NO	mm	mm	mm	mm	mm	mm	mm	MAKSİMUM TAŞIMA KAPASİTESİ kg	ÖN GERME KUVVETİ kg	H2 TOPLAM YÜKSEKLİK mm	H1 YÜKLÜ TOPLAM YÜKSEKLİK mm	L YAY YOLU mm	YAYIN SON KUVVETİ kg
AY4302 DYZ 200 F17 Y	200	50	100	145	140x110	105x80	13.5x11	350	30	275	223	52	200
AY4302 DYZ 200 F17 M	200	50	100	145	140x110	105x80	13.5x11	350	40	275	230	45	300
AY4302 DYZ 200 F17 K	200	50	100	145	140x110	105x80	13.5x11	350	60	275	237	38	450
AY4302 DYZ 200 F17 S	200	50	100	145	140x110	105x80	13.5x11	350	70	275	245	30	600

AY4302 Serisi (Amortisörlü)

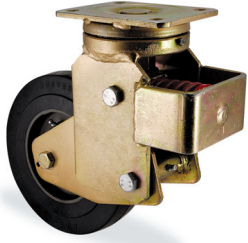

KYR		KAMALON KASNAK ÜZERİ VULKANİZE SİYAH LASTİK KAPLAMA RULMANLI										
KOD NO							MAKSİMUM TAŞIMA KAPASİTESİ kg	ÖN GERME KUVVETİ kg	H2 TOPLAM YÜKSEKLİK mm	H1 YÜKLÜ TOPLAM YÜKSEKLİK mm	L YAY YOLU mm	YAYIN SON KUVVETİ kg
AY4302 KYR 160 Y	160	50	100	140x110	105x80	13.5x11	240	30	255	203	52	200
AY4302 KYR 160 M	160	50	100	140x110	105x80	13.5x11	240	40	255	205	45	300
AY4302 KYR 160 K	160	50	100	140x110	105x80	13.5x11	240	60	255	217	38	450
AY4302 KYR 160 S	160	50	100	140x110	105x80	13.5x11	240	70	255	225	30	600
AY4302 KYR 200 Y	200	50	100	140x110	105x80	13.5x11	350	30	275	223	52	200
AY4302 KYR 200 M	200	50	100	140x110	105x80	13.5x11	350	40	275	230	45	300
AY4302 KYR 200 K	200	50	100	140x110	105x80	13.5x11	350	60	275	237	38	450
AY4302 KYR 200 S	200	50	100	140x110	105x80	13.5x11	350	70	275	245	30	600
AY4302 KYR 250 Y	250	50	120	140x110	105x80	13.5x11	500	40	320	265	45	300
AY4302 KYR 250 M	250	50	120	140x110	105x80	13.5x11	500	60	320	273	47	450
AY4302 KYR 250 K	250	50	120	140x110	105x80	13.5x11	500	100	320	280	40	750
AY4302 KYR 250 S	250	50	120	140x110	105x80	13.5x11	500	120	320	287	33	1000

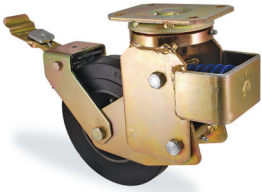

KYR		KAMALON KASNAK ÜZERİ VULKANİZE SİYAH LASTİK KAPLAMA RULMANLI											
KOD NO							MAKSİMUM TAŞIMA KAPASİTESİ kg	ÖN GERME KUVVETİ kg	H2 TOPLAM YÜKSEKLİK mm	H1 YÜKLÜ TOPLAM YÜKSEKLİK mm	L YAY YOLU mm	YAYIN SON KUVVETİ kg	
AY4302 KYR 160 F04 Y	160	50	100	288.5	140x110	105x80	13.5x11	240	30	255	203	52	200
AY4302 KYR 160 F04 M	160	50	100	288.5	140x110	105x80	13.5x11	240	40	255	205	45	300
AY4302 KYR 160 F04 K	160	50	100	288.5	140x110	105x80	13.5x11	240	60	255	217	38	450
AY4302 KYR 160 F04 S	160	50	100	288.5	140x110	105x80	13.5x11	240	70	255	225	30	600
AY4302 KYR 200 F04 Y	200	50	100	297	140x110	105x80	13.5x11	350	30	275	223	52	200
AY4302 KYR 200 F04 M	200	50	100	297	140x110	105x80	13.5x11	350	40	275	230	45	300
AY4302 KYR 200 F04 K	200	50	100	297	140x110	105x80	13.5x11	350	60	275	237	38	450
AY4302 KYR 200 F04 S	200	50	100	297	140x110	105x80	13.5x11	350	70	275	245	30	600
AY4302 KYR 250 F04 Y	250	50	120	390	140x110	105x80	13.5x11	500	40	320	265	45	300
AY4302 KYR 250 F04 M	250	50	120	390	140x110	105x80	13.5x11	500	60	320	273	47	450
AY4302 KYR 250 F04 K	250	50	120	390	140x110	105x80	13.5x11	500	100	320	280	40	750
AY4302 KYR 250 F04 S	250	50	120	390	140x110	105x80	13.5x11	500	120	320	287	33	1000

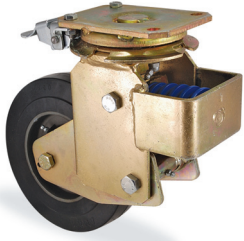

YÖN KİLİTLİ

KYR		KAMALON KASNAK ÜZERİ VULKANİZE SİYAH LASTİK KAPLAMA RULMANLI											
KOD NO								MAKSİMUM TAŞIMA KAPASİTESİ	ÖN GERME KUVVETİ	H2 TOPLAM YÜKSEKLİK	H1 YÜKLÜ TOPLAM YÜKSEKLİK	L YAY YOLU	YAYIN SON KUVVETİ
	mm	mm	mm	mm	mm	mm	mm	kg	kg	mm	mm	mm	kg
AY4302 KYR 160 F17 Y	160	50	100	145	140x110	105x80	13.5x11	240	30	255	203	52	200
AY4302 KYR 160 F17 M	160	50	100	145	140x110	105x80	13.5x11	240	40	255	205	45	300
AY4302 KYR 160 F17 K	160	50	100	145	140x110	105x80	13.5x11	240	60	255	217	38	450
AY4302 KYR 160 F17 S	160	50	100	145	140x110	105x80	13.5x11	240	70	255	225	30	600
AY4302 KYR 200 F17 Y	200	50	100	145	140x110	105x80	13.5x11	350	30	275	223	52	200
AY4302 KYR 200 F17 M	200	50	100	145	140x110	105x80	13.5x11	350	40	275	230	45	300
AY4302 KYR 200 F17 K	200	50	100	145	140x110	105x80	13.5x11	350	60	275	237	38	450
AY4302 KYR 200 F17 S	200	50	100	145	140x110	105x80	13.5x11	350	70	275	245	30	600
AY4302 KYR 250 F17 Y	250	50	120	145	140x110	105x80	13.5x11	500	40	320	265	45	300
AY4302 KYR 250 F17 M	250	50	120	145	140x110	105x80	13.5x11	500	60	320	273	47	450
AY4302 KYR 250 F17 K	250	50	120	145	140x110	105x80	13.5x11	500	100	320	280	40	750
AY4302 KYR 250 F17 S	250	50	120	145	140x110	105x80	13.5x11	500	120	320	287	33	1000

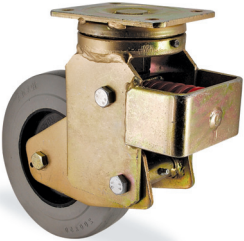

KER		KAMALON KASNAK ÜZERİ VULKANİZE GRİ LASTİK KAPLAMA RULMANLI											
KOD NO								MAKSİMUM TAŞIMA KAPASİTESİ	ÖN GERME KUVVETİ	H2 TOPLAM YÜKSEKLİK	H1 YÜKLÜ TOPLAM YÜKSEKLİK	L YAY YOLU	YAYIN SON KUVVETİ
	mm	mm	mm	mm	mm	mm	mm	kg	kg	mm	mm	mm	kg
AY4302 KER 160 Y	160	50	100	140x110	105x80	13.5x11	240	30	255	203	52	200	
AY4302 KER 160 M	160	50	100	140x110	105x80	13.5x11	240	40	255	205	45	300	
AY4302 KER 160 K	160	50	100	140x110	105x80	13.5x11	240	60	255	217	38	450	
AY4302 KER 160 S	160	50	100	140x110	105x80	13.5x11	240	70	255	225	30	600	
AY4302 KER 200 Y	200	50	100	140x110	105x80	13.5x11	350	30	275	223	52	200	
AY4302 KER 200 M	200	50	100	140x110	105x80	13.5x11	350	40	275	230	45	300	
AY4302 KER 200 K	200	50	100	140x110	105x80	13.5x11	350	60	275	237	38	450	
AY4302 KER 200 S	200	50	100	140x110	105x80	13.5x11	350	70	275	245	30	600	
AY4302 KER 250 Y	250	50	120	140x110	105x80	13.5x11	500	40	320	265	45	300	
AY4302 KER 250 M	250	50	120	140x110	105x80	13.5x11	500	60	320	273	47	450	
AY4302 KER 250 K	250	50	120	140x110	105x80	13.5x11	500	100	320	280	40	750	
AY4302 KER 250 S	250	50	120	140x110	105x80	13.5x11	500	120	320	287	33	1000	



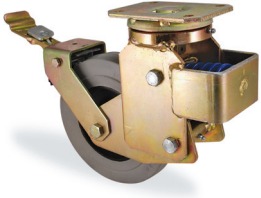

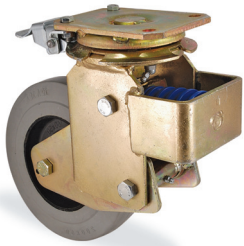

AY4302 Serisi (Amortisörlü)









KER		KAMALON KASNAK ÜZERİ VULKANİZE GRİ LASTİK KAPLAMA RULMANLI											
KOD NO								MAKSİMUM TAŞIMA KAPASİTESİ kg	ÖN GERME KUVVETİ kg	H2 TOPLAM YÜKSEKLİK mm	H1 YÜKLÜ TOPLAM YÜKSEKLİK mm	L YAY YOLU mm	YAYIN SON KUVVETİ kg
AY4302 KER 160 F04 Y	160	50	100	288.5	140x110	105x80	13.5x11	240	30	255	203	52	200
AY4302 KER 160 F04 M	160	50	100	288.5	140x110	105x80	13.5x11	240	40	255	205	45	300
AY4302 KER 160 F04 K	160	50	100	288.5	140x110	105x80	13.5x11	240	60	255	217	38	450
AY4302 KER 160 F04 S	160	50	100	288.5	140x110	105x80	13.5x11	240	70	255	225	30	600
AY4302 KER 200 F04 Y	200	50	100	297	140x110	105x80	13.5x11	350	30	275	223	52	200
AY4302 KER 200 F04 M	200	50	100	297	140x110	105x80	13.5x11	350	40	275	230	45	300
AY4302 KER 200 F04 K	200	50	100	297	140x110	105x80	13.5x11	350	60	275	237	38	450
AY4302 KER 200 F04 S	200	50	100	297	140x110	105x80	13.5x11	350	70	275	245	30	600
AY4302 KER 250 F04 Y	250	50	120	390	140x110	105x80	13.5x11	500	40	320	265	45	300
AY4302 KER 250 F04 M	250	50	120	390	140x110	105x80	13.5x11	500	60	320	273	47	450
AY4302 KER 250 F04 K	250	50	120	390	140x110	105x80	13.5x11	500	100	320	280	40	750
AY4302 KER 250 F04 S	250	50	120	390	140x110	105x80	13.5x11	500	120	320	287	33	1000

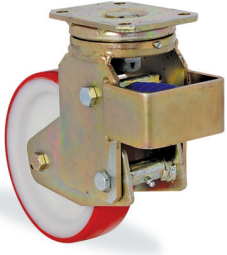







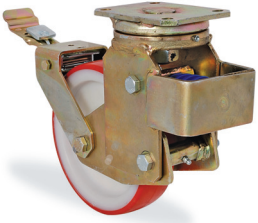

YÖN KİLİTLİ

KER		KAMALON KASNAK ÜZERİ VULKANİZE GRİ LASTİK KAPLAMA RULMANLI											
KOD NO								MAKSİMUM TAŞIMA KAPASİTESİ kg	ÖN GERME KUVVETİ kg	H2 TOPLAM YÜKSEKLİK mm	H1 YÜKLÜ TOPLAM YÜKSEKLİK mm	L YAY YOLU mm	YAYIN SON KUVVETİ kg
AY4302 KER 160 F17 Y	160	50	100	145	140x110	105x80	13.5x11	240	30	255	203	52	200
AY4302 KER 160 F17 M	160	50	100	145	140x110	105x80	13.5x11	240	40	255	205	45	300
AY4302 KER 160 F17 K	160	50	100	145	140x110	105x80	13.5x11	240	60	255	217	38	450
AY4302 KER 160 F17 S	160	50	100	145	140x110	105x80	13.5x11	240	70	255	225	30	600
AY4302 KER 200 F17 Y	200	50	100	145	140x110	105x80	13.5x11	350	30	275	223	52	200
AY4302 KER 200 F17 M	200	50	100	145	140x110	105x80	13.5x11	350	40	275	230	45	300
AY4302 KER 200 F17 K	200	50	100	145	140x110	105x80	13.5x11	350	60	275	237	38	450
AY4302 KER 200 F17 S	200	50	100	145	140x110	105x80	13.5x11	350	70	275	245	30	600
AY4302 KER 250 F17 Y	250	50	120	145	140x110	105x80	13.5x11	500	40	320	265	45	300
AY4302 KER 250 F17 M	250	50	120	145	140x110	105x80	13.5x11	500	60	320	273	47	450
AY4302 KER 250 F17 K	250	50	120	145	140x110	105x80	13.5x11	500	100	320	280	40	750
AY4302 KER 250 F17 S	250	50	120	145	140x110	105x80	13.5x11	500	120	320	287	33	1000





PUR		POLİAMİD KASNAK ÜZERİ POLİÜRETAN KAPLAMA RULMANLI										
KOD NO	 mm	 mm	 mm	 mm	 mm	 mm	MAKSİMUM TAŞIMA KAPASİTESİ kg	ÖN GERME KUVVETİ kg	H2 TOPLAM YÜKSEKLİK mm	H1 YÜKLÜ TOPLAM YÜKSEKLİK mm	L YAY YOLU mm	YAYIN SON KUVVETİ kg
AY4302 PUR 200 Y	200	50	100	140x110	105x80	13.5x11	600	30	275	223	52	200
AY4302 PUR 200 M	200	50	100	140x110	105x80	13.5x11	600	40	275	230	45	300
AY4302 PUR 200 K	200	50	100	140x110	105x80	13.5x11	600	60	275	237	38	450
AY4302 PUR 200 S	200	50	100	140x110	105x80	13.5x11	600	70	275	245	30	600



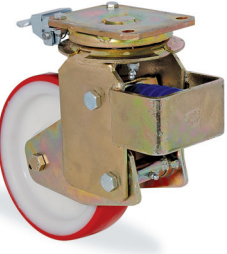



PUR		POLİAMİD KASNAK ÜZERİ POLİÜRETAN KAPLAMA RULMANLI											
KOD NO	 mm	 mm	 mm	 mm	 mm	 mm	 mm	MAKSİMUM TAŞIMA KAPASİTESİ kg	ÖN GERME KUVVETİ kg	H2 TOPLAM YÜKSEKLİK mm	H1 YÜKLÜ TOPLAM YÜKSEKLİK mm	L YAY YOLU mm	YAYIN SON KUVVETİ kg
AY4302 PUR 200 F04 Y	200	50	100	297	140x110	105x80	13.5x11	600	30	275	223	52	200
AY4302 PUR 200 F04 M	200	50	100	297	140x110	105x80	13.5x11	600	40	275	230	45	300
AY4302 PUR 200 F04 K	200	50	100	297	140x110	105x80	13.5x11	600	60	275	237	38	450
AY4302 PUR 200 F04 S	200	50	100	297	140x110	105x80	13.5x11	600	70	275	245	30	600

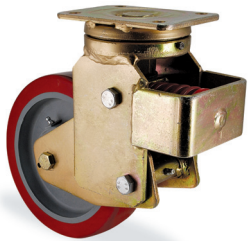

YÖN KİLİTLİ

PUR		POLİAMİD KASNAK ÜZERİ POLİÜRETAN KAPLAMA RULMANLI											
KOD NO	 mm	 mm	 mm	 mm	 mm	 mm	 mm	MAKSİMUM TAŞIMA KAPASİTESİ kg	ÖN GERME KUVVETİ kg	H2 TOPLAM YÜKSEKLİK mm	H1 YÜKLÜ TOPLAM YÜKSEKLİK mm	L YAY YOLU mm	YAYIN SON KUVVETİ kg
AY4302 PUR 200 F17 Y	200	50	100	145	140x110	105x80	13.5x11	600	30	275	223	52	200
AY4302 PUR 200 F17 M	200	50	100	145	140x110	105x80	13.5x11	600	40	275	230	45	300
AY4302 PUR 200 F17 K	200	50	100	145	140x110	105x80	13.5x11	600	60	275	237	38	450
AY4302 PUR 200 F17 S	200	50	100	145	140x110	105x80	13.5x11	600	70	275	245	30	600







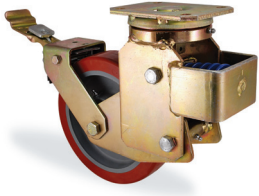

KUR		KAMALON KASNAK ÜZERİ ENJEKSİYON POLİÜRETAN KAPLAMA RULMANLI											
KOD NO	 mm	 mm	 mm	 mm	 mm	 mm	 mm	MAKSİMUM TAŞIMA KAPASİTESİ kg	ÖN GERME KUVVETİ kg	H2 TOPLAM YÜKSEKLİK mm	H1 YÜKLÜ TOPLAM YÜKSEKLİK mm	L YAY YOLU mm	YAYIN SON KUVVETİ kg
AY4302 KUR 160 Y	160	50	100	140x110	105x80	13.5x11	650	30	255	203	52	200	
AY4302 KUR 160 M	160	50	100	140x110	105x80	13.5x11	650	40	255	205	45	300	
AY4302 KUR 160 K	160	50	100	140x110	105x80	13.5x11	650	60	255	217	38	450	
AY4302 KUR 160 S	160	50	100	140x110	105x80	13.5x11	650	70	255	225	30	600	
AY4302 KUR 200 Y	200	50	100	140x110	105x80	13.5x11	800	30	275	223	52	200	
AY4302 KUR 200 M	200	50	100	140x110	105x80	13.5x11	800	40	275	230	45	300	
AY4302 KUR 200 K	200	50	100	140x110	105x80	13.5x11	800	60	275	237	38	450	
AY4302 KUR 200 S	200	50	100	140x110	105x80	13.5x11	800	70	275	245	30	600	

AY4302 Serisi (Amortisörlü)



KUR

KAMALON KASNAK ÜZERİ ENJEKSİYON POLİÜRETAN KAPLAMA RULMANLI



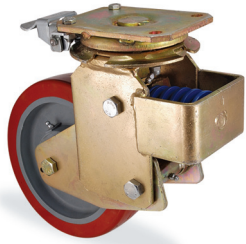



KOD NO								MAKSİMUM TAŞIMA KAPASİTESİ kg	ÖN GERME KUVVETİ kg	H2 TOPLAM YÜKSEKLİK mm	H1 YÜKLÜ TOPLAM YÜKSEKLİK mm	L YAY YOLU mm	YAYIN SON KUVVETİ kg
AY4302 KUR 160 F04 Y	160	50	100	288.5	140x110	105x80	13.5x11	650	30	255	203	52	200
AY4302 KUR 160 F04 M	160	50	100	288.5	140x110	105x80	13.5x11	650	40	255	205	45	300
AY4302 KUR 160 F04 K	160	50	100	288.5	140x110	105x80	13.5x11	650	60	255	217	38	450
AY4302 KUR 160 F04 S	160	50	100	288.5	140x110	105x80	13.5x11	650	70	255	225	30	600
AY4302 KUR 200 F04 Y	200	50	100	297	140x110	105x80	13.5x11	800	30	275	223	52	200
AY4302 KUR 200 F04 M	200	50	100	297	140x110	105x80	13.5x11	800	40	275	230	45	300
AY4302 KUR 200 F04 K	200	50	100	297	140x110	105x80	13.5x11	800	60	275	237	38	450
AY4302 KUR 200 F04 S	200	50	100	297	140x110	105x80	13.5x11	800	70	275	245	30	600



YÖN KİLİTLİ

KUR





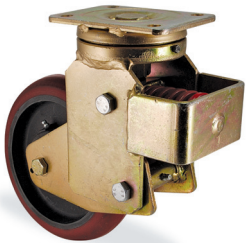

KAMALON KASNAK ÜZERİ ENJEKSİYON POLİÜRETAN KAPLAMA RULMANLI

KOD NO								MAKSİMUM TAŞIMA KAPASİTESİ kg	ÖN GERME KUVVETİ kg	H2 TOPLAM YÜKSEKLİK mm	H1 YÜKLÜ TOPLAM YÜKSEKLİK mm	L YAY YOLU mm	YAYIN SON KUVVETİ kg
AY4302 KUR 160 F17 Y	160	50	100	145	140x110	105x80	13.5x11	650	30	255	203	52	200
AY4302 KUR 160 F17 M	160	50	100	145	140x110	105x80	13.5x11	650	40	255	205	45	300
AY4302 KUR 160 F17 K	160	50	100	145	140x110	105x80	13.5x11	650	60	255	217	38	450
AY4302 KUR 160 F17 S	160	50	100	145	140x110	105x80	13.5x11	650	70	255	225	30	600
AY4302 KUR 200 F17 Y	200	50	100	145	140x110	105x80	13.5x11	800	30	275	223	52	200
AY4302 KUR 200 F17 M	200	50	100	145	140x110	105x80	13.5x11	800	40	275	230	45	300
AY4302 KUR 200 F17 K	200	50	100	145	140x110	105x80	13.5x11	800	60	275	237	38	450
AY4302 KUR 200 F17 S	200	50	100	145	140x110	105x80	13.5x11	800	70	275	245	30	600



K2UR





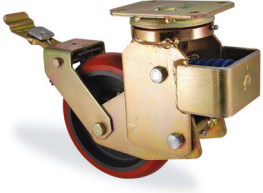

KAMALON KASNAK ÜZERİ OVAL ENJEKSİYON POLİÜRETAN KAPLAMA RULMANLI

KOD NO								MAKSİMUM TAŞIMA KAPASİTESİ kg	ÖN GERME KUVVETİ kg	H2 TOPLAM YÜKSEKLİK mm	H1 YÜKLÜ TOPLAM YÜKSEKLİK mm	L YAY YOLU mm	YAYIN SON KUVVETİ kg
AY4302 K2UR 160 Y	160	50	100	140x110	105x80	13.5x11	650	30	255	203	52	200	
AY4302 K2UR 160 M	160	50	100	140x110	105x80	13.5x11	650	40	255	205	45	300	
AY4302 K2UR 160 K	160	50	100	140x110	105x80	13.5x11	650	60	255	217	38	450	
AY4302 K2UR 160 S	160	50	100	140x110	105x80	13.5x11	650	70	255	225	30	600	
AY4302 K2UR 200 Y	200	50	100	140x110	105x80	13.5x11	800	30	275	223	52	200	
AY4302 K2UR 200 M	200	50	100	140x110	105x80	13.5x11	800	40	275	230	45	300	
AY4302 K2UR 200 K	200	50	100	140x110	105x80	13.5x11	800	60	275	237	38	450	
AY4302 K2UR 200 S	200	50	100	140x110	105x80	13.5x11	800	70	275	245	30	600	



K2UR

KAMALON KASNAK ÜZERİ OVAL ENJEKSİYON POLİÜRETAN KAPLAMA RULMANLI



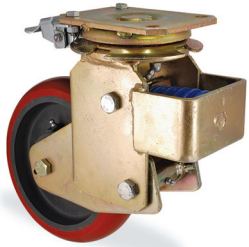



KOD NO								MAKSİMUM TAŞIMA KAPASİTESİ kg	ÖN GERME KUVVETİ kg	H2 TOPLAM YÜKSEKLİK mm	H1 YÜKLÜ TOPLAM YÜKSEKLİK mm	L YAY YOLU mm	YAYIN SON KUVVETİ kg
AY4302 K2UR 160 F04 Y	160	50	100	288.5	140x110	105x80	13.5x11	650	30	255	203	52	200
AY4302 K2UR 160 F04 M	160	50	100	288.5	140x110	105x80	13.5x11	650	40	255	205	45	300
AY4302 K2UR 160 F04 K	160	50	100	288.5	140x110	105x80	13.5x11	650	60	255	217	38	450
AY4302 K2UR 160 F04 S	160	50	100	288.5	140x110	105x80	13.5x11	650	70	255	225	30	600
AY4302 K2UR 200 F04 Y	200	50	100	297	140x110	105x80	13.5x11	800	30	275	223	52	200
AY4302 K2UR 200 F04 M	200	50	100	297	140x110	105x80	13.5x11	800	40	275	230	45	300
AY4302 K2UR 200 F04 K	200	50	100	297	140x110	105x80	13.5x11	800	60	275	237	38	450
AY4302 K2UR 200 F04 S	200	50	100	297	140x110	105x80	13.5x11	800	70	275	245	30	600



YÖN KİLİTLİ

K2UR





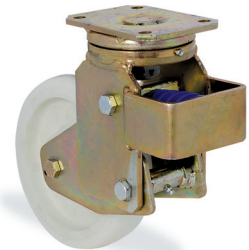

KAMALON KASNAK ÜZERİ OVAL ENJEKSİYON POLİÜRETAN KAPLAMA RULMANLI

KOD NO								MAKSİMUM TAŞIMA KAPASİTESİ kg	ÖN GERME KUVVETİ kg	H2 TOPLAM YÜKSEKLİK mm	H1 YÜKLÜ TOPLAM YÜKSEKLİK mm	L YAY YOLU mm	YAYIN SON KUVVETİ kg
AY4302 K2UR 160 F17 Y	160	50	100	145	140x110	105x80	13.5x11	650	30	255	203	52	200
AY4302 K2UR 160 F17 M	160	50	100	145	140x110	105x80	13.5x11	650	40	255	205	45	300
AY4302 K2UR 160 F17 K	160	50	100	145	140x110	105x80	13.5x11	650	60	255	217	38	450
AY4302 K2UR 160 F17 S	160	50	100	145	140x110	105x80	13.5x11	650	70	255	225	30	600
AY4302 K2UR 200 F17 Y	200	50	100	145	140x110	105x80	13.5x11	800	30	275	223	52	200
AY4302 K2UR 200 F17 M	200	50	100	145	140x110	105x80	13.5x11	800	40	275	230	45	300
AY4302 K2UR 200 F17 K	200	50	100	145	140x110	105x80	13.5x11	800	60	275	237	38	450
AY4302 K2UR 200 F17 S	200	50	100	145	140x110	105x80	13.5x11	800	70	275	245	30	600









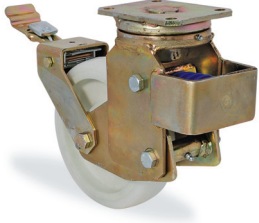

RPR

AĞIR TİP POLİAMİD TEKER RULMANLI

KOD NO								MAKSİMUM TAŞIMA KAPASİTESİ kg	ÖN GERME KUVVETİ kg	H2 TOPLAM YÜKSEKLİK mm	H1 YÜKLÜ TOPLAM YÜKSEKLİK mm	L YAY YOLU mm	YAYIN SON KUVVETİ kg
AY4302 RPR 200 Y	200	50	100	140x110	105x80	13.5x11	900	30	275	223	52	200	
AY4302 RPR 200 M	200	50	100	140x110	105x80	13.5x11	900	40	275	230	45	300	
AY4302 RPR 200 K	200	50	100	140x110	105x80	13.5x11	900	60	275	237	38	450	
AY4302 RPR 200 S	200	50	100	140x110	105x80	13.5x11	900	70	275	245	30	600	





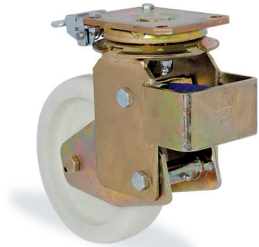

AY4302 Serisi (Amortisörlü)







RPR		AĞIR TİP POLİAMİD TEKER RULMANLI											
KOD NO								MAKSİMUM TAŞIMA KAPASİTESİ kg	ÖN GERME KUVVETİ kg	H2 TOPLAM YÜKSEKLİK mm	H1 YÜKLÜ TOPLAM YÜKSEKLİK mm	L YAY YOLU mm	YAYIN SON KUVVETİ kg
AY4302 RPR 200 F04 Y	200	50	100	297	140x110	105x80	13.5x11	900	30	275	223	52	200
AY4302 RPR 200 F04 M	200	50	100	297	140x110	105x80	13.5x11	900	40	275	230	45	300
AY4302 RPR 200 F04 K	200	50	100	297	140x110	105x80	13.5x11	900	60	275	237	38	450
AY4302 RPR 200 F04 S	200	50	100	297	140x110	105x80	13.5x11	900	70	275	245	30	600

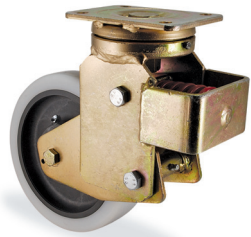

YÖN KİLİTLİ

RPR		AĞIR TİP POLİAMİD TEKER RULMANLI											
KOD NO								MAKSİMUM TAŞIMA KAPASİTESİ kg	ÖN GERME KUVVETİ kg	H2 TOPLAM YÜKSEKLİK mm	H1 YÜKLÜ TOPLAM YÜKSEKLİK mm	L YAY YOLU mm	YAYIN SON KUVVETİ kg
AY4302 RPR 200 F17 Y	200	50	100	145	140x110	105x80	13.5x11	900	30	275	223	52	200
AY4302 RPR 200 F17 M	200	50	100	145	140x110	105x80	13.5x11	900	40	275	230	45	300
AY4302 RPR 200 F17 K	200	50	100	145	140x110	105x80	13.5x11	900	60	275	237	38	450
AY4302 RPR 200 F17 S	200	50	100	145	140x110	105x80	13.5x11	900	70	275	245	30	600



KPR		KAMALON KASNAK ÜZERİ POLİAMİD KAPLAMA RULMANLI											
KOD NO								MAKSİMUM TAŞIMA KAPASİTESİ kg	ÖN GERME KUVVETİ kg	H2 TOPLAM YÜKSEKLİK mm	H1 YÜKLÜ TOPLAM YÜKSEKLİK mm	L YAY YOLU mm	YAYIN SON KUVVETİ kg
AY4302 KPR 160 Y	160	50	100	140x110	105x80	13.5x11	800	30	255	203	52	200	
AY4302 KPR 160 M	160	50	100	140x110	105x80	13.5x11	800	40	255	205	45	300	
AY4302 KPR 160 K	160	50	100	140x110	105x80	13.5x11	800	60	255	217	38	450	
AY4302 KPR 160 S	160	50	100	140x110	105x80	13.5x11	800	70	255	225	30	600	
AY4302 KPR 200 Y	200	50	100	140x110	105x80	13.5x11	1000	30	275	223	52	200	
AY4302 KPR 200 M	200	50	100	140x110	105x80	13.5x11	1000	40	275	230	45	300	
AY4302 KPR 200 K	200	50	100	140x110	105x80	13.5x11	1000	60	275	237	38	450	
AY4302 KPR 200 S	200	50	100	140x110	105x80	13.5x11	1000	70	275	245	30	600	

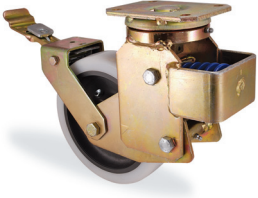

KPR		KAMALON KASNAK ÜZERİ POLİAMİD KAPLAMA RULMANLI											
KOD NO								MAKSİMUM TAŞIMA KAPASİTESİ kg	ÖN GERME KUVVETİ kg	H2 TOPLAM YÜKSEKLİK mm	H1 YÜKLÜ TOPLAM YÜKSEKLİK mm	L YAY YOLU mm	YAYIN SON KUVVETİ kg
AY4302 KPR 160 F04 Y	160	50	100	288.5	140x110	105x80	13.5x11	800	30	255	203	52	200
AY4302 KPR 160 F04 M	160	50	100	288.5	140x110	105x80	13.5x11	800	40	255	205	45	300
AY4302 KPR 160 F04 K	160	50	100	288.5	140x110	105x80	13.5x11	800	60	255	217	38	450
AY4302 KPR 160 F04 S	160	50	100	288.5	140x110	105x80	13.5x11	800	70	255	225	30	600
AY4302 KPR 200 F04 Y	200	50	100	297	140x110	105x80	13.5x11	1000	30	275	223	52	200
AY4302 KPR 200 F04 M	200	50	100	297	140x110	105x80	13.5x11	1000	40	275	230	45	300
AY4302 KPR 200 F04 K	200	50	100	297	140x110	105x80	13.5x11	1000	60	275	237	38	450
AY4302 KPR 200 F04 S	200	50	100	297	140x110	105x80	13.5x11	1000	70	275	245	30	600

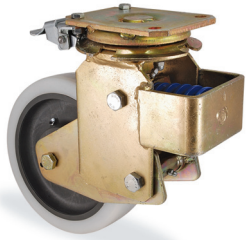

YÖN KİLİTLİ

KPR		KAMALON KASNAK ÜZERİ POLİAMİD KAPLAMA RULMANLI											
KOD NO								MAKSİMUM TAŞIMA KAPASİTESİ kg	ÖN GERME KUVVETİ kg	H2 TOPLAM YÜKSEKLİK mm	H1 YÜKLÜ TOPLAM YÜKSEKLİK mm	L YAY YOLU mm	YAYIN SON KUVVETİ kg
AY4302 KPR 160 F17 Y	160	50	100	145	140x110	105x80	13.5x11	800	30	255	203	52	200
AY4302 KPR 160 F17 M	160	50	100	145	140x110	105x80	13.5x11	800	40	255	205	45	300
AY4302 KPR 160 F17 K	160	50	100	145	140x110	105x80	13.5x11	800	60	255	217	38	450
AY4302 KPR 160 F17 S	160	50	100	145	140x110	105x80	13.5x11	800	70	255	225	30	600
AY4302 KPR 200 F17 Y	200	50	100	145	140x110	105x80	13.5x11	1000	30	275	223	52	200
AY4302 KPR 200 F17 M	200	50	100	145	140x110	105x80	13.5x11	1000	40	275	230	45	300
AY4302 KPR 200 F17 K	200	50	100	145	140x110	105x80	13.5x11	1000	60	275	237	38	450
AY4302 KPR 200 F17 S	200	50	100	145	140x110	105x80	13.5x11	1000	70	275	245	30	600

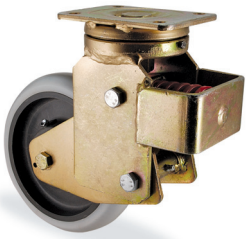





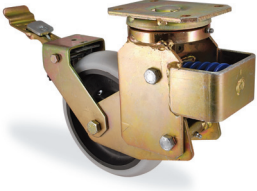

K2PR		KAMALON KASNAK ÜZERİ OVAL POLİAMİD KAPLAMA RULMANLI											
KOD NO							MAKSİMUM TAŞIMA KAPASİTESİ kg	ÖN GERME KUVVETİ kg	H2 TOPLAM YÜKSEKLİK mm	H1 YÜKLÜ TOPLAM YÜKSEKLİK mm	L YAY YOLU mm	YAYIN SON KUVVETİ kg	
AY4302 K2PR 160 Y	160	50	100	140x110	105x80	13.5x11	800	30	255	203	52	200	
AY4302 K2PR 160 M	160	50	100	140x110	105x80	13.5x11	800	40	255	205	45	300	
AY4302 K2PR 160 K	160	50	100	140x110	105x80	13.5x11	800	60	255	217	38	450	
AY4302 K2PR 160 S	160	50	100	140x110	105x80	13.5x11	800	70	255	225	30	600	
AY4302 K2PR 200 Y	200	50	100	140x110	105x80	13.5x11	1000	30	275	223	52	200	
AY4302 K2PR 200 M	200	50	100	140x110	105x80	13.5x11	1000	40	275	230	45	300	
AY4302 K2PR 200 K	200	50	100	140x110	105x80	13.5x11	1000	60	275	237	38	450	
AY4302 K2PR 200 S	200	50	100	140x110	105x80	13.5x11	1000	70	275	245	30	600	

AY4302 Serisi (Amortisörlü)



K2PR

KAMALON KASNAK ÜZERİ OVAL POLİAMİD KAPLAMA RULMANLI



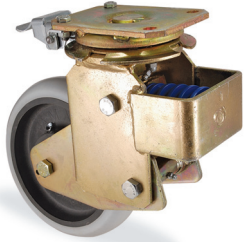



KOD NO	 mm	 mm	 mm	 mm	 mm	 mm	MAKSİMUM TAŞIMA KAPASİTESİ kg	ÖN GERME KUVVETİ kg	H2 TOPLAM YÜKSEKLİK mm	H1 YÜKLÜ TOPLAM YÜKSEKLİK mm	L YAY YOLU mm	YAYIN SON KUVVETİ kg	
AY4302 K2PR 160 F04 Y	160	50	100	288.5	140x110	105x80	13.5x11	800	30	255	203	52	200
AY4302 K2PR 160 F04 M	160	50	100	288.5	140x110	105x80	13.5x11	800	40	255	205	45	300
AY4302 K2PR 160 F04 K	160	50	100	288.5	140x110	105x80	13.5x11	800	60	255	217	38	450
AY4302 K2PR 160 F04 S	160	50	100	288.5	140x110	105x80	13.5x11	800	70	255	225	30	600
AY4302 K2PR 200 F04 Y	200	50	100	297	140x110	105x80	13.5x11	1000	30	275	223	52	200
AY4302 K2PR 200 F04 M	200	50	100	297	140x110	105x80	13.5x11	1000	40	275	230	45	300
AY4302 K2PR 200 F04 K	200	50	100	297	140x110	105x80	13.5x11	1000	60	275	237	38	450
AY4302 K2PR 200 F04 S	200	50	100	297	140x110	105x80	13.5x11	1000	70	275	245	30	600



YÖN KİLİTLİ

K2PR

KAMALON KASNAK ÜZERİ OVAL POLİAMİD KAPLAMA RULMANLI

KOD NO	 mm	 mm	 mm	 mm	 mm	 mm	MAKSİMUM TAŞIMA KAPASİTESİ kg	ÖN GERME KUVVETİ kg	H2 TOPLAM YÜKSEKLİK mm	H1 YÜKLÜ TOPLAM YÜKSEKLİK mm	L YAY YOLU mm	YAYIN SON KUVVETİ kg	
AY4302 K2PR 160 F17 Y	160	50	100	145	140x110	105x80	13.5x11	800	30	255	203	52	200
AY4302 K2PR 160 F17 M	160	50	100	145	140x110	105x80	13.5x11	800	40	255	205	45	300
AY4302 K2PR 160 F17 K	160	50	100	145	140x110	105x80	13.5x11	800	60	255	217	38	450
AY4302 K2PR 160 F17 S	160	50	100	145	140x110	105x80	13.5x11	800	70	255	225	30	600
AY4302 K2PR 200 F17 Y	200	50	100	145	140x110	105x80	13.5x11	1000	30	275	223	52	200
AY4302 K2PR 200 F17 M	200	50	100	145	140x110	105x80	13.5x11	1000	40	275	230	45	300
AY4302 K2PR 200 F17 K	200	50	100	145	140x110	105x80	13.5x11	1000	60	275	237	38	450
AY4302 K2PR 200 F17 S	200	50	100	145	140x110	105x80	13.5x11	1000	70	275	245	30	600

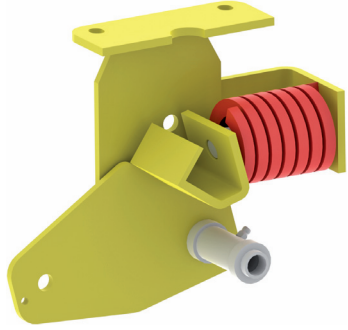



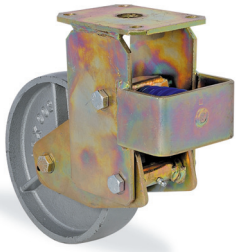
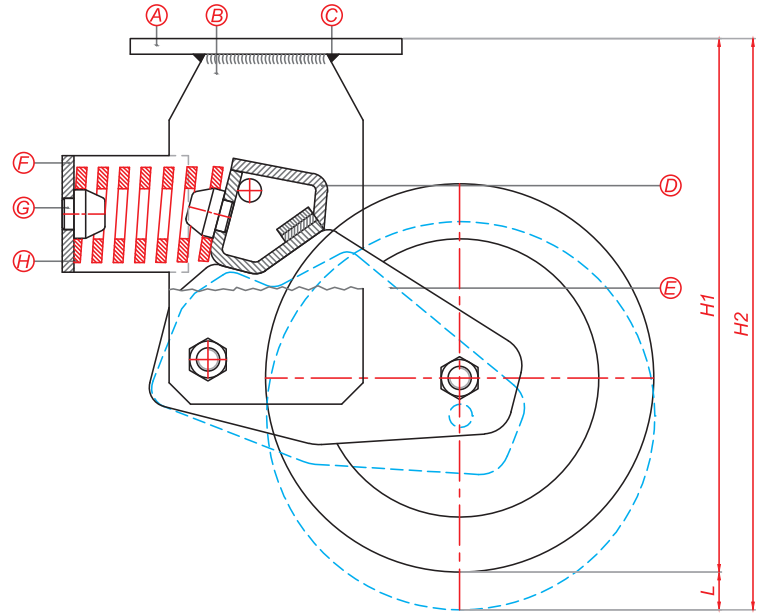



- A:** SABİT TABLA
- B:** MAŞA AYAĞI
- C:** MAŞA AYAK KAYNAĞI
- D:** YAY DESTEK SACI
- E:** HAREKETLİ MAŞA AYAĞI
- F:** YAY DESTEK SACI
- G:** YAY TOPUZU
- H:** AMORTİSÖR YAYI



DDR





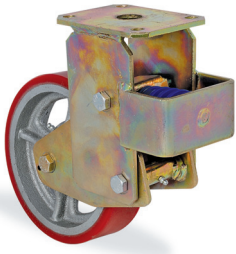

DÖKÜM TEKER RULMANLI

KOD NO	 mm	 mm	 mm	 mm	 mm	 mm	MAKSİMUM TAŞIMA KAPASİTESİ kg	ÖN GERME KUVVETİ kg	H2 TOPLAM YÜKSEKLİK mm	H1 YÜKLÜ TOPLAM YÜKSEKLİK mm	L YAY YOLU mm	YAYIN SON KUVVETİ kg
AY4307 DDR 200 Y	200	50	100	140x110	105x80	13.5x11	1100	30	275	223	52	200
AY4307 DDR 200 M	200	50	100	140x110	105x80	13.5x11	1100	40	275	230	45	300
AY4307 DDR 200 K	200	50	100	140x110	105x80	13.5x11	1100	60	275	237	38	450
AY4307 DDR 200 S	200	50	100	140x110	105x80	13.5x11	1100	70	275	245	30	600
AY4307 DDR 250 Y	250	50	120	140x110	105x80	13.5x11	1300	40	320	265	45	300
AY4307 DDR 250 M	250	50	120	140x110	105x80	13.5x11	1300	60	320	273	47	450
AY4307 DDR 250 K	250	50	120	140x110	105x80	13.5x11	1300	100	320	280	40	750
AY4307 DDR 250 S	250	50	120	140x110	105x80	13.5x11	1300	120	320	287	33	1000



DOR

DÖKÜM KASNAK ÜZERİ DÖKME POLİÜRETAN KAPLAMA RULMANLI





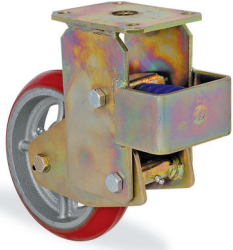

KOD NO	 mm	 mm	 mm	 mm	 mm	 mm	MAKSİMUM TAŞIMA KAPASİTESİ kg	ÖN GERME KUVVETİ kg	H2 TOPLAM YÜKSEKLİK mm	H1 YÜKLÜ TOPLAM YÜKSEKLİK mm	L YAY YOLU mm	YAYIN SON KUVVETİ kg
AY4307 DOR 200 Y	200	50	100	140x110	105x80	13.5x11	1000	30	275	223	52	200
AY4307 DOR 200 M	200	50	100	140x110	105x80	13.5x11	1000	40	275	230	45	300
AY4307 DOR 200 K	200	50	100	140x110	105x80	13.5x11	1000	60	275	237	38	450
AY4307 DOR 200 S	200	50	100	140x110	105x80	13.5x11	1000	70	275	245	30	600

AY4307 Serisi (Amortisörlü)



D2OR





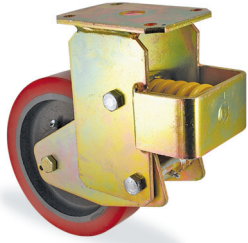

DÖKÜM KASNAK ÜZERİ OVAL DÖKME POLİÜRETAN KAPLAMA RULMANLI

KOD NO	 mm	 mm	 mm	 mm	 mm	 mm	MAKSİMUM TAŞIMA KAPASİTESİ kg	ÖN GERME KUVVETİ kg	H2 TOPLAM YÜKSEKLİK mm	H1 YÜKLÜ TOPLAM YÜKSEKLİK mm	L YAY YOLU mm	YAYIN SON KUVVETİ kg
AY4307 D2OR 200 Y	200	50	100	140x110	105x80	13.5x11	1000	30	275	223	52	200
AY4307 D2OR 200 M	200	50	100	140x110	105x80	13.5x11	1000	40	275	230	45	300
AY4307 D2OR 200 K	200	50	100	140x110	105x80	13.5x11	1000	60	275	237	38	450
AY4307 D2OR 200 S	200	50	100	140x110	105x80	13.5x11	1000	70	275	245	30	600
AY4307 D2OR 250 Y	250	50	120	140x110	105x80	13.5x11	1350	40	320	265	45	300
AY4307 D2OR 250 M	250	50	120	140x110	105x80	13.5x11	1350	60	320	273	47	450
AY4307 D2OR 250 K	250	50	120	140x110	105x80	13.5x11	1350	100	320	280	40	750
AY4307 D2OR 250 S	250	50	120	140x110	105x80	13.5x11	1350	120	320	287	33	1000



KOR





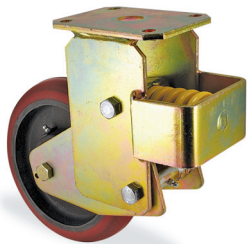

KAMALON KASNAK ÜZERİ DÖKME POLİÜRETAN KAPLAMA RULMANLI

KOD NO	 mm	 mm	 mm	 mm	 mm	 mm	MAKSİMUM TAŞIMA KAPASİTESİ kg	ÖN GERME KUVVETİ kg	H2 TOPLAM YÜKSEKLİK mm	H1 YÜKLÜ TOPLAM YÜKSEKLİK mm	L YAY YOLU mm	YAYIN SON KUVVETİ kg
AY4307 KOR 160 Y	160	50	100	140x110	105x80	13.5x11	800	30	255	203	52	200
AY4307 KOR 160 M	160	50	100	140x110	105x80	13.5x11	800	40	255	205	45	300
AY4307 KOR 160 K	160	50	100	140x110	105x80	13.5x11	800	60	255	217	38	450
AY4307 KOR 160 S	160	50	100	140x110	105x80	13.5x11	800	70	255	225	30	600
AY4307 KOR 200 Y	200	50	100	140x110	105x80	13.5x11	1000	30	275	223	52	200
AY4307 KOR 200 M	200	50	100	140x110	105x80	13.5x11	1000	40	275	230	45	300
AY4307 KOR 200 K	200	50	100	140x110	105x80	13.5x11	1000	60	275	237	38	450
AY4307 KOR 200 S	200	50	100	140x110	105x80	13.5x11	1000	70	275	245	30	600
AY4307 KOR 250 Y	250	50	120	140x110	105x80	13.5x11	1200	40	320	265	45	300
AY4307 KOR 250 M	250	50	120	140x110	105x80	13.5x11	1200	60	320	273	47	450
AY4307 KOR 250 K	250	50	120	140x110	105x80	13.5x11	1200	100	320	280	40	750
AY4307 KOR 250 S	250	50	120	140x110	105x80	13.5x11	1200	120	320	287	33	1000



K2OR







KAMALON KASNAK ÜZERİ OVAL DÖKME POLİÜRETAN KAPLAMA RULMANLI

KOD NO	 mm	 mm	 mm	 mm	 mm	 mm	MAKSİMUM TAŞIMA KAPASİTESİ kg	ÖN GERME KUVVETİ kg	H2 TOPLAM YÜKSEKLİK mm	H1 YÜKLÜ TOPLAM YÜKSEKLİK mm	L YAY YOLU mm	YAYIN SON KUVVETİ kg
AY4307 K2OR 160 Y	160	50	100	140x110	105x80	13.5x11	800	30	255	203	52	200
AY4307 K2OR 160 M	160	50	100	140x110	105x80	13.5x11	800	40	255	205	45	300
AY4307 K2OR 160 K	160	50	100	140x110	105x80	13.5x11	800	60	255	217	38	450
AY4307 K2OR 160 S	160	50	100	140x110	105x80	13.5x11	800	70	255	225	30	600
AY4307 K2OR 200 Y	200	50	100	140x110	105x80	13.5x11	1000	30	275	223	52	200
AY4307 K2OR 200 M	200	50	100	140x110	105x80	13.5x11	1000	40	275	230	45	300
AY4307 K2OR 200 K	200	50	100	140x110	105x80	13.5x11	1000	60	275	237	38	450
AY4307 K2OR 200 S	200	50	100	140x110	105x80	13.5x11	1000	70	275	245	30	600
AY4307 K2OR 250 Y	250	50	120	140x110	105x80	13.5x11	1200	40	320	265	45	300
AY4307 K2OR 250 M	250	50	120	140x110	105x80	13.5x11	1200	60	320	273	47	450
AY4307 K2OR 250 K	250	50	120	140x110	105x80	13.5x11	1200	100	320	280	40	750
AY4307 K2OR 250 S	250	50	120	140x110	105x80	13.5x11	1200	120	320	287	33	1000



DYZ





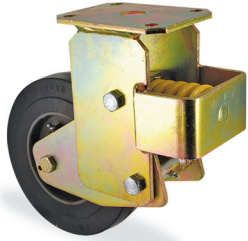

DÖKÜM KASNAK ÜZERİ VULKANİZE LASTİK KAPLAMA RULMANLI

KOD NO	 mm	 mm	 mm	 mm	 mm	 mm	MAKSİMUM TAŞIMA KAPASİTESİ kg	ÖN GERME KUVVETİ kg	H2 TOPLAM YÜKSEKLİK mm	H1 YÜKLÜ TOPLAM YÜKSEKLİK mm	L YAY YOLU mm	YAYIN SON KUVVETİ kg
AY4307 DYZ 200 Y	200	50	100	140x110	105x80	13.5x11	350	30	275	223	52	200
AY4307 DYZ 200 M	200	50	100	140x110	105x80	13.5x11	350	40	275	230	45	300
AY4307 DYZ 200 K	200	50	100	140x110	105x80	13.5x11	350	60	275	237	38	450
AY4307 DYZ 200 S	200	50	100	140x110	105x80	13.5x11	350	70	275	245	30	600



KYR





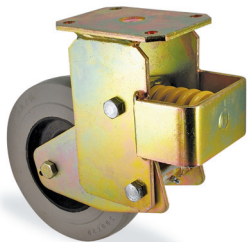

KAMALON KASNAK ÜZERİ VULKANİZE SİYAH LASTİK KAPLAMA RULMANLI

KOD NO	 mm	 mm	 mm	 mm	 mm	 mm	MAKSİMUM TAŞIMA KAPASİTESİ kg	ÖN GERME KUVVETİ kg	H2 TOPLAM YÜKSEKLİK mm	H1 YÜKLÜ TOPLAM YÜKSEKLİK mm	L YAY YOLU mm	YAYIN SON KUVVETİ kg
AY4307 KYR 160 Y	160	50	100	140x110	105x80	13.5x11	240	30	255	203	52	200
AY4307 KYR 160 M	160	50	100	140x110	105x80	13.5x11	240	40	255	205	45	300
AY4307 KYR 160 K	160	50	100	140x110	105x80	13.5x11	240	60	255	217	38	450
AY4307 KYR 160 S	160	50	100	140x110	105x80	13.5x11	240	70	255	225	30	600
AY4307 KYR 200 Y	200	50	100	140x110	105x80	13.5x11	350	30	275	223	52	200
AY4307 KYR 200 M	200	50	100	140x110	105x80	13.5x11	350	40	275	230	45	300
AY4307 KYR 200 K	200	50	100	140x110	105x80	13.5x11	350	60	275	237	38	450
AY4307 KYR 200 S	200	50	100	140x110	105x80	13.5x11	350	70	275	245	30	600
AY4307 KYR 250 Y	250	50	120	140x110	105x80	13.5x11	500	40	320	265	45	300
AY4307 KYR 250 M	250	50	120	140x110	105x80	13.5x11	500	60	320	273	47	450
AY4307 KYR 250 K	250	50	120	140x110	105x80	13.5x11	500	100	320	280	40	750
AY4307 KYR 250 S	250	50	120	140x110	105x80	13.5x11	500	120	320	287	33	1000



KER

KAMALON KASNAK ÜZERİ VULKANİZE GRİ LASTİK KAPLAMA RULMANLI





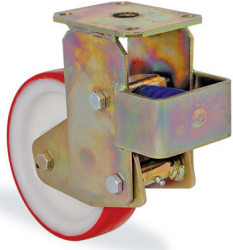

KOD NO	 mm	 mm	 mm	 mm	 mm	 mm	MAKSİMUM TAŞIMA KAPASİTESİ kg	ÖN GERME KUVVETİ kg	H2 TOPLAM YÜKSEKLİK mm	H1 YÜKLÜ TOPLAM YÜKSEKLİK mm	L YAY YOLU mm	YAYIN SON KUVVETİ kg
AY4307 KER 160 Y	160	50	100	140x110	105x80	13.5x11	240	30	255	203	52	200
AY4307 KER 160 M	160	50	100	140x110	105x80	13.5x11	240	40	255	205	45	300
AY4307 KER 160 K	160	50	100	140x110	105x80	13.5x11	240	60	255	217	38	450
AY4307 KER 160 S	160	50	100	140x110	105x80	13.5x11	240	70	255	225	30	600
AY4307 KER 200 Y	200	50	100	140x110	105x80	13.5x11	350	30	275	223	52	200
AY4307 KER 200 M	200	50	100	140x110	105x80	13.5x11	350	40	275	230	45	300
AY4307 KER 200 K	200	50	100	140x110	105x80	13.5x11	350	60	275	237	38	450
AY4307 KER 200 S	200	50	100	140x110	105x80	13.5x11	350	70	275	245	30	600
AY4307 KER 250 Y	250	50	120	140x110	105x80	13.5x11	500	40	320	265	45	300
AY4307 KER 250 M	250	50	120	140x110	105x80	13.5x11	500	60	320	273	47	450
AY4307 KER 250 K	250	50	120	140x110	105x80	13.5x11	500	100	320	280	40	750
AY4307 KER 250 S	250	50	120	140x110	105x80	13.5x11	500	120	320	287	33	1000

AY4307 Serisi (Amortisörlü)



PUR





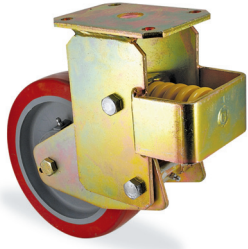

POLİAMİD KASNAK ÜZERİ POLİÜRETAN KAPLAMA RULMANLI

KOD NO	 mm	 mm	 mm	 mm	 mm	 mm	MAKSİMUM TAŞIMA KAPASİTESİ kg	ÖN GERME KUVVETİ kg	H2 TOPLAM YÜKSEKLİK mm	H1 YÜKLÜ TOPLAM YÜKSEKLİK mm	L YAY YOLU mm	YAYIN SON KUVVETİ kg
AY4307 PUR 200 Y	200	50	100	140x110	105x80	13.5x11	600	30	275	223	52	200
AY4307 PUR 200 M	200	50	100	140x110	105x80	13.5x11	600	40	275	230	45	300
AY4307 PUR 200 K	200	50	100	140x110	105x80	13.5x11	600	60	275	237	38	450
AY4307 PUR 200 S	200	50	100	140x110	105x80	13.5x11	600	70	275	245	30	600



KUR





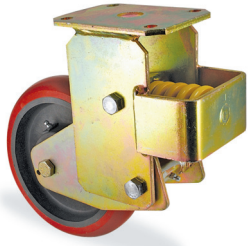

KAMALON KASNAK ÜZERİ ENJEKSİYON POLİÜRETAN KAPLAMA RULMANLI

KOD NO	 mm	 mm	 mm	 mm	 mm	 mm	MAKSİMUM TAŞIMA KAPASİTESİ kg	ÖN GERME KUVVETİ kg	H2 TOPLAM YÜKSEKLİK mm	H1 YÜKLÜ TOPLAM YÜKSEKLİK mm	L YAY YOLU mm	YAYIN SON KUVVETİ kg
AY4307 KUR 160 Y	160	50	100	140x110	105x80	13.5x11	650	30	255	203	52	200
AY4307 KUR 160 M	160	50	100	140x110	105x80	13.5x11	650	40	255	205	45	300
AY4307 KUR 160 K	160	50	100	140x110	105x80	13.5x11	650	60	255	217	38	450
AY4307 KUR 160 S	160	50	100	140x110	105x80	13.5x11	650	70	255	225	30	600
AY4307 KUR 200 Y	200	50	100	140x110	105x80	13.5x11	800	30	275	223	52	200
AY4307 KUR 200 M	200	50	100	140x110	105x80	13.5x11	800	40	275	230	45	300
AY4307 KUR 200 K	200	50	100	140x110	105x80	13.5x11	800	60	275	237	38	450
AY4307 KUR 200 S	200	50	100	140x110	105x80	13.5x11	800	70	275	245	30	600



K2UR





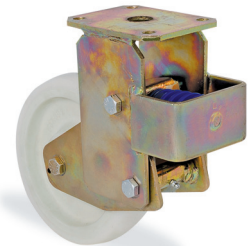

KAMALON KASNAK ÜZERİ OVAL ENJEKSİYON POLİÜRETAN KAPLAMA RULMANLI

KOD NO	 mm	 mm	 mm	 mm	 mm	 mm	MAKSİMUM TAŞIMA KAPASİTESİ kg	ÖN GERME KUVVETİ kg	H2 TOPLAM YÜKSEKLİK mm	H1 YÜKLÜ TOPLAM YÜKSEKLİK mm	L YAY YOLU mm	YAYIN SON KUVVETİ kg
AY4307 K2UR 160 Y	160	50	100	140x110	105x80	13.5x11	650	30	255	203	52	200
AY4307 K2UR 160 M	160	50	100	140x110	105x80	13.5x11	650	40	255	205	45	300
AY4307 K2UR 160 K	160	50	100	140x110	105x80	13.5x11	650	60	255	217	38	450
AY4307 K2UR 160 S	160	50	100	140x110	105x80	13.5x11	650	70	255	225	30	600
AY4307 K2UR 200 Y	200	50	100	140x110	105x80	13.5x11	800	30	275	223	52	200
AY4307 K2UR 200 M	200	50	100	140x110	105x80	13.5x11	800	40	275	230	45	300
AY4307 K2UR 200 K	200	50	100	140x110	105x80	13.5x11	800	60	275	237	38	450
AY4307 K2UR 200 S	200	50	100	140x110	105x80	13.5x11	800	70	275	245	30	600



RPR





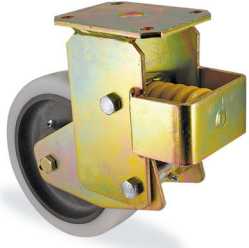

AĞIR TİP POLİAMİD TEKER RULMANLI

KOD NO	 mm	 mm	 mm	 mm	 mm	 mm	MAKSİMUM TAŞIMA KAPASİTESİ kg	ÖN GERME KUVVETİ kg	H2 TOPLAM YÜKSEKLİK mm	H1 YÜKLÜ TOPLAM YÜKSEKLİK mm	L YAY YOLU mm	YAYIN SON KUVVETİ kg
AY4307 RPR 200 Y	200	50	100	140x110	105x80	13.5x11	900	30	275	223	52	200
AY4307 RPR 200 M	200	50	100	140x110	105x80	13.5x11	900	40	275	230	45	300
AY4307 RPR 200 K	200	50	100	140x110	105x80	13.5x11	900	60	275	237	38	450
AY4307 RPR 200 S	200	50	100	140x110	105x80	13.5x11	900	70	275	245	30	600



KPR





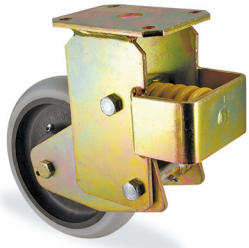

KAMALON KASNAK ÜZERİ POLİAMİD KAPLAMA RULMANLI

KOD NO	 mm	 mm	 mm	 mm	 mm	 mm	MAKSİMUM TAŞIMA KAPASİTESİ kg	ÖN GERME KUVVETİ kg	H2 TOPLAM YÜKSEKLİK mm	H1 YÜKLÜ TOPLAM YÜKSEKLİK mm	L YAY YOLU mm	YAYIN SON KUVVETİ kg
AY4307 KPR 160 Y	160	50	100	140x110	105x80	13.5x11	800	30	255	203	52	200
AY4307 KPR 160 M	160	50	100	140x110	105x80	13.5x11	800	40	255	205	45	300
AY4307 KPR 160 K	160	50	100	140x110	105x80	13.5x11	800	60	255	217	38	450
AY4307 KPR 160 S	160	50	100	140x110	105x80	13.5x11	800	70	255	225	30	600
AY4307 KPR 200 Y	200	50	100	140x110	105x80	13.5x11	1000	30	275	223	52	200
AY4307 KPR 200 M	200	50	100	140x110	105x80	13.5x11	1000	40	275	230	45	300
AY4307 KPR 200 K	200	50	100	140x110	105x80	13.5x11	1000	60	275	237	38	450
AY4307 KPR 200 S	200	50	100	140x110	105x80	13.5x11	1000	70	275	245	30	600



K2PR

KAMALON KASNAK ÜZERİ OVAL POLİAMİD KAPLAMA RULMANLI

KOD NO	 mm	 mm	 mm	 mm	 mm	 mm	MAKSİMUM TAŞIMA KAPASİTESİ kg	ÖN GERME KUVVETİ kg	H2 TOPLAM YÜKSEKLİK mm	H1 YÜKLÜ TOPLAM YÜKSEKLİK mm	L YAY YOLU mm	YAYIN SON KUVVETİ kg
AY4307 K2PR 160 Y	160	50	100	140x110	105x80	13.5x11	800	30	255	203	52	200
AY4307 K2PR 160 M	160	50	100	140x110	105x80	13.5x11	800	40	255	205	45	300
AY4307 K2PR 160 K	160	50	100	140x110	105x80	13.5x11	800	60	255	217	38	450
AY4307 K2PR 160 S	160	50	100	140x110	105x80	13.5x11	800	70	255	225	30	600
AY4307 K2PR 200 Y	200	50	100	140x110	105x80	13.5x11	1000	30	275	223	52	200
AY4307 K2PR 200 M	200	50	100	140x110	105x80	13.5x11	1000	40	275	230	45	300
AY4307 K2PR 200 K	200	50	100	140x110	105x80	13.5x11	1000	60	275	237	38	450
AY4307 K2PR 200 S	200	50	100	140x110	105x80	13.5x11	1000	70	275	245	30	600

- A:** OYNAK TABLA
B: TABLA ÇANAĞI
C: TABLA BAĞLANTI CİVATASI
D: BÜTE RULMAN
E: MAŞA ÇANAĞI
F: OYNAK RULET MAŞASI
G: GRESÖRLÜK
H: BİLYA MUHAFAZA TOZLUĞU
I: KÜRESEL METAL TANE BİLYALAR
J: CK60 MALZEMEDEN SERTLEŞTİRİLMİŞ BİLYA YATAĞI
K: DÖVME ALT BİLYA ÇANAĞI
L: YARIKLI PİM

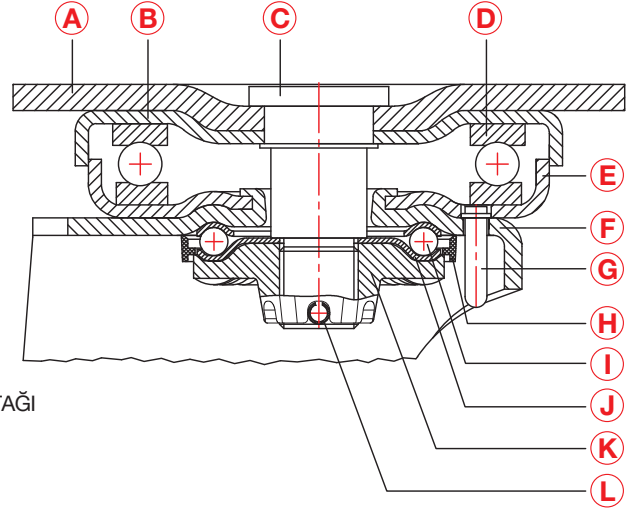
BBC
ISIYA DAYANIKLI BAKALİT TEKER PİRİNÇ BURÇLU (+250°C)

KOD NO	mm	mm	mm	mm	mm	mm	mm	kg
4402 BBC 100	100	35	150	46.5	140x110	105x80	13.5x11	150
4402 BBC 125	125	40	181	48	140x110	105x80	13.5x11	300
4402 BBC 150	150	45	215	52	140x110	105x80	13.5x11	450
4402 BBC 200	200	50	258	58	140x110	105x80	13.5x11	600

CTB
GÜÇLENDİRİLMİŞ POLİAMİD KASNAK ÜZERİ TERMOELASTİK GRİ LASTİK KAPLAMA BURÇLU

KOD NO	mm	mm	mm	mm	mm	mm	mm	kg
4402 CTB 100	100	35	150	46.5	140x110	105x80	13.5x11	120
4402 CTB 125	125	40	181	48	140x110	105x80	13.5x11	150
4402 CTB 150	150	45	215	52	140x110	105x80	13.5x11	180
4402 CTB 200	200	50	258	58	140x110	105x80	13.5x11	250











CTB		GÜÇLENDİRİLMİŞ POLİAMİD KASNAK ÜZERİ TERMOELASTİK GRİ LASTİK KAPLAMA BURÇLU							
KOD NO									
	mm	mm	mm	mm	mm	mm	mm	mm	kg
4402 CTB 100 F18	100	35	150	50.5	163	140x110	105x80	13.5x11	120
4402 CTB 125 F18	125	40	181	51	166	140x110	105x80	13.5x11	150
4402 CTB 150 F18	150	45	215	56.5	165	140x110	105x80	13.5x11	180
4402 CTB 200 F18	200	50	258	60	162	140x110	105x80	13.5x11	250



YÖN KİLİTLİ

CTB		GÜÇLENDİRİLMİŞ POLİAMİD KASNAK ÜZERİ TERMOELASTİK GRİ LASTİK KAPLAMA BURÇLU							
KOD NO									
	mm	mm	mm	mm	mm	mm	mm	mm	kg
4402 CTB 100 F17	100	35	150	46.5	145	140x110	105x80	13.5x11	120
4402 CTB 125 F17	125	40	181	48	145	140x110	105x80	13.5x11	150
4402 CTB 150 F17	150	45	215	52	145	140x110	105x80	13.5x11	180
4402 CTB 200 F17	200	50	258	58	145	140x110	105x80	13.5x11	250







CTR		GÜÇLENDİRİLMİŞ POLİAMİD KASNAK ÜZERİ TERMOELASTİK GRİ LASTİK KAPLAMA RULMANLI							
KOD NO									
	mm	mm	mm	mm	mm	mm	mm	mm	kg
4402 CTR 100	100	35	150	46.5	140x110	105x80	13.5x11	120	
4402 CTR 125	125	40	181	48	140x110	105x80	13.5x11	150	
4402 CTR 150	150	45	215	52	140x110	105x80	13.5x11	180	
4402 CTR 200	200	50	258	58	140x110	105x80	13.5x11	250	









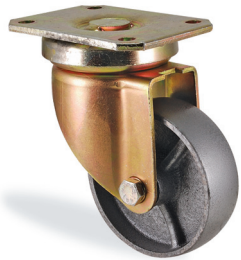

CTR		GÜÇLENDİRİLMİŞ POLİAMİD KASNAK ÜZERİ TERMOELASTİK GRİ LASTİK KAPLAMA RULMANLI							
KOD NO									
	mm	mm	mm	mm	mm	mm	mm	mm	kg
4402 CTR 100 F18	100	35	150	50.5	163	140x110	105x80	13.5x11	120
4402 CTR 125 F18	125	40	181	51	166	140x110	105x80	13.5x11	150
4402 CTR 150 F18	150	45	215	56.5	165	140x110	105x80	13.5x11	180
4402 CTR 200 F18	200	50	258	60	162	140x110	105x80	13.5x11	250











YÖN KİLİTLİ

CTR		GÜÇLENDİRİLMİŞ POLİAMİD KASNAK ÜZERİ TERMOELASTİK GRİ LASTİK KAPLAMA RULMANLI							
KOD NO									
	mm	mm	mm	mm	mm	mm	mm	mm	kg
4402 CTR 100 F17	100	35	150	46.5	145	140x110	105x80	13.5x11	120
4402 CTR 125 F17	125	40	181	48	145	140x110	105x80	13.5x11	150
4402 CTR 150 F17	150	45	215	52	145	140x110	105x80	13.5x11	180
4402 CTR 200 F17	200	50	258	58	145	140x110	105x80	13.5x11	250









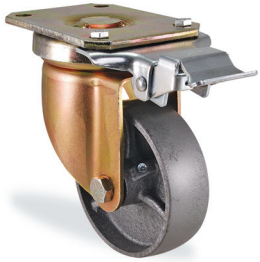

DDB		DÖKÜM TEKER BURÇLU							
KOD NO									
	mm	mm	mm	mm	mm	mm	mm	mm	kg
4402 DDB 100	100	35	150	46.5	140x110	105x80	13.5x11	450	
4402 DDB 125	125	40	181	48	140x110	105x80	13.5x11	500	
4402 DDB 150	150	45	215	52	140x110	105x80	13.5x11	800	
4402 DDB 200	200	50	258	58	140x110	105x80	13.5x11	1100	









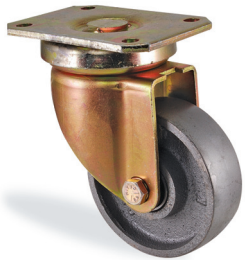

DDB		DÖKÜM TEKER BURÇLU							
KOD NO									
	mm	mm	mm	mm	mm	mm	mm	mm	kg
4402 DDB 100 F18	100	35	150	50.5	163	140x110	105x80	13.5x11	450
4402 DDB 125 F18	125	40	181	51	166	140x110	105x80	13.5x11	500
4402 DDB 150 F18	150	45	215	56.5	165	140x110	105x80	13.5x11	800
4402 DDB 200 F18	200	50	258	60	162	140x110	105x80	13.5x11	1100











YÖN KİLİTLİ

DDB		DÖKÜM TEKER BURÇLU							
KOD NO									
	mm	mm	mm	mm	mm	mm	mm	mm	kg
4402 DDB 100 F17	100	35	150	46.5	145	140x110	105x80	13.5x11	450
4402 DDB 125 F17	125	40	181	48	145	140x110	105x80	13.5x11	500
4402 DDB 150 F17	150	45	215	52	145	140x110	105x80	13.5x11	800
4402 DDB 200 F17	200	50	258	58	145	140x110	105x80	13.5x11	1100









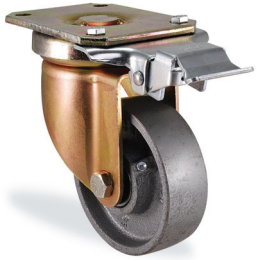

DDR		DÖKÜM TEKER RULMANLI							
KOD NO									
	mm	mm	mm	mm	mm	mm	mm	mm	kg
4402 DDR 100	100	35	150	46.5	140x110	105x80	13.5x11	450	
4402 DDR 125	125	40	181	48	140x110	105x80	13.5x11	500	
4402 DDR 150	150	45	215	52	140x110	105x80	13.5x11	800	
4402 DDR 200	200	50	258	58	140x110	105x80	13.5x11	1100	









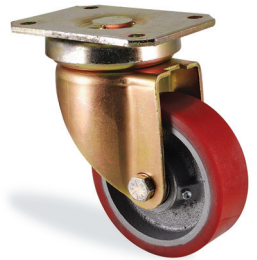

DDR		DÖKÜM TEKER RULMANLI							
KOD NO									
	mm	mm	mm	mm	mm	mm	mm	mm	kg
4402 DDR 100 F18	100	35	150	50.5	163	140x110	105x80	13.5x11	450
4402 DDR 125 F18	125	40	181	51	166	140x110	105x80	13.5x11	500
4402 DDR 150 F18	150	45	215	56.5	165	140x110	105x80	13.5x11	800
4402 DDR 200 F18	200	50	258	60	162	140x110	105x80	13.5x11	1100











YÖN KİLİTLİ

DDR		DÖKÜM TEKER RULMANLI							
KOD NO									
	mm	mm	mm	mm	mm	mm	mm	mm	kg
4402 DDR 100 F17	100	35	150	46.5	145	140x110	105x80	13.5x11	450
4402 DDR 125 F17	125	40	181	48	145	140x110	105x80	13.5x11	500
4402 DDR 150 F17	150	45	215	52	145	140x110	105x80	13.5x11	800
4402 DDR 200 F17	200	50	258	58	145	140x110	105x80	13.5x11	1100











DOR		DÖKÜM ÜZERİ DÖKME POLİÜRETAN KAPLAMA RULMANLI							
KOD NO									
	mm	mm	mm	mm	mm	mm	mm	mm	kg
4402 DOR 100	100	35	150	46.5	140x110	105x80	13.5x11	350	
4402 DOR 125	125	40	181	48	140x110	105x80	13.5x11	450	
4402 DOR 150	150	45	215	52	140x110	105x80	13.5x11	700	
4402 DOR 200	200	50	258	58	140x110	105x80	13.5x11	1000	











DOR		DÖKÜM ÜZERİ DÖKME POLİÜRETAN KAPLAMA RULMANLI							
KOD NO									
	mm	mm	mm	mm	mm	mm	mm	mm	kg
4402 DOR 100 F18	100	35	150	50.5	163	140x110	105x80	13.5x11	350
4402 DOR 125 F18	125	40	181	51	166	140x110	105x80	13.5x11	450
4402 DOR 150 F18	150	45	215	56.5	165	140x110	105x80	13.5x11	700
4402 DOR 200 F18	200	50	258	60	162	140x110	105x80	13.5x11	1000











YÖN KİLİTLİ

DOR		DÖKÜM ÜZERİ DÖKME POLİÜRETAN KAPLAMA RULMANLI							
KOD NO									
	mm	mm	mm	mm	mm	mm	mm	mm	kg
4402 DOR 100 F17	100	35	150	46.5	145	140x110	105x80	13.5x11	350
4402 DOR 125 F17	125	40	181	48	145	140x110	105x80	13.5x11	450
4402 DOR 150 F17	150	45	215	52	145	140x110	105x80	13.5x11	700
4402 DOR 200 F17	200	50	258	58	145	140x110	105x80	13.5x11	1000









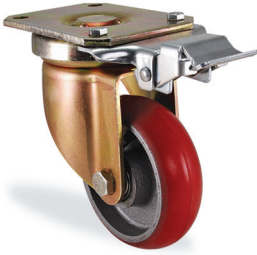

D2OR		DÖKÜM ÜZERİ OVAL DÖKME POLİÜRETAN KAPLAMA RULMANLI							
KOD NO									
	mm	mm	mm	mm	mm	mm	mm	mm	kg
4402 D2OR 100	100	35	150	46.5	140x110	105x80	13.5x11		350
4402 D2OR 125	125	40	181	48	140x110	105x80	13.5x11		450
4402 D2OR 150	150	45	215	52	140x110	105x80	13.5x11		700
4402 D2OR 200	200	50	258	58	140x110	105x80	13.5x11		1000









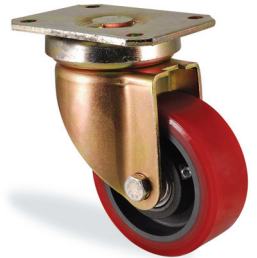

D2OR
DÖKÜM ÜZERİ OVAL DÖKME POLİÜRETAN KAPLAMA RULMANLI

KOD NO	 mm	 mm	 mm	 mm	 mm	 mm	 mm	 mm	 kg
4402 D2OR 100 F18	100	35	150	50.5	163	140x110	105x80	13.5x11	350
4402 D2OR 125 F18	125	40	181	51	166	140x110	105x80	13.5x11	450
4402 D2OR 150 F18	150	45	215	56.5	165	140x110	105x80	13.5x11	700
4402 D2OR 200 F18	200	50	258	60	162	140x110	105x80	13.5x11	1000











YÖN KİLİTLİ
D2OR
DÖKÜM ÜZERİ OVAL DÖKME POLİÜRETAN KAPLAMA RULMANLI

KOD NO	 mm	 mm	 mm	 mm	 mm	 mm	 mm	 mm	 kg
4402 D2OR 100 F17	100	35	150	46.5	145	140x110	105x80	13.5x11	350
4402 D2OR 125 F17	125	40	181	48	145	140x110	105x80	13.5x11	450
4402 D2OR 150 F17	150	45	215	52	145	140x110	105x80	13.5x11	700
4402 D2OR 200 F17	200	50	258	58	145	140x110	105x80	13.5x11	1000

KOR
KAMALON ÜZERİ DÖKME POLİÜRETAN KAPLAMA RULMANLI

KOD NO	 mm	 mm	 mm	 mm	 mm	 mm	 mm	 mm	 kg
4402 KOR 100	100	40	150	46.5	140x110	105x80	105x80	13.5x11	350
4402 KOR 125	125	50	181	48	140x110	105x80	105x80	13.5x11	450
4402 KOR 150	150	50	215	52	140x110	105x80	105x80	13.5x11	700
4402 KOR 160	160	50	208	61	140x110	105x80	105x80	13.5x11	800
4402 KOR 200	200	50	258	58	140x110	105x80	105x80	13.5x11	1000





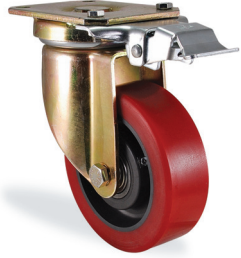





KOR		KAMALON ÜZERİ DÖKME POLİÜRETAN KAPLAMA RULMANLI							
KOD NO									
	mm	mm	mm	mm	mm	mm	mm	mm	kg
4402 KOR 100 F18	100	40	150	50.5	163	140x110	105x80	13.5x11	350
4402 KOR 125 F18	125	50	181	51	166	140x110	105x80	13.5x11	450
4402 KOR 150 F18	150	50	215	56.5	165	140x110	105x80	13.5x11	700
4402 KOR 160 F18	160	50	208	58	161	140x110	105x80	13.5x11	800
4402 KOR 200 F18	200	50	258	60	162	140x110	105x80	13.5x11	1000











YÖN KİLİTLİ

KOR		KAMALON ÜZERİ DÖKME POLİÜRETAN KAPLAMA RULMANLI							
KOD NO									
	mm	mm	mm	mm	mm	mm	mm	mm	kg
4402 KOR 100 F17	100	40	150	46.5	145	140x110	105x80	13.5x11	350
4402 KOR 125 F17	125	50	181	48	145	140x110	105x80	13.5x11	450
4402 KOR 150 F17	150	50	215	52	145	140x110	105x80	13.5x11	700
4402 KOR 160 F17	160	50	208	61	145	140x110	105x80	13.5x11	800
4402 KOR 200 F17	200	50	258	58	145	140x110	105x80	13.5x11	1000











K2OR		KAMALON ÜZERİ OVAL DÖKME POLİÜRETAN KAPLAMA RULMANLI							
KOD NO									
	mm	mm	mm	mm	mm	mm	mm	mm	kg
4402 K2OR 100	100	40	150	46.5	140x110	105x80	13.5x11	350	
4402 K2OR 125	125	50	181	48	140x110	105x80	13.5x11	450	
4402 K2OR 150	150	50	215	52	140x110	105x80	13.5x11	700	
4402 K2OR 160	160	50	208	61	140x110	105x80	13.5x11	800	
4402 K2OR 200	200	50	258	58	140x110	105x80	13.5x11	1000	











K2OR
KAMALON ÜZERİ OVAL DÖKME POLİÜRETAN KAPLAMA RULMANLI

KOD NO	 mm	 mm	 mm	 mm	 mm	 mm	 mm	 mm	 kg
4402 K2OR 100 F18	100	40	150	50.5	163	140x110	105x80	13.5x11	350
4402 K2OR 125 F18	125	50	181	51	166	140x110	105x80	13.5x11	450
4402 K2OR 150 F18	150	50	215	56.5	165	140x110	105x80	13.5x11	700
4402 K2OR 160 F18	160	50	208	58	161	140x110	105x80	13.5x11	800
4402 K2OR 200 F18	200	50	258	60	162	140x110	105x80	13.5x11	1000











YÖN KİLİTLİ
K2OR
KAMALON ÜZERİ OVAL DÖKME POLİÜRETAN KAPLAMA RULMANLI

KOD NO	 mm	 mm	 mm	 mm	 mm	 mm	 mm	 mm	 kg
4402 K2OR 100 F17	100	40	150	46.5	145	140x110	105x80	13.5x11	350
4402 K2OR 125 F17	125	50	181	48	145	140x110	105x80	13.5x11	450
4402 K2OR 150 F17	150	50	215	52	145	140x110	105x80	13.5x11	700
4402 K2OR 160 F17	160	50	208	61	145	140x110	105x80	13.5x11	800
4402 K2OR 200 F17	200	50	258	58	145	140x110	105x80	13.5x11	1000











DYR
DÖKÜM ÜZERİ VULKANİZE LASTİK KAPLAMA RULMANLI

KOD NO	 mm	 mm	 mm	 mm	 mm	 mm	 mm	 mm	 kg
4402 DYR 100	100	35	150	46.5	140x110	105x80	105x80	13.5x11	140
4402 DYR 125	125	40	181	48	140x110	105x80	105x80	13.5x11	180
4402 DYR 150	150	45	215	52	140x110	105x80	105x80	13.5x11	200
4402 DYR 200	200	50	258	58	140x110	105x80	105x80	13.5x11	350











DYR DÖKÜM ÜZERİ VULKANİZE LASTİK KAPLAMA RULMANLI

KOD NO	 mm	 mm	 mm	 mm	 mm	 mm	 mm	 mm	 kg
4402 DYR 100 F18	100	35	150	50.5	163	140x110	105x80	13.5x11	140
4402 DYR 125 F18	125	40	181	51	166	140x110	105x80	13.5x11	180
4402 DYR 150 F18	150	45	215	56.5	165	140x110	105x80	13.5x11	200
4402 DYR 200 F18	200	50	258	60	162	140x110	105x80	13.5x11	350

YÖN KİLİTLİ
DYR DÖKÜM ÜZERİ VULKANİZE LASTİK KAPLAMA RULMANLI

KOD NO	 mm	 mm	 mm	 mm	 mm	 mm	 mm	 mm	 kg
4402 DYR 100 F17	100	35	150	46.5	145	140x110	105x80	13.5x11	140
4402 DYR 125 F17	125	40	181	48	145	140x110	105x80	13.5x11	180
4402 DYR 150 F17	150	45	215	52	145	140x110	105x80	13.5x11	200
4402 DYR 200 F17	200	50	258	58	145	140x110	105x80	13.5x11	350

KYR KAMALON KASNAK ÜZERİ VULKANİZE SİYAH LASTİK KAPLAMA RULMANLI

KOD NO	 mm	 mm	 mm	 mm	 mm	 mm	 mm	 mm	 kg
4402 KYR 100	100	40	150	46.5	140x110	105x80	13.5x11	140	
4402 KYR 125	125	40	181	48	140x110	105x80	13.5x11	180	
4402 KYR 150	150	45	215	52	140x110	105x80	13.5x11	200	
4402 KYR 160	160	50	208	61	140x110	105x80	13.5x11	240	
4402 KYR 200	200	50	258	58	140x110	105x80	13.5x11	350	



KYR		KAMALON KASNAK ÜZERİ VULKANİZE SİYAH LASTİK KAPLAMA RULMANLI							
KOD NO									
	mm	mm	mm	mm	mm	mm	mm	mm	kg
4402 KYR 100 F18	100	40	150	50.5	163	140x110	105x80	13.5x11	140
4402 KYR 125 F18	125	40	181	51	166	140x110	105x80	13.5x11	180
4402 KYR 150 F18	150	45	215	56.5	165	140x110	105x80	13.5x11	200
4402 KYR 160 F18	160	50	208	58	161	140x110	105x80	13.5x11	240
4402 KYR 200 F18	200	50	258	60	162	140x110	105x80	13.5x11	350

YÖN KİLİTLİ

KYR		KAMALON KASNAK ÜZERİ VULKANİZE SİYAH LASTİK KAPLAMA RULMANLI							
KOD NO									
	mm	mm	mm	mm	mm	mm	mm	mm	kg
4402 KYR 100 F17	100	40	150	46.5	145	140x110	105x80	13.5x11	140
4402 KYR 125 F17	125	40	181	48	145	140x110	105x80	13.5x11	180
4402 KYR 150 F17	150	45	215	52	145	140x110	105x80	13.5x11	200
4402 KYR 160 F17	160	50	208	61	145	140x110	105x80	13.5x11	240
4402 KYR 200 F17	200	50	258	58	145	140x110	105x80	13.5x11	350



KER		KAMALON KASNAK ÜZERİ VULKANİZE GRİ LASTİK KAPLAMA RULMANLI							
KOD NO									
	mm	mm	mm	mm	mm	mm	mm	mm	kg
4402 KER 100	100	40	150	46.5	140x110	105x80	13.5x11	140	
4402 KER 125	125	40	181	48	140x110	105x80	13.5x11	180	
4402 KER 150	150	45	215	52	140x110	105x80	13.5x11	200	
4402 KER 160	160	50	208	61	140x110	105x80	13.5x11	240	
4402 KER 200	200	50	258	58	140x110	105x80	13.5x11	350	









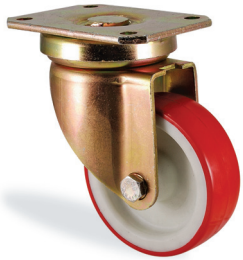

KER		KAMALON KASNAK ÜZERİ VULKANİZE GRİ LASTİK KAPLAMA RULMANLI								
KOD NO										
	mm	mm	mm	mm	mm	mm	mm	mm	mm	kg
4402 KER 100 F18	100	40	150	50.5	163	140x110	105x80	13.5x11		140
4402 KER 125 F18	125	40	181	51	166	140x110	105x80	13.5x11		180
4402 KER 150 F18	150	45	215	56.5	165	140x110	105x80	13.5x11		200
4402 KER 160 F18	160	50	208	58	161	140x110	105x80	13.5x11		240
4402 KER 200 F18	200	50	258	60	162	140x110	105x80	13.5x11		350



YÖN KİLİTLİ

KER		KAMALON KASNAK ÜZERİ VULKANİZE GRİ LASTİK KAPLAMA RULMANLI								
KOD NO										
	mm	mm	mm	mm	mm	mm	mm	mm	mm	kg
4402 KER 100 F17	100	40	150	46.5	145	140x110	105x80	13.5x11		140
4402 KER 125 F17	125	40	181	48	145	140x110	105x80	13.5x11		180
4402 KER 150 F17	150	45	215	52	145	140x110	105x80	13.5x11		200
4402 KER 160 F17	160	50	208	61	145	140x110	105x80	13.5x11		240
4402 KER 200 F17	200	50	258	58	145	140x110	105x80	13.5x11		350



PUB		POLİAMİD KASNAK ÜZERİ POLİÜRETAN KAPLAMA BURÇLU								
KOD NO										
	mm	mm	mm	mm	mm	mm	mm	mm	mm	kg
4402 PUB 100	100	35	150	46.5	140x110	105x80	13.5x11			200
4402 PUB 125	125	40	181	48	140x110	105x80	13.5x11			250
4402 PUB 150	150	45	215	52	140x110	105x80	13.5x11			400
4402 PUB 200	200	50	258	58	140x110	105x80	13.5x11			600





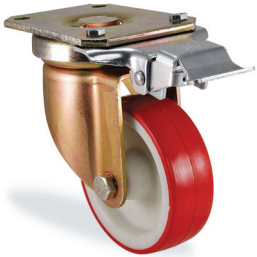

PUB		POLİAMİD KASNAK ÜZERİ POLİÜRETAN KAPLAMA BURÇLU							
KOD NO									
	mm	mm	mm	mm	mm	mm	mm	mm	kg
4402 PUB 100 F18	100	35	150	50.5	163	140x110	105x80	13.5x11	200
4402 PUB 125 F18	125	40	181	51	166	140x110	105x80	13.5x11	250
4402 PUB 150 F18	150	45	215	56.5	165	140x110	105x80	13.5x11	400
4402 PUB 200 F18	200	50	258	60	162	140x110	105x80	13.5x11	600

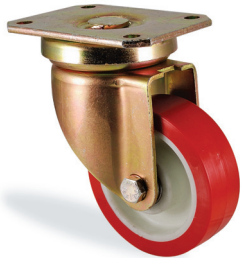
YÖN KİLİTLİ

PUB		POLİAMİD KASNAK ÜZERİ POLİÜRETAN KAPLAMA BURÇLU							
KOD NO									
	mm	mm	mm	mm	mm	mm	mm	mm	kg
4402 PUB 100 F17	100	35	150	46.5	145	140x110	105x80	13.5x11	200
4402 PUB 125 F17	125	40	181	48	145	140x110	105x80	13.5x11	250
4402 PUB 150 F17	150	45	215	52	145	140x110	105x80	13.5x11	400
4402 PUB 200 F17	200	50	258	58	145	140x110	105x80	13.5x11	600



PUR		POLİAMİD KASNAK ÜZERİ POLİÜRETAN KAPLAMA RULMANLI							
KOD NO									
	mm	mm	mm	mm	mm	mm	mm	mm	kg
4402 PUR 100	100	35	150	46.5	140x110	105x80	13.5x11	200	
4402 PUR 125	125	40	181	48	140x110	105x80	13.5x11	250	
4402 PUR 150	150	45	215	52	140x110	105x80	13.5x11	400	
4402 PUR 200	200	50	258	58	140x110	105x80	13.5x11	600	





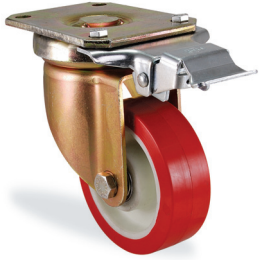





PUR		POLİAMİD KASNAK ÜZERİ POLİÜRETAN KAPLAMA RULMANLI							
KOD NO									
	mm	mm	mm	mm	mm	mm	mm	mm	kg
4402 PUR 100 F18	100	35	150	50.5	163	140x110	105x80	13.5x11	200
4402 PUR 125 F18	125	40	181	51	166	140x110	105x80	13.5x11	250
4402 PUR 150 F18	150	45	215	56.5	165	140x110	105x80	13.5x11	400
4402 PUR 200 F18	200	50	258	60	162	140x110	105x80	13.5x11	600











YÖN KİLİTLİ

PUR		POLİAMİD KASNAK ÜZERİ POLİÜRETAN KAPLAMA RULMANLI							
KOD NO									
	mm	mm	mm	mm	mm	mm	mm	mm	kg
4402 PUR 100 F17	100	35	150	46.5	145	140x110	105x80	13.5x11	200
4402 PUR 125 F17	125	40	181	48	145	140x110	105x80	13.5x11	250
4402 PUR 150 F17	150	45	215	52	145	140x110	105x80	13.5x11	400
4402 PUR 200 F17	200	50	258	58	145	140x110	105x80	13.5x11	600











KUR		KAMALON ÜZERİ ENJEKSİYON POLİÜRETAN KAPLAMA RULMANLI							
KOD NO									
	mm	mm	mm	mm	mm	mm	mm	mm	kg
4402 KUR 100	100	40	150	46.5	140x110	105x80	13.5x11	250	
4402 KUR 125	125	50	181	48	140x110	105x80	13.5x11	300	
4402 KUR 150	150	50	215	52	140x110	105x80	13.5x11	550	
4402 KUR 160	160	50	208	61	140x110	105x80	13.5x11	650	
4402 KUR 200	200	50	258	58	140x110	105x80	13.5x11	800	











KUR		KAMALON ÜZERİ ENJEKSİYON POLİÜRETAN KAPLAMA RULMANLI							
KOD NO									
	mm	mm	mm	mm	mm	mm	mm	mm	kg
4402 KUR 100 F18	100	40	150	50.5	163	140x110	105x80	13.5x11	250
4402 KUR 125 F18	125	50	181	51	166	140x110	105x80	13.5x11	300
4402 KUR 150 F18	150	50	215	56.5	165	140x110	105x80	13.5x11	550
4402 KUR 160 F18	160	50	208	58	161	140x110	105x80	13.5x11	650
4402 KUR 200 F18	200	50	258	60	162	140x110	105x80	13.5x11	800











YÖN KİLİTLİ

KUR		KAMALON ÜZERİ ENJEKSİYON POLİÜRETAN KAPLAMA RULMANLI							
KOD NO									
	mm	mm	mm	mm	mm	mm	mm	mm	kg
4402 KUR 100 F17	100	40	150	46.5	145	140x110	105x80	13.5x11	250
4402 KUR 125 F17	125	50	181	48	145	140x110	105x80	13.5x11	300
4402 KUR 150 F17	150	50	215	52	145	140x110	105x80	13.5x11	550
4402 KUR 160 F17	160	50	208	61	145	140x110	105x80	13.5x11	650
4402 KUR 200 F17	200	50	258	58	145	140x110	105x80	13.5x11	800









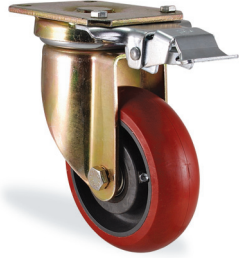

K2UR		KAMALON ÜZERİ OVAL ENJEKSİYON POLİÜRETAN KAPLAMA RULMANLI							
KOD NO									
	mm	mm	mm	mm	mm	mm	mm	mm	kg
4402 K2UR 100	100	40	150	46.5	140x110	105x80	13.5x11	250	
4402 K2UR 125	125	50	181	48	140x110	105x80	13.5x11	300	
4402 K2UR 150	150	50	215	52	140x110	105x80	13.5x11	550	
4402 K2UR 160	160	50	208	61	140x110	105x80	13.5x11	650	
4402 K2UR 200	200	50	258	58	140x110	105x80	13.5x11	800	











K2UR
KAMALON ÜZERİ OVAL ENJEKSİYON POLİÜRETAN KAPLAMA RULMANLI

KOD NO	 mm	 mm	 mm	 mm	 mm	 mm	 mm	 mm	 kg
4402 K2UR 100 F18	100	40	150	50.5	163	140x110	105x80	13.5x11	250
4402 K2UR 125 F18	125	50	181	51	166	140x110	105x80	13.5x11	300
4402 K2UR 150 F18	150	50	215	56.5	165	140x110	105x80	13.5x11	550
4402 K2UR 160 F18	160	50	208	58	161	140x110	105x80	13.5x11	650
4402 K2UR 200 F18	200	50	258	60	162	140x110	105x80	13.5x11	800











YÖN KİLİTLİ
K2UR
KAMALON ÜZERİ OVAL ENJEKSİYON POLİÜRETAN KAPLAMA RULMANLI

KOD NO	 mm	 mm	 mm	 mm	 mm	 mm	 mm	 mm	 kg
4402 K2UR 100 F17	100	40	150	46.5	145	140x110	105x80	13.5x11	250
4402 K2UR 125 F17	125	50	181	48	145	140x110	105x80	13.5x11	300
4402 K2UR 150 F17	150	50	215	52	145	140x110	105x80	13.5x11	550
4402 K2UR 160 F17	160	50	208	61	145	140x110	105x80	13.5x11	650
4402 K2UR 200 F17	200	50	258	58	145	140x110	105x80	13.5x11	800

RMB
AĞIR TİP MOBLEN (PP) TEKER BURÇLU

KOD NO	 mm	 mm	 mm	 mm	 mm	 mm	 mm	 mm	 kg
4402 RMB 100	100	35	150	46.5	140x110	105x80	13.5x11	300	
4402 RMB 125	125	40	181	48	140x110	105x80	13.5x11	400	
4402 RMB 150	150	45	215	52	140x110	105x80	13.5x11	500	
4402 RMB 200	200	50	258	58	140x110	105x80	13.5x11	800	











RMB		AĞIR TİP MOBLEN (PP) TEKER BURÇLU							
KOD NO									
	mm	mm	mm	mm	mm	mm	mm	mm	kg
4402 RMB 100 F18	100	35	150	50.5	163	140x110	105x80	13.5x11	300
4402 RMB 125 F18	125	40	181	51	166	140x110	105x80	13.5x11	400
4402 RMB 150 F18	150	45	215	56.5	165	140x110	105x80	13.5x11	500
4402 RMB 200 F18	200	50	258	60	162	140x110	105x80	13.5x11	800











YÖN KİLİTLİ

RMB		AĞIR TİP MOBLEN (PP) TEKER BURÇLU							
KOD NO									
	mm	mm	mm	mm	mm	mm	mm	mm	kg
4402 RMB 100 F17	100	35	150	46.5	145	140x110	105x80	13.5x11	300
4402 RMB 125 F17	125	40	181	48	145	140x110	105x80	13.5x11	400
4402 RMB 150 F17	150	45	215	52	145	140x110	105x80	13.5x11	500
4402 RMB 200 F17	200	50	258	58	145	140x110	105x80	13.5x11	800











RPB		AĞIR TİP POLİAMİD TEKER BURÇLU							
KOD NO									
	mm	mm	mm	mm	mm	mm	mm	mm	kg
4402 RPB 100	100	35	150	46.5	140x110	105x80	13.5x11	400	
4402 RPB 125	125	40	181	48	140x110	105x80	13.5x11	500	
4402 RPB 150	150	45	215	52	140x110	105x80	13.5x11	600	
4402 RPB 200	200	50	258	58	140x110	105x80	13.5x11	900	











RPB		AĞIR TİP POLİAMİD TEKER BURÇLU							
KOD NO									
	mm	mm	mm	mm	mm	mm	mm	mm	kg
4402 RPB 100 F18	100	35	150	50.5	163	140x110	105x80	13.5x11	400
4402 RPB 125 F18	125	40	181	51	166	140x110	105x80	13.5x11	500
4402 RPB 150 F18	150	45	215	56.5	165	140x110	105x80	13.5x11	600
4402 RPB 200 F18	200	50	258	60	162	140x110	105x80	13.5x11	900











YÖN KİLİTLİ

RPB		AĞIR TİP POLİAMİD TEKER BURÇLU							
KOD NO									
	mm	mm	mm	mm	mm	mm	mm	mm	kg
4402 RPB 100 F17	100	35	150	46.5	145	140x110	105x80	13.5x11	400
4402 RPB 125 F17	125	40	181	48	145	140x110	105x80	13.5x11	500
4402 RPB 150 F17	150	45	215	52	145	140x110	105x80	13.5x11	600
4402 RPB 200 F17	200	50	258	58	145	140x110	105x80	13.5x11	900







RPR		AĞIR TİP POLİAMİD TEKER RULMANLI							
KOD NO									
	mm	mm	mm	mm	mm	mm	mm	mm	kg
4402 RPR 100	100	35	150	46.5	140x110	105x80	13.5x11	400	
4402 RPR 125	125	40	181	48	140x110	105x80	13.5x11	500	
4402 RPR 150	150	45	215	52	140x110	105x80	13.5x11	600	
4402 RPR 200	200	50	258	58	140x110	105x80	13.5x11	900	



RPR		AĞIR TİP POLİAMİD TEKER RULMANLI							
KOD NO									
	mm	mm	mm	mm	mm	mm	mm	mm	kg
4402 RPR 100 F18	100	35	150	50.5	163	140x110	105x80	13.5x11	400
4402 RPR 125 F18	125	40	181	51	166	140x110	105x80	13.5x11	500
4402 RPR 150 F18	150	45	215	56.5	165	140x110	105x80	13.5x11	600
4402 RPR 200 F18	200	50	258	60	162	140x110	105x80	13.5x11	900



YÖN KİLİTLİ

RPR		AĞIR TİP POLİAMİD TEKER RULMANLI							
KOD NO									
	mm	mm	mm	mm	mm	mm	mm	mm	kg
4402 RPR 100 F17	100	35	150	46.5	145	140x110	105x80	13.5x11	400
4402 RPR 125 F17	125	40	181	48	145	140x110	105x80	13.5x11	500
4402 RPR 150 F17	150	45	215	52	145	140x110	105x80	13.5x11	600
4402 RPR 200 F17	200	50	258	58	145	140x110	105x80	13.5x11	900



KPR		KAMALON KASNAK ÜZERİ POLİAMİD KAPLAMA RULMANLI							
KOD NO									
	mm	mm	mm	mm	mm	mm	mm	mm	kg
4402 KPR 100	100	40	150	46.5	140x110	105x80	13.5x11	350	
4402 KPR 125	125	50	181	48	140x110	105x80	13.5x11	450	
4402 KPR 150	150	50	215	52	140x110	105x80	13.5x11	700	
4402 KPR 160	160	50	208	61	140x110	105x80	13.5x11	800	
4402 KPR 200	200	50	258	58	140x110	105x80	13.5x11	1000	



KPR		KAMALON KASNAK ÜZERİ POLİAMİD KAPLAMA RULMANLI							
KOD NO									
	mm	mm	mm	mm	mm	mm	mm	mm	kg
4402 KPR 100 F18	100	40	150	50.5	163	140x110	105x80	13.5x11	350
4402 KPR 125 F18	125	50	181	51	166	140x110	105x80	13.5x11	450
4402 KPR 150 F18	150	50	215	56.5	165	140x110	105x80	13.5x11	700
4402 KPR 160 F18	160	50	208	58	161	140x110	105x80	13.5x11	800
4402 KPR 200 F18	200	50	258	60	162	140x110	105x80	13.5x11	1000











YÖN KİLİTLİ

KPR		KAMALON KASNAK ÜZERİ POLİAMİD KAPLAMA RULMANLI							
KOD NO									
	mm	mm	mm	mm	mm	mm	mm	mm	kg
4402 KPR 100 F17	100	40	150	46.5	145	140x110	105x80	13.5x11	350
4402 KPR 125 F17	125	50	181	48	145	140x110	105x80	13.5x11	450
4402 KPR 150 F17	150	50	215	52	145	140x110	105x80	13.5x11	700
4402 KPR 160 F17	160	50	208	61	145	140x110	105x80	13.5x11	800
4402 KPR 200 F17	200	50	258	58	145	140x110	105x80	13.5x11	1000











K2PR		KAMALON KASNAK ÜZERİ OVAL POLİAMİD KAPLAMA RULMANLI							
KOD NO									
	mm	mm	mm	mm	mm	mm	mm	mm	kg
4402 K2PR 100	100	40	150	46.5	140x110	105x80	13.5x11	350	
4402 K2PR 125	125	50	181	48	140x110	105x80	13.5x11	450	
4402 K2PR 150	150	50	215	52	140x110	105x80	13.5x11	700	
4402 K2PR 160	160	50	208	61	140x110	105x80	13.5x11	800	
4402 K2PR 200	200	50	258	58	140x110	105x80	13.5x11	1000	

K2PR
KAMALON KASNAK ÜZERİ OVAL POLİAMİD KAPLAMA RULMANLI

KOD NO	 mm	 mm	 mm	 mm	 mm	 mm	 mm	 mm	 kg
4402 K2PR 100 F18	100	40	150	50.5	163	140x110	105x80	13.5x11	350
4402 K2PR 125 F18	125	50	181	51	166	140x110	105x80	13.5x11	450
4402 K2PR 150 F18	150	50	215	56.5	165	140x110	105x80	13.5x11	700
4402 K2PR 160 F18	160	50	208	58	161	140x110	105x80	13.5x11	800
4402 K2PR 200 F18	200	50	258	60	162	140x110	105x80	13.5x11	1000

YÖN KİLİTLİ
K2PR
KAMALON KASNAK ÜZERİ OVAL POLİAMİD KAPLAMA RULMANLI

KOD NO	 mm	 mm	 mm	 mm	 mm	 mm	 mm	 mm	 kg
4402 K2PR 100 F17	100	40	150	46.5	145	140x110	105x80	13.5x11	350
4402 K2PR 125 F17	125	50	181	48	145	140x110	105x80	13.5x11	450
4402 K2PR 150 F17	150	50	215	52	145	140x110	105x80	13.5x11	700
4402 K2PR 160 F17	160	50	208	61	145	140x110	105x80	13.5x11	800
4402 K2PR 200 F17	200	50	258	58	145	140x110	105x80	13.5x11	1000

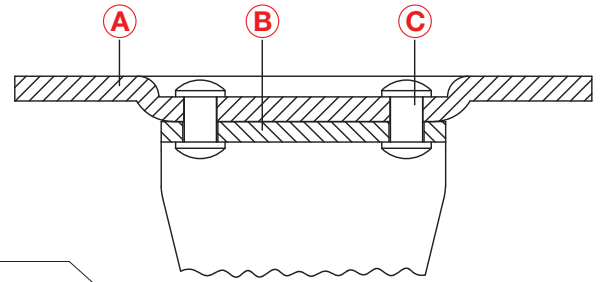

- A:** SABİT TABLA
B: SABİT MAŞA
C: DEMİR PERÇİN

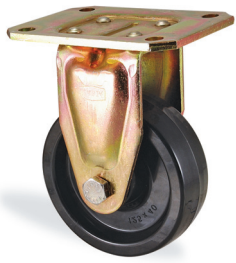
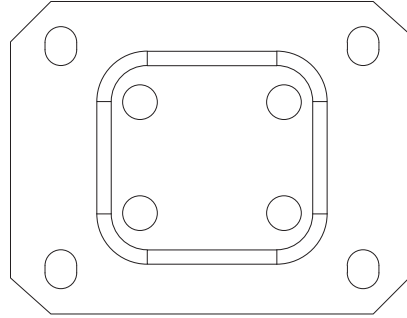



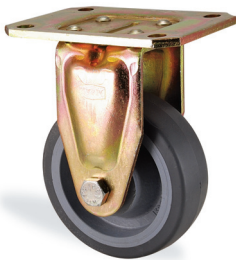

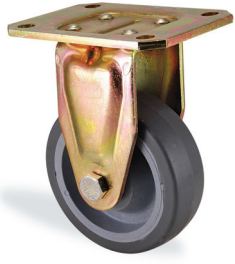

BBC
ISIYA DAYANIKLI BAKALİT TEKER PİRİNÇ BURÇLU (+250°C)

KOD NO	mm	mm	mm	mm	mm	mm	kg
4407 BBC 100	100	35	150	140x110	105x80	13.5x11	150
4407 BBC 125	125	40	181	140x110	105x80	13.5x11	300
4407 BBC 150	150	45	215	140x110	105x80	13.5x11	450
4407 BBC 200	200	50	258	140x110	105x80	13.5x11	600







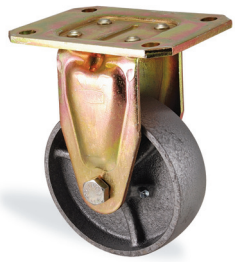

CTB
GÜÇLENDİRİLMİŞ POLİAMİD KASNAK ÜZERİ TERMOELASTİK GRİ LASTİK KAPLAMA BURÇLU

KOD NO	mm	mm	mm	mm	mm	mm	kg
4407 CTB 100	100	35	150	140x110	105x80	13.5x11	120
4407 CTB 125	125	40	181	140x110	105x80	13.5x11	150
4407 CTB 150	150	45	215	140x110	105x80	13.5x11	180
4407 CTB 200	200	50	258	140x110	105x80	13.5x11	250







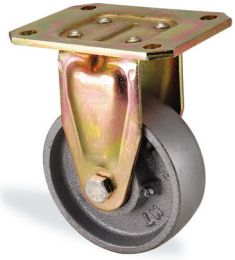

CTR GÜÇLENDİRİLMİŞ POLİAMİD KASNAK ÜZERİ TERMOELASTİK GRİ LASTİK KAPLAMA RULMANLI

KOD NO	 mm	 mm	 mm	 mm	 mm	 mm	 kg
4407 CTR 100	100	35	150	140x110	105x80	13.5x11	120
4407 CTR 125	125	40	181	140x110	105x80	13.5x11	150
4407 CTR 150	150	45	215	140x110	105x80	13.5x11	180
4407 CTR 200	200	50	258	140x110	105x80	13.5x11	250







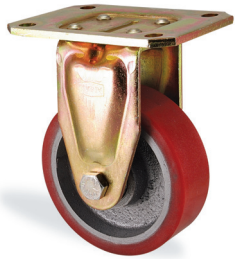

DDB DÖKÜM TEKER BURÇLU

KOD NO	 mm	 mm	 mm	 mm	 mm	 mm	 kg
4407 DDB 100	100	35	150	140x110	105x80	13.5x11	400
4407 DDB 125	125	40	181	140x110	105x80	13.5x11	500
4407 DDB 150	150	45	215	140x110	105x80	13.5x11	800
4407 DDB 200	200	50	258	140x110	105x80	13.5x11	1100







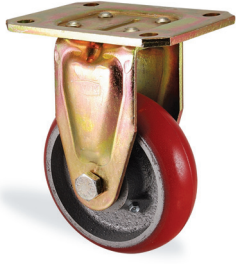

DDR DÖKÜM TEKER RULMANLI

KOD NO	 mm	 mm	 mm	 mm	 mm	 mm	 kg
4407 DDR 100	100	35	150	140x110	105x80	13.5x11	400
4407 DDR 125	125	40	181	140x110	105x80	13.5x11	500
4407 DDR 150	150	45	215	140x110	105x80	13.5x11	800
4407 DDR 200	200	50	258	140x110	105x80	13.5x11	1100







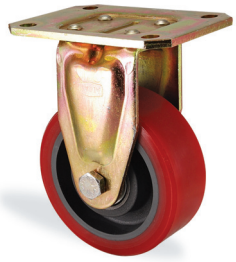

DOR DÖKÜM ÜZERİ DÖKME POLİÜRETAN KAPLAMA RULMANLI

KOD NO	 mm	 mm	 mm	 mm	 mm	 mm	 kg
4407 DOR 100	100	35	150	140x110	105x80	13.5x11	350
4407 DOR 125	125	40	181	140x110	105x80	13.5x11	450
4407 DOR 150	150	45	215	140x110	105x80	13.5x11	700
4407 DOR 200	200	50	258	140x110	105x80	13.5x11	1000









D2OR
DÖKÜM ÜZERİ OVAL DÖKME POLİÜRETAN KAPLAMA RULMANLI

KOD NO	 mm	 mm	 mm	 mm	 mm	 mm	 kg
4407 D2OR 100	100	35	150	140x110	105x80	13.5x11	350
4407 D2OR 125	125	40	181	140x110	105x80	13.5x11	450
4407 D2OR 150	150	45	215	140x110	105x80	13.5x11	700
4407 D2OR 200	200	50	258	140x110	105x80	13.5x11	1000







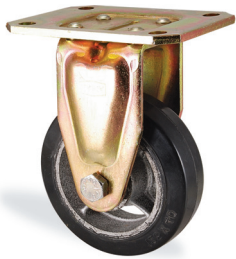

KOR
KAMALON ÜZERİ DÖKME POLİÜRETAN KAPLAMA RULMANLI

KOD NO	 mm	 mm	 mm	 mm	 mm	 mm	 kg
4407 KOR 100	100	40	150	140x110	105x80	13.5x11	350
4407 KOR 125	125	50	181	140x110	105x80	13.5x11	450
4407 KOR 150	150	50	215	140x110	105x80	13.5x11	700
4407 KOR 160	160	50	208	140x110	105x80	13.5x11	800
4407 KOR 200	200	50	258	140x110	105x80	13.5x11	1000

K2OR
KAMALON ÜZERİ OVAL DÖKME POLİÜRETAN KAPLAMA RULMANLI

KOD NO	 mm	 mm	 mm	 mm	 mm	 mm	 kg
4407 K2OR 100	100	40	150	140x110	105x80	13.5x11	350
4407 K2OR 125	125	50	181	140x110	105x80	13.5x11	450
4407 K2OR 150	150	50	215	140x110	105x80	13.5x11	700
4407 K2OR 160	160	50	208	140x110	105x80	13.5x11	800
4407 K2OR 200	200	50	258	140x110	105x80	13.5x11	1000

DYR
DÖKÜM ÜZERİ VULKANİZE LASTİK KAPLAMA RULMANLI

KOD NO	 mm	 mm	 mm	 mm	 mm	 mm	 kg
4407 DYR 100	100	35	150	140x110	105x80	13.5x11	140
4407 DYR 125	125	40	181	140x110	105x80	13.5x11	180
4407 DYR 150	150	45	215	140x110	105x80	13.5x11	200
4407 DYR 200	200	50	258	140x110	105x80	13.5x11	350









KYR		KAMALON KASNAK ÜZERİ VULKANİZE SİYAH LASTİK KAPLAMA RULMANLI					
KOD NO	 mm	 mm	 mm	 mm	 mm	 mm	kg
4407 KYR 100	100	40	150	140x110	105x80	13.5x11	140
4407 KYR 125	125	40	181	140x110	105x80	13.5x11	180
4407 KYR 150	150	45	215	140x110	105x80	13.5x11	200
4407 KYR 160	160	50	208	140x110	105x80	13.5x11	240
4407 KYR 200	200	50	258	140x110	105x80	13.5x11	350



KER		KAMALON KASNAK ÜZERİ VULKANİZE GRİ LASTİK KAPLAMA RULMANLI					
KOD NO	 mm	 mm	 mm	 mm	 mm	 mm	kg
4407 KER 100	100	40	150	140x110	105x80	13.5x11	140
4407 KER 125	125	40	181	140x110	105x80	13.5x11	180
4407 KER 150	150	45	215	140x110	105x80	13.5x11	200
4407 KER 160	160	50	208	140x110	105x80	13.5x11	240
4407 KER 200	200	50	258	140x110	105x80	13.5x11	350





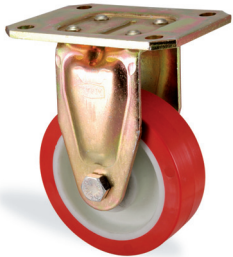



PUB		POLİAMİD KASNAK ÜZERİ POLİÜRETAN KAPLAMA BURÇLU					
KOD NO	 mm	 mm	 mm	 mm	 mm	 mm	kg
4407 PUB 100	100	35	150	140x110	105x80	13.5x11	200
4407 PUB 125	125	40	181	140x110	105x80	13.5x11	250
4407 PUB 150	150	45	215	140x110	105x80	13.5x11	400
4407 PUB 200	200	50	258	140x110	105x80	13.5x11	600







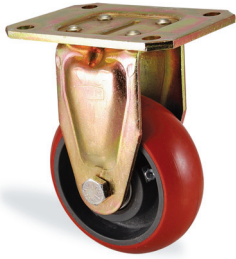

PUR		POLİAMİD KASNAK ÜZERİ POLİÜRETAN KAPLAMA RULMANLI					
KOD NO	 mm	 mm	 mm	 mm	 mm	 mm	kg
4407 PUR 100	100	35	150	140x110	105x80	13.5x11	200
4407 PUR 125	125	40	181	140x110	105x80	13.5x11	250
4407 PUR 150	150	45	215	140x110	105x80	13.5x11	400
4407 PUR 200	200	50	258	140x110	105x80	13.5x11	600









KUR
KAMALON ÜZERİ ENJEKSİYON POLİÜRETAN KAPLAMA RULMANLI

KOD NO	 mm	 mm	 mm	 mm	 mm	 mm	 kg
4407 KUR 100	100	40	150	140x110	105x80	13.5x11	250
4407 KUR 125	125	50	181	140x110	105x80	13.5x11	300
4407 KUR 150	150	50	215	140x110	105x80	13.5x11	550
4407 KUR 160	160	50	208	140x110	105x80	13.5x11	650
4407 KUR 200	200	50	258	140x110	105x80	13.5x11	800









K2UR
KAMALON KASNAK ÜZERİ OVAL ENJEKSİYON POLİÜRETAN KAPLAMA RULMANLI

KOD NO	 mm	 mm	 mm	 mm	 mm	 mm	 kg
4407 K2UR 100	100	40	150	140x110	105x80	13.5x11	250
4407 K2UR 125	125	50	181	140x110	105x80	13.5x11	300
4407 K2UR 150	150	50	215	140x110	105x80	13.5x11	550
4407 K2UR 160	160	50	208	140x110	105x80	13.5x11	650
4407 K2UR 200	200	50	258	140x110	105x80	13.5x11	800









RMB
AĞIR TİP MOBLEN (PP) TEKER BURÇLU

KOD NO	 mm	 mm	 mm	 mm	 mm	 mm	 kg
4407 RMB 100	100	35	150	140x110	105x80	13.5x11	300
4407 RMB 125	125	40	181	140x110	105x80	13.5x11	400
4407 RMB 150	150	45	215	140x110	105x80	13.5x11	500
4407 RMB 200	200	50	258	140x110	105x80	13.5x11	800

RPB
AĞIR TİP POLİAMİD TEKER BURÇLU

KOD NO	 mm	 mm	 mm	 mm	 mm	 mm	 kg
4407 RPB 100	100	35	150	140x110	105x80	13.5x11	400
4407 RPB 125	125	40	181	140x110	105x80	13.5x11	500
4407 RPB 150	150	45	215	140x110	105x80	13.5x11	600
4407 RPB 200	200	50	258	140x110	105x80	13.5x11	900



RPR		AĞIR TİP POLİAMİD TEKER RULMANLI						
KOD NO	 mm	 mm	 mm	 mm	 mm	 mm	 kg	
4407 RPR 100	100	35	150	140x110	105x80	13.5x11	400	
4407 RPR 125	125	40	181	140x110	105x80	13.5x11	500	
4407 RPR 150	150	45	215	140x110	105x80	13.5x11	600	
4407 RPR 200	200	50	258	140x110	105x80	13.5x11	900	



KPR		KAMALON KASNAK ÜZERİ POLİAMİD KAPLAMA RULMANLI						
KOD NO	 mm	 mm	 mm	 mm	 mm	 mm	 kg	
4407 KPR 100	100	40	150	140x110	105x80	13.5x11	350	
4407 KPR 125	125	50	181	140x110	105x80	13.5x11	450	
4407 KPR 150	150	50	215	140x110	105x80	13.5x11	700	
4407 KPR 160	160	50	208	140x110	105x80	13.5x11	800	
4407 KPR 200	200	50	258	140x110	105x80	13.5x11	1000	



K2PR		KAMALON KASNAK ÜZERİ OVAL POLİAMİD KAPLAMA RULMANLI						
KOD NO	 mm	 mm	 mm	 mm	 mm	 mm	 kg	
4407 K2PR 100	100	40	150	140x110	105x80	13.5x11	350	
4407 K2PR 125	125	50	181	140x110	105x80	13.5x11	450	
4407 K2PR 150	150	50	215	140x110	105x80	13.5x11	700	
4407 K2PR 160	160	50	208	140x110	105x80	13.5x11	800	
4407 K2PR 200	200	50	258	140x110	105x80	13.5x11	1000	

- A:** DÖVME OYNAK TABLA
- B:** BÜTE RULMAN
- C:** TABLA BAĞLANTI CİVATASI
- D:** KONİK RULMAN
- E:** DÖVME MAŞA ÇANAĞI
- F:** GRESÖRLÜK
- G:** MAŞA AYAK KAYNAĞI
- H:** SAC METAL TOZLUK
- I:** AYARLANABİLİR TAÇLI SOMUN
- J:** YARIKLI PİM
- K:** OYNAK MAŞA AYAĞI

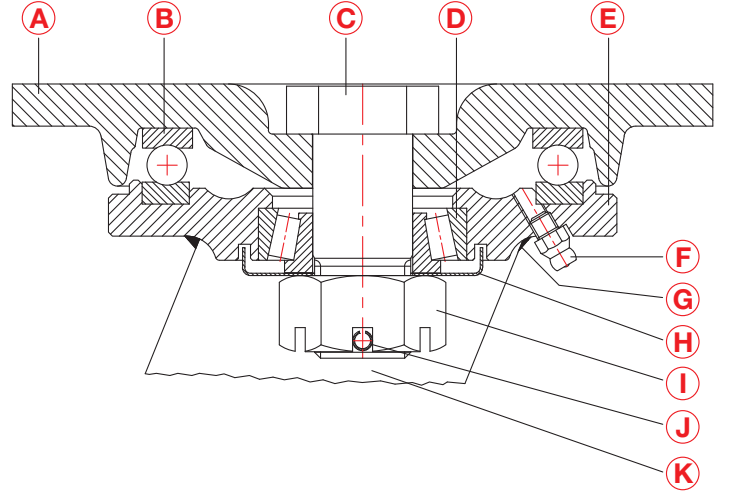









DDR
DÖKÜM TEKER RULMANLI

KOD NO	mm	mm	mm	mm	mm	mm	mm	kg
5102 DDR 150	150	45	220	44	175x140	140x105	26x15	800
5102 DDR 200	200	50	265	52	175x140	140x105	26x15	1100
5102 DDR 250	250	50	320	64	175x140	140x105	26x15	1300











DDR
DÖKÜM TEKER RULMANLI

KOD NO	mm	mm	mm	mm	mm	mm	mm	mm	kg
5102 DDR 150 F09	150	45	220	44	121.3	175x140	140x105	26x15	800
5102 DDR 200 F09	200	50	265	52	121.3	175x140	140x105	26x15	1100
5102 DDR 250 F09	250	50	320	64	121.3	175x140	140x105	26x15	1300







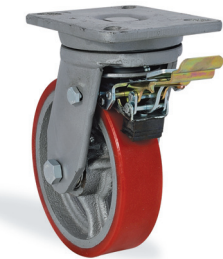

YÖN KİLİTLİ

DDR		DÖKÜM TEKER RULMANLI							
KOD NO									
	mm	mm	mm	mm	mm	mm	mm	mm	kg
5102 DDR 150 F20	150	45	220	44	172	175x140	140x105	26x15	800
5102 DDR 200 F20	200	50	265	52	172	175x140	140x105	26x15	1100
5102 DDR 250 F20	250	50	320	64	172	175x140	140x105	26x15	1300



DOR		DÖKÜM KASNAK ÜZERİ DÖKME POLİÜRETAN KAPLAMA RULMANLI							
KOD NO									
	mm	mm	mm	mm	mm	mm	mm	mm	kg
5102 DOR 150	150	45	220	44	175x140	140x105	26x15	26x15	700
5102 DOR 180	180	50	255	52	175x140	140x105	26x15	26x15	900
5102 DOR 200	200	50	265	52	175x140	140x105	26x15	26x15	1000
5102 DOR 250	250	60	320	64	175x140	140x105	26x15	26x15	1350
5102 DOR 260	260	65	325	64	175x140	140x105	26x15	26x15	1400
5102 DOR 300	300	70	364	71	175x140	140x105	26x15	26x15	1600
5102 DOR 350	350	80	412	80	175x140	140x105	26x15	26x15	2200



DOR		DÖKÜM KASNAK ÜZERİ DÖKME POLİÜRETAN KAPLAMA RULMANLI							
KOD NO									
	mm	mm	mm	mm	mm	mm	mm	mm	kg
5102 DOR 150 F09	150	45	220	44	121.3	175x140	140x105	26x15	700
5102 DOR 180 F09	180	50	255	52	121.3	175x140	140x105	26x15	900
5102 DOR 200 F09	200	50	265	52	121.3	175x140	140x105	26x15	1000
5102 DOR 250 F09	250	60	320	64	121.3	175x140	140x105	26x15	1350
5102 DOR 260 F09	260	65	325	64	121.3	175x140	140x105	26x15	1400
5102 DOR 300 F09	300	70	364	71	121.3	175x140	140x105	26x15	1600
5102 DOR 350 F09	350	80	412	80	121.3	175x140	140x105	26x15	2200

YÖN KİLİTLİ

DOR		DÖKÜM KASNAK ÜZERİ DÖKME POLİÜRETAN KAPLAMA RULMANLI							
KOD NO									
	mm	mm	mm	mm	mm	mm	mm	mm	kg
5102 DOR 150 F20	150	45	220	44	172	175x140	140x105	26x15	700
5102 DOR 180 F20	180	50	255	52	172	175x140	140x105	26x15	900
5102 DOR 200 F20	200	50	265	52	172	175x140	140x105	26x15	1000
5102 DOR 250 F20	250	60	320	64	172	175x140	140x105	26x15	1350
5102 DOR 260 F20	260	65	325	64	172	175x140	140x105	26x15	1400
5102 DOR 300 F20	300	70	364	71	172	175x140	140x105	26x15	1600
5102 DOR 350 F20	350	80	412	80	172	175x140	140x105	26x15	2200



D2OR		DÖKÜM KASNAK ÜZERİ OVAL DÖKME POLİÜRETAN KAPLAMA RULMANLI							
KOD NO									
	mm	mm	mm	mm	mm	mm	mm	mm	kg
5102 D2OR 150	150	45	220	44	175x140	140x105	26x15	700	
5102 D2OR 180	180	50	255	52	175x140	140x105	26x15	900	
5102 D2OR 200	200	50	265	52	175x140	140x105	26x15	1000	
5102 D2OR 250	250	60	320	64	175x140	140x105	26x15	1350	
5102 D2OR 260	260	65	325	64	175x140	140x105	26x15	1400	
5102 D2OR 300	300	70	364	71	175x140	140x105	26x15	1600	

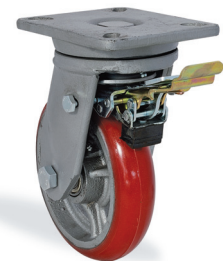









D2OR		DÖKÜM KASNAK ÜZERİ OVAL DÖKME POLİÜRETAN KAPLAMA RULMANLI							
KOD NO									
	mm	mm	mm	mm	mm	mm	mm	mm	kg
5102 D2OR 150 F09	150	45	220	44	121.3	175x140	140x105	26x15	700
5102 D2OR 180 F09	180	50	255	52	121.3	175x140	140x105	26x15	900
5102 D2OR 200 F09	200	50	265	52	121.3	175x140	140x105	26x15	1000
5102 D2OR 250 F09	250	60	320	64	121.3	175x140	140x105	26x15	1350
5102 D2OR 260 F09	260	65	325	64	121.3	175x140	140x105	26x15	1400
5102 D2OR 300 F09	300	70	364	71	121.3	175x140	140x105	26x15	1600



YÖN KİLİTLİ

D2OR









DÖKÜM KASNAK ÜZERİ OVAL DÖKME POLİÜRETAN KAPLAMA RULMANLI

KOD NO	 mm	 mm	 mm	 mm	 mm	 mm	 mm	 mm	 kg
5102 D2OR 150 F20	150	45	220	44	172	175x140	140x105	26x15	700
5102 D2OR 180 F20	180	50	255	52	172	175x140	140x105	26x15	900
5102 D2OR 200 F20	200	50	265	52	172	175x140	140x105	26x15	1000
5102 D2OR 250 F20	250	60	320	64	172	175x140	140x105	26x15	1350
5102 D2OR 260 F20	260	65	325	64	172	175x140	140x105	26x15	1400
5102 D2OR 300 F20	300	70	364	71	172	175x140	140x105	26x15	1600



KOR





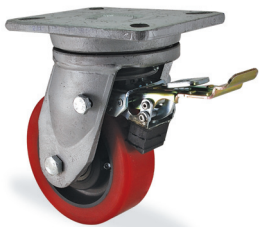



KAMALON KASNAK ÜZERİ DÖKME POLİÜRETAN KAPLAMA RULMANLI

KOD NO	 mm	 mm	 mm	 mm	 mm	 mm	 mm	 mm	 kg
5102 KOR 150	150	50	220	44	175x140	140x105	26x15	700	
5102 KOR 160	160	50	225	44	175x140	140x105	26x15	800	
5102 KOR 180	180	50	255	52	175x140	140x105	26x15	900	
5102 KOR 200	200	50	265	52	175x140	140x105	26x15	1000	
5102 KOR 250	250	50	320	64	175x140	140x105	26x15	1200	











KOR









KAMALON KASNAK ÜZERİ DÖKME POLİÜRETAN KAPLAMA RULMANLI

KOD NO	 mm	 mm	 mm	 mm	 mm	 mm	 mm	 mm	 kg
5102 KOR 150 F09	150	50	220	44	121.3	175x140	140x105	26x15	700
5102 KOR 160 F09	160	50	225	44	121.3	175x140	140x105	26x15	800
5102 KOR 180 F09	180	50	255	52	121.3	175x140	140x105	26x15	900
5102 KOR 200 F09	200	50	265	52	121.3	175x140	140x105	26x15	1000
5102 KOR 250 F09	250	50	320	64	121.3	175x140	140x105	26x15	1200









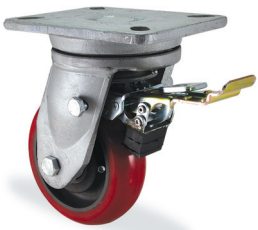

YÖN KİLİTLİ
KOR
KAMALON KASNAK ÜZERİ DÖKME POLİÜRETAN KAPLAMA RULMANLI

KOD NO	 mm	 mm	 mm	 mm	 mm	 mm	 mm	 mm	 kg
5102 KOR 150 F20	150	50	220	44	172	175x140	140x105	26x15	700
5102 KOR 160 F20	160	50	225	44	172	175x140	140x105	26x15	800
5102 KOR 180 F20	180	50	255	52	172	175x140	140x105	26x15	900
5102 KOR 200 F20	200	50	265	52	172	175x140	140x105	26x15	1000
5102 KOR 250 F20	250	50	320	64	172	175x140	140x105	26x15	1200

K2OR
KAMALON KASNAK ÜZERİ OVAL DÖKME POLİÜRETAN KAPLAMA RULMANLI

KOD NO	 mm	 mm	 mm	 mm	 mm	 mm	 mm	 mm	 kg
5102 K2OR 150	150	50	220	44	175x140	140x105	26x15	700	
5102 K2OR 160	160	50	225	44	175x140	140x105	26x15	800	
5102 K2OR 180	180	50	255	52	175x140	140x105	26x15	900	
5102 K2OR 200	200	50	265	52	175x140	140x105	26x15	1000	
5102 K2OR 250	250	50	320	64	175x140	140x105	26x15	1200	

K2OR
KAMALON KASNAK ÜZERİ OVAL DÖKME POLİÜRETAN KAPLAMA RULMANLI









KOD NO	 mm	 mm	 mm	 mm	 mm	 mm	 mm	 mm	 kg
5102 K2OR 150 F09	150	50	220	44	121.3	175x140	140x105	26x15	700
5102 K2OR 160 F09	160	50	225	44	121.3	175x140	140x105	26x15	800
5102 K2OR 180 F09	180	50	255	52	121.3	175x140	140x105	26x15	900
5102 K2OR 200 F09	200	50	265	52	121.3	175x140	140x105	26x15	1000
5102 K2OR 250 F09	250	50	320	64	121.3	175x140	140x105	26x15	1200



YÖN KİLİTLİ

K2OR









KAMALON KASNAK ÜZERİ OVAL DÖKME POLİÜRETAN KAPLAMA RULMANLI

KOD NO	 mm	 mm	 mm	 mm	 mm	 mm	 mm	 mm	 kg
5102 K2OR 150 F20	150	50	220	44	172	175x140	140x105	26x15	700
5102 K2OR 160 F20	160	50	225	44	172	175x140	140x105	26x15	800
5102 K2OR 180 F20	180	50	255	52	172	175x140	140x105	26x15	900
5102 K2OR 200 F20	200	50	265	52	172	175x140	140x105	26x15	1000
5102 K2OR 250 F20	250	50	320	64	172	175x140	140x105	26x15	1200



DYR









DÖKÜM KASNAK ÜZERİ VULKANİZE LASTİK KAPLAMA RULMANLI

KOD NO	 mm	 mm	 mm	 mm	 mm	 mm	 mm	 mm	 kg
5102 DYR 150	150	45	220	44	175x140	140x105	26x15	200	
5102 DYR 170	170	45	238	44	175x140	140x105	26x15	240	
5102 DYR 200	200	50	265	52	175x140	140x105	26x15	350	
5102 DYR 220	220	50	284	55	175x140	140x105	26x15	450	
5102 DYR 250	250	60	320	64	175x140	140x105	26x15	500	
5102 DYR 300	300	70	364	71	175x140	140x105	26x15	600	
5102 DYR 350	350	80	412	80	175x140	140x105	26x15	650	
5102 DYR 380	380	80	440	85	175x140	140x105	26x15	800	











DYR









DÖKÜM KASNAK ÜZERİ VULKANİZE LASTİK KAPLAMA RULMANLI

KOD NO	 mm	 mm	 mm	 mm	 mm	 mm	 mm	 mm	 kg
5102 DYR 150 F09	150	45	220	44	121.3	175x140	140x105	26x15	200
5102 DYR 170 F09	170	45	238	44	121.3	175x140	140x105	26x15	240
5102 DYR 200 F09	200	50	265	52	121.3	175x140	140x105	26x15	350
5102 DYR 220 F09	220	50	284	55	121.3	175x140	140x105	26x15	450
5102 DYR 250 F09	250	60	320	64	121.3	175x140	140x105	26x15	500
5102 DYR 300 F09	300	70	364	71	121.3	175x140	140x105	26x15	600
5102 DYR 350 F09	350	80	412	80	121.3	175x140	140x105	26x15	650
5102 DYR 380 F09	380	80	440	85	121.3	175x140	140x105	26x15	800











YÖN KİLİTLİ
DYR
DÖKÜM KASNAK ÜZERİ VULKANİZE LASTİK KAPLAMA RULMANLI

KOD NO	 mm	 mm	 mm	 mm	 mm	 mm	 mm	 mm	 kg
5102 DYR 150 F20	150	45	220	44	172	175x140	140x105	26x15	200
5102 DYR 170 F20	170	45	238	44	172	175x140	140x105	26x15	240
5102 DYR 200 F20	200	50	265	52	172	175x140	140x105	26x15	350
5102 DYR 220 F20	220	50	284	55	172	175x140	140x105	26x15	450
5102 DYR 250 F20	250	60	320	64	172	175x140	140x105	26x15	500
5102 DYR 300 F20	300	70	364	71	172	175x140	140x105	26x15	600
5102 DYR 350 F20	350	80	412	80	172	175x140	140x105	26x15	650
5102 DYR 380 F20	380	80	440	85	172	175x140	140x105	26x15	800

KYR
KAMALON KASNAK ÜZERİ VULKANİZE SİYAH LASTİK KAPLAMA RULMANLI

KOD NO	 mm	 mm	 mm	 mm	 mm	 mm	 mm	 mm	 kg
5102 KYR 150	150	45	220	44	175x140	140x105	26x15	200	
5102 KYR 160	160	50	225	44	175x140	140x105	26x15	240	
5102 KYR 200	200	50	265	52	175x140	140x105	26x15	350	
5102 KYR 250	250	50	320	64	175x140	140x105	26x15	500	

KYR
KAMALON KASNAK ÜZERİ VULKANİZE SİYAH LASTİK KAPLAMA RULMANLI

KOD NO	 mm	 mm	 mm	 mm	 mm	 mm	 mm	 mm	 kg
5102 KYR 150 F09	150	45	220	44	121.3	175x140	140x105	26x15	200
5102 KYR 160 F09	160	50	225	44	121.3	175x140	140x105	26x15	240
5102 KYR 200 F09	200	50	265	52	121.3	175x140	140x105	26x15	350
5102 KYR 250 F09	250	50	320	64	121.3	175x140	140x105	26x15	500

YÖN KİLİTLİ

KYR		KAMALON KASNAK ÜZERİ VULKANİZE SİYAH LASTİK KAPLAMA RULMANLI							
KOD NO									
	mm	mm	mm	mm	mm	mm	mm	mm	kg
5102 KYR 150 F20	150	45	220	44	172	175x140	140x105	26x15	200
5102 KYR 160 F20	160	50	225	44	172	175x140	140x105	26x15	240
5102 KYR 200 F20	200	50	265	52	172	175x140	140x105	26x15	350
5102 KYR 250 F20	250	50	320	64	172	175x140	140x105	26x15	500











KER		KAMALON KASNAK ÜZERİ VULKANİZE GRİ LASTİK KAPLAMA RULMANLI							
KOD NO									
	mm	mm	mm	mm	mm	mm	mm	mm	kg
5102 KER 150	150	45	220	44	175x140	140x105	26x15	200	
5102 KER 160	160	50	225	44	175x140	140x105	26x15	240	
5102 KER 200	200	50	265	52	175x140	140x105	26x15	350	
5102 KER 250	250	50	320	64	175x140	140x105	26x15	500	











KER		KAMALON KASNAK ÜZERİ VULKANİZE GRİ LASTİK KAPLAMA RULMANLI							
KOD NO									
	mm	mm	mm	mm	mm	mm	mm	mm	kg
5102 KER 150 F09	150	45	220	44	121.3	175x140	140x105	26x15	200
5102 KER 160 F09	160	50	225	44	121.3	175x140	140x105	26x15	240
5102 KER 200 F09	200	50	265	52	121.3	175x140	140x105	26x15	350
5102 KER 250 F09	250	50	320	64	121.3	175x140	140x105	26x15	500









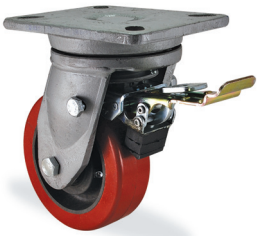

YÖN KİLİTLİ
KER
KAMALON KASNAK ÜZERİ VULKANİZE GRİ LASTİK KAPLAMA RULMANLI

KOD NO	 mm	 mm	 mm	 mm	 mm	 mm	 mm	 mm	 kg
5102 KER 150 F20	150	45	220	44	172	175x140	140x105	26x15	200
5102 KER 160 F20	160	50	225	44	172	175x140	140x105	26x15	240
5102 KER 200 F20	200	50	265	52	172	175x140	140x105	26x15	350
5102 KER 250 F20	250	50	320	64	172	175x140	140x105	26x15	500











KUR
KAMALON KASNAK ÜZERİ ENJEKSİYON POLİÜRETAN KAPLAMA RULMANLI

KOD NO	 mm	 mm	 mm	 mm	 mm	 mm	 mm	 mm	 kg
5102 KUR 150	150	50	220	44	175x140	140x105	26x15	26x15	550
5102 KUR 160	160	50	225	44	175x140	140x105	26x15	26x15	650
5102 KUR 200	200	50	265	52	175x140	140x105	26x15	26x15	800











KUR
KAMALON KASNAK ÜZERİ ENJEKSİYON POLİÜRETAN KAPLAMA RULMANLI

KOD NO	 mm	 mm	 mm	 mm	 mm	 mm	 mm	 mm	 kg
5102 KUR 150 F09	150	50	220	44	121.3	175x140	140x105	26x15	550
5102 KUR 160 F09	160	50	225	44	121.3	175x140	140x105	26x15	650
5102 KUR 200 F09	200	50	265	52	121.3	175x140	140x105	26x15	800











YÖN KİLİTLİ

KUR		KAMALON KASNAK ÜZERİ ENJEKSİYON POLİÜRETAN KAPLAMA RULMANLI							
KOD NO									
	mm	mm	mm	mm	mm	mm	mm	mm	kg
5102 KUR 150 F20	150	50	220	44	172	175x140	140x105	26x15	550
5102 KUR 160 F20	160	50	225	44	172	175x140	140x105	26x15	650
5102 KUR 200 F20	200	50	265	52	172	175x140	140x105	26x15	800











K2UR		KAMALON KASNAK ÜZERİ OVAL ENJEKSİYON POLİÜRETAN KAPLAMA RULMANLI							
KOD NO									
	mm	mm	mm	mm	mm	mm	mm	mm	kg
5102 K2UR 150	150	50	220	44	175x140	140x105	26x15	26x15	550
5102 K2UR 160	160	50	225	44	175x140	140x105	26x15	26x15	650
5102 K2UR 180	180	50	255	52	175x140	140x105	26x15	26x15	750
5102 K2UR 200	200	50	265	52	175x140	140x105	26x15	26x15	800











K2UR		KAMALON KASNAK ÜZERİ OVAL ENJEKSİYON POLİÜRETAN KAPLAMA RULMANLI							
KOD NO									
	mm	mm	mm	mm	mm	mm	mm	mm	kg
5102 K2UR 150 F09	150	50	220	44	121.3	175x140	140x105	26x15	550
5102 K2UR 160 F09	160	50	225	44	121.3	175x140	140x105	26x15	650
5102 K2UR 180 F09	180	50	255	52	121.3	175x140	140x105	26x15	750
5102 K2UR 200 F09	200	50	265	52	121.3	175x140	140x105	26x15	800











YÖN KİLİTLİ

K2UR		KAMALON KASNAK ÜZERİ OVAL ENJEKSİYON POLİÜRETAN KAPLAMA RULMANLI							
KOD NO	 mm	 mm	 mm	 mm	 mm	 mm	 mm	 mm	 kg
5102 K2UR 150 F20	150	50	220	44	172	175x140	140x105	26x15	550
5102 K2UR 160 F20	160	50	225	44	172	175x140	140x105	26x15	650
5102 K2UR 180 F20	180	50	255	52	172	175x140	140x105	26x15	750
5102 K2UR 200 F20	200	50	265	52	172	175x140	140x105	26x15	800











RPR		AĞIR TİP POLİAMİD TEKER RULMANLI							
KOD NO	 mm	 mm	 mm	 mm	 mm	 mm	 mm	 mm	 kg
5102 RPR 150	150	45	220	44	175x140	140x105	26x15	600	
5102 RPR 200	200	50	265	52	175x140	140x105	26x15	900	
5102 RPR 250	250	60	320	64	175x140	140x105	26x15	1100	
5102 RPR 270	270	70	349	71	175x140	140x105	26x15	1400	











RPR		AĞIR TİP POLİAMİD TEKER RULMANLI							
KOD NO	 mm	 mm	 mm	 mm	 mm	 mm	 mm	 mm	 kg
5102 RPR 150 F09	150	45	220	44	121.3	175x140	140x105	26x15	600
5102 RPR 200 F09	200	50	265	52	121.3	175x140	140x105	26x15	900
5102 RPR 250 F09	250	60	320	64	121.3	175x140	140x105	26x15	1100
5102 RPR 270 F09	270	70	349	71	121.3	175x140	140x105	26x15	1400











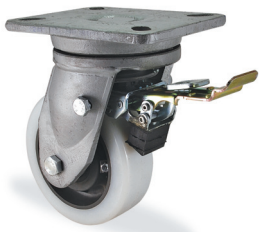

YÖN KİLİTLİ

RPR		AĞIR TİP POLİAMİD TEKER RULMANLI							
KOD NO									
	mm	mm	mm	mm	mm	mm	mm	mm	kg
5102 RPR 150 F20	150	45	220	44	172	175x140	140x105	26x15	600
5102 RPR 200 F20	200	50	265	52	172	175x140	140x105	26x15	900
5102 RPR 250 F20	250	60	320	64	172	175x140	140x105	26x15	1100
5102 RPR 270 F20	270	70	349	71	172	175x140	140x105	26x15	1400











KPR		KAMALON KASNAK ÜZERİ POLİAMİD KAPLAMA RULMANLI							
KOD NO									
	mm	mm	mm	mm	mm	mm	mm	mm	kg
5102 KPR 150	150	50	220	44	175x140	140x105	26x15	26x15	700
5102 KPR 160	160	50	225	44	175x140	140x105	26x15	26x15	800
5102 KPR 200	200	50	265	52	175x140	140x105	26x15	26x15	1000











KPR		KAMALON KASNAK ÜZERİ POLİAMİD KAPLAMA RULMANLI							
KOD NO									
	mm	mm	mm	mm	mm	mm	mm	mm	kg
5102 KPR 150 F09	150	50	220	44	121.3	175x140	140x105	26x15	700
5102 KPR 160 F09	160	50	225	44	121.3	175x140	140x105	26x15	800
5102 KPR 200 F09	200	50	265	52	121.3	175x140	140x105	26x15	1000









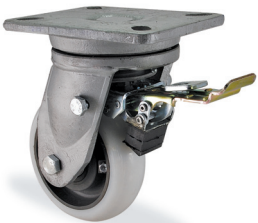

YÖN KİLİTLİ

KPR		KAMALON KASNAK ÜZERİ POLİAMİD KAPLAMA RULMANLI							
KOD NO									
	mm	mm	mm	mm	mm	mm	mm	mm	kg
5102 KPR 150 F20	150	50	220	44	172	175x140	140x105	26x15	700
5102 KPR 160 F20	160	50	225	44	172	175x140	140x105	26x15	800
5102 KPR 200 F20	200	50	265	52	172	175x140	140x105	26x15	1000



K2PR		KAMALON KASNAK ÜZERİ OVAL POLİAMİD KAPLAMA RULMANLI							
KOD NO									
	mm	mm	mm	mm	mm	mm	mm	mm	kg
5102 K2PR 150	150	50	220	44	175x140	140x105	26x15	26x15	700
5102 K2PR 160	160	50	225	44	175x140	140x105	26x15	26x15	800
5102 K2PR 180	180	50	255	52	175x140	140x105	26x15	26x15	900
5102 K2PR 200	200	50	265	52	175x140	140x105	26x15	26x15	1000













K2PR		KAMALON KASNAK ÜZERİ OVAL POLİAMİD KAPLAMA RULMANLI							
KOD NO									
	mm	mm	mm	mm	mm	mm	mm	mm	kg
5102 K2PR 150 F09	150	50	220	44	121.3	175x140	140x105	26x15	700
5102 K2PR 160 F09	160	50	225	44	121.3	175x140	140x105	26x15	800
5102 K2PR 180 F09	180	50	255	52	121.3	175x140	140x105	26x15	900
5102 K2PR 200 F09	200	50	265	52	121.3	175x140	140x105	26x15	1000



YÖN KİLİTLİ

K2PR

KAMALON KASNAK ÜZERİ OVAL POLİAMİD KAPLAMA RULMANLI

KOD NO	 mm	 mm	 mm	 mm	 mm	 mm	 mm	 mm	 mm	 kg
5102 K2PR 150 F20	150	50	220	44	172	175x140	140x105	26x15	700	
5102 K2PR 160 F20	160	50	225	44	172	175x140	140x105	26x15	800	
5102 K2PR 180 F20	180	50	255	52	172	175x140	140x105	26x15	900	
5102 K2PR 200 F20	200	50	265	52	172	175x140	140x105	26x15	1000	

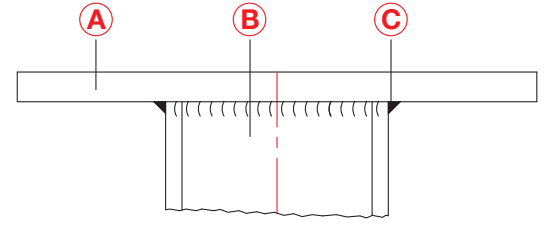

- A:** DÖVME SABİT TABLA
B: SABİT MAŞA AYAĞI
C: MAŞA AYAK KAYNAĞI

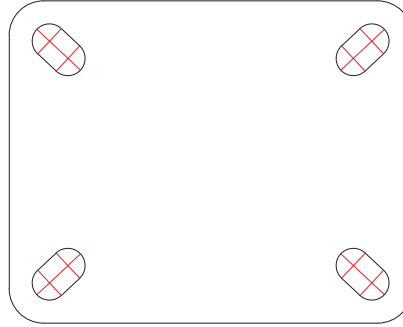







DDR		DÖKÜM TEKER RULMANLI					
KOD NO	mm	mm	mm	mm	mm	mm	kg
5107 DDR 150	150	45	220	175x140	140x105	26x15	800
5107 DDR 200	200	50	265	175x140	140x105	26x15	1100
5107 DDR 250	250	50	320	175x140	140x105	26x15	1300









DOR		DÖKÜM KASNAK ÜZERİ DÖKME POLİÜRETAN KAPLAMA RULMANLI					
KOD NO	mm	mm	mm	mm	mm	mm	kg
5107 DOR 150	150	45	220	175x140	140x105	26x15	700
5107 DOR 180	180	50	255	175x140	140x105	26x15	900
5107 DOR 200	200	50	265	175x140	140x105	26x15	1000
5107 DOR 250	250	60	320	175x140	140x105	26x15	1350
5107 DOR 260	260	65	325	175x140	140x105	26x15	1400
5107 DOR 300	300	70	364	175x140	140x105	26x15	1600
5107 DOR 350	350	80	412	175x140	140x105	26x15	2200









D2OR
DÖKÜM KASNAK ÜZERİ OVAL DÖKME POLİÜRETAN KAPLAMA RULMANLI

KOD NO	 mm	 mm	 mm	 mm	 mm	 mm	 kg
5107 D2OR 150	150	45	220	175x140	140x105	26x15	700
5107 D2OR 180	180	50	255	175x140	140x105	26x15	900
5107 D2OR 200	200	50	265	175x140	140x105	26x15	1000
5107 D2OR 250	250	60	320	175x140	140x105	26x15	1350
5107 D2OR 260	260	65	325	175x140	140x105	26x15	1400
5107 D2OR 300	300	70	364	175x140	140x105	26x15	1600









KOR
KAMALON KASNAK ÜZERİ DÖKME POLİÜRETAN KAPLAMA RULMANLI

KOD NO	 mm	 mm	 mm	 mm	 mm	 mm	 kg
5107 KOR 150	150	50	220	175x140	140x105	26x15	700
5107 KOR 160	160	50	225	175x140	140x105	26x15	800
5107 KOR 180	180	50	255	175x140	140x105	26x15	900
5107 KOR 200	200	50	252	175x140	140x105	26x15	1000
5107 KOR 250	250	50	320	175x140	140x105	26x15	1200

K2OR
KAMALON KASNAK ÜZERİ OVAL DÖKME POLİÜRETAN KAPLAMA RULMANLI

KOD NO	 mm	 mm	 mm	 mm	 mm	 mm	 kg
5107 K2OR 150	150	50	220	175x140	140x105	26x15	700
5107 K2OR 160	160	50	225	175x140	140x105	26x15	800
5107 K2OR 180	180	50	255	175x140	140x105	26x15	900
5107 K2OR 200	200	50	252	175x140	140x105	26x15	1000
5107 K2OR 250	250	50	320	175x140	140x105	26x15	1200

DYR
DÖKÜM KASNAK ÜZERİ VULKANİZE LASTİK KAPLAMA RULMANLI

KOD NO	 mm	 mm	 mm	 mm	 mm	 mm	 kg
5107 DYR 150	150	45	220	175x140	140x105	26x15	200
5107 DYR 170	170	45	238	175x140	140x105	26x15	240
5107 DYR 200	200	50	265	175x140	140x105	26x15	350
5107 DYR 220	220	50	284	175x140	140x105	26x15	450
5107 DYR 250	250	60	320	175x140	140x105	26x15	500
5107 DYR 300	300	70	364	175x140	140x105	26x15	600
5107 DYR 350	350	80	412	175x140	140x105	26x15	650
5107 DYR 380	380	80	440	175x140	140x105	26x15	800









KYR		KAMALON KASNAK ÜZERİ VULKANİZE SİYAH LASTİK KAPLAMA RULMANLI					
KOD NO	 mm	 mm	 mm	 mm	 mm	 mm	 kg
5107 KYR 150	150	45	220	175x140	140x105	26x15	200
5107 KYR 160	160	50	225	175x140	140x105	26x15	240
5107 KYR 200	200	50	265	175x140	140x105	26x15	350
5107 KYR 250	250	50	320	175x140	140x105	26x15	500









KER		KAMALON KASNAK ÜZERİ VULKANİZE GRİ LASTİK KAPLAMA RULMANLI					
KOD NO	 mm	 mm	 mm	 mm	 mm	 mm	 kg
5107 KER 150	150	45	220	175x140	140x105	26x15	200
5107 KER 160	160	50	225	175x140	140x105	26x15	240
5107 KER 200	200	50	265	175x140	140x105	26x15	350
5107 KER 250	250	50	320	175x140	140x105	26x15	500









KUR		KAMALON KASNAK ÜZERİ ENJEKSİYON POLİÜRETAN KAPLAMA RULMANLI					
KOD NO	 mm	 mm	 mm	 mm	 mm	 mm	 kg
5107 KUR 150	150	50	220	175x140	140x105	26x15	550
5107 KUR 160	160	50	225	175x140	140x105	26x15	650
5107 KUR 200	200	50	265	175x140	140x105	26x15	800



K2UR		KAMALON KASNAK ÜZERİ OVAL ENJEKSİYON POLİÜRETAN KAPLAMA RULMANLI					
KOD NO	 mm	 mm	 mm	 mm	 mm	 mm	 kg
5107 K2UR 150	150	50	220	175x140	140x105	26x15	550
5107 K2UR 160	160	50	225	175x140	140x105	26x15	650
5107 K2UR 180	180	50	255	175x140	140x105	26x15	750
5107 K2UR 200	200	50	265	175x140	140x105	26x15	800









RPR		AĞIR TİP POLİAMİD TEKER RULMANLI						
KOD NO	 mm	 mm	 mm	 mm	 mm	 mm	 kg	
5107 RPR 150	150	45	220	175x140	140x105	26x15	600	
5107 RPR 200	200	50	265	175x140	140x105	26x15	900	
5107 RPR 250	250	60	320	175x140	140x105	26x15	1100	
5107 RPR 270	270	70	349	175x140	140x105	26x15	1400	



KPR		KAMALON KASNAK ÜZERİ POLİAMİD KAPLAMA RULMANLI						
KOD NO	 mm	 mm	 mm	 mm	 mm	 mm	 kg	
5107 KPR 150	150	50	220	175x140	140x105	26x15	700	
5107 KPR 160	160	50	225	175x140	140x105	26x15	800	
5107 KPR 200	200	50	265	175x140	140x105	26x15	1000	



K2PR		KAMALON KASNAK ÜZERİ OVAL POLİAMİD KAPLAMA RULMANLI						
KOD NO	 mm	 mm	 mm	 mm	 mm	 mm	 kg	
5107 K2PR 150	150	50	220	175x140	140x105	26x15	700	
5107 K2PR 160	160	50	225	175x140	140x105	26x15	800	
5107 K2PR 180	180	50	255	175x140	140x105	26x15	900	
5107 K2PR 200	200	50	265	175x140	140x105	26x15	1000	

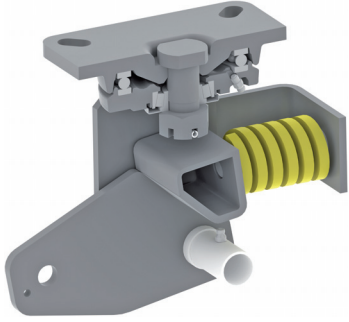

- A: DÖVME OYNAK TABLA
- B: BÜTE RULMAN
- C: DÖVME ÜST BİLYA ÇANAĞI
- D: TABLA ÇİVATASI
- E: KONİK RULMAN
- F: MAŞA AYAK KAYNAĞI
- G: METAL MUHAFAZA TOZLUK
- H: AYARLANABİLİR TAÇLI SOMUN
- I: YARIKLI PİM
- J: MAŞA AYAĞI
- K: YAY DESTEK SACI
- L: HAREKETLİ MAŞA AYAĞI
- M: GRESÖRLÜK
- N: YAY DESTEK SACI
- O: YAY TOPUZU
- P: AMORTİSÖR YAYI

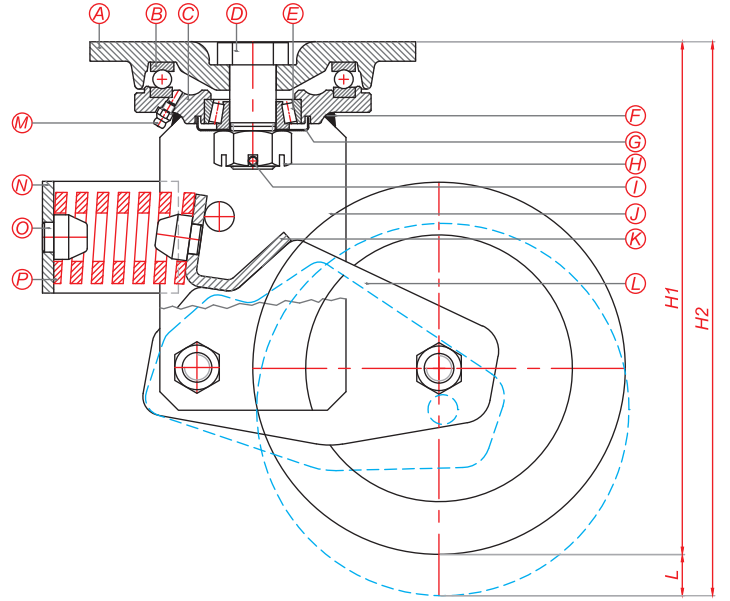

DDR

DÖKÜM TEKER RULMANLI

KOD NO	mm	mm	mm	mm	mm	mm	MAKSİMUM TAŞIMA KAPASİTESİ kg	ÖN GERME KUVVETİ kg	H2 TOPLAM YÜKSEKLİK mm	H1 YÜKLÜ TOPLAM YÜKSEKLİK mm	L YAY YOLU mm	YAYIN SON KUVVETİ kg
AY5102 DDR 200 M	200	50	100	175x140	140x105	26x15	1100	40	275	235	40	300
AY5102 DDR 200 K	200	50	100	175x140	140x105	26x15	1100	60	275	245	30	450
AY5102 DDR 200 S	200	50	100	175x140	140x105	26x15	1100	70	275	250	25	600
AY5102 DDR 250 M	250	50	120	175x140	140x105	26x15	1300	60	330	290	40	450
AY5102 DDR 250 K	250	50	120	175x140	140x105	26x15	1300	100	330	300	30	750
AY5102 DDR 250 S	250	50	120	175x140	140x105	26x15	1300	120	330	305	25	1000

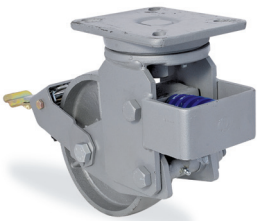







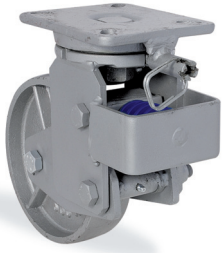

DDR

DÖKÜM TEKER RULMANLI

KOD NO	mm	mm	mm	mm	mm	mm	mm	MAKSİMUM TAŞIMA KAPASİTESİ kg	ÖN GERME KUVVETİ kg	H2 TOPLAM YÜKSEKLİK mm	H1 YÜKLÜ TOPLAM YÜKSEKLİK mm	L YAY YOLU mm	YAYIN SON KUVVETİ kg
AY5102 DDR 200 F04 M	200	50	100	353	175x140	140x105	26x15	1100	40	275	235	40	300
AY5102 DDR 200 F04 K	200	50	100	353	175x140	140x105	26x15	1100	60	275	245	30	450
AY5102 DDR 200 F04 S	200	50	100	353	175x140	140x105	26x15	1100	70	275	250	25	600
AY5102 DDR 250 F04 M	250	50	120	393	175x140	140x105	26x15	1300	60	330	290	40	450
AY5102 DDR 250 F04 K	250	50	120	393	175x140	140x105	26x15	1300	100	330	300	30	750
AY5102 DDR 250 F04 S	250	50	120	393	175x140	140x105	26x15	1300	120	330	305	25	1000

AY5102 Serisi (Amortisörlü)



DDR		DÖKÜM TEKER RULMANLI											
KOD NO								MAKSİMUM TAŞIMA KAPASİTESİ kg	ÖN GERME KUVVETİ kg	H2 TOPLAM YÜKSEKLİK mm	H1 YÜKLÜ TOPLAM YÜKSEKLİK mm	L YAY YOLU mm	YAYIN SON KUVVETİ kg
AY5102 DDR 200 F20 M	200	50	100	173	175x140	140x105	26x15	1100	40	275	235	40	300
AY5102 DDR 200 F20 K	200	50	100	173	175x140	140x105	26x15	1100	60	275	245	30	450
AY5102 DDR 200 F20 S	200	50	100	173	175x140	140x105	26x15	1100	70	275	250	25	600
AY5102 DDR 250 F20 M	250	50	120	173	175x140	140x105	26x15	1300	60	330	290	40	450
AY5102 DDR 250 F20 K	250	50	120	173	175x140	140x105	26x15	1300	100	330	300	30	750
AY5102 DDR 250 F20 S	250	50	120	173	175x140	140x105	26x15	1300	120	330	305	25	1000

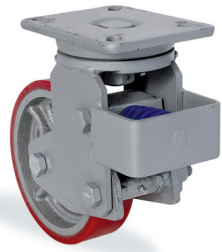

DOR		DÖKÜM KASNAK ÜZERİ DÖKME POLİÜRETAN KAPLAMA RULMANLI											
KOD NO								MAKSİMUM TAŞIMA KAPASİTESİ kg	ÖN GERME KUVVETİ kg	H2 TOPLAM YÜKSEKLİK mm	H1 YÜKLÜ TOPLAM YÜKSEKLİK mm	L YAY YOLU mm	YAYIN SON KUVVETİ kg
AY5102 DOR 200 M	200	50	100	175x140	140x105	26x15	1000	40	275	235	40	300	
AY5102 DOR 200 K	200	50	100	175x140	140x105	26x15	1000	60	275	245	30	450	
AY5102 DOR 200 S	200	50	100	175x140	140x105	26x15	1000	70	275	250	25	600	
AY5102 DOR 250 M	250	60	120	175x140	140x105	26x15	1350	60	330	290	40	450	
AY5102 DOR 250 K	250	60	120	175x140	140x105	26x15	1350	100	330	300	30	750	
AY5102 DOR 250 S	250	60	120	175x140	140x105	26x15	1350	120	330	305	25	1000	
AY5102 DOR 260 M	260	65	120	175x140	140x105	26x15	1400	60	335	295	40	450	
AY5102 DOR 260 K	260	65	120	175x140	140x105	26x15	1400	100	335	305	30	750	
AY5102 DOR 260 S	260	65	120	175x140	140x105	26x15	1400	120	335	310	25	1000	
AY5102 DOR 300 M	300	70	120	175x140	140x105	26x15	1600	60	395	355	40	450	
AY5102 DOR 300 K	300	70	120	175x140	140x105	26x15	1600	100	395	365	30	750	
AY5102 DOR 300 S	300	70	120	175x140	140x105	26x15	1600	120	395	370	25	1000	

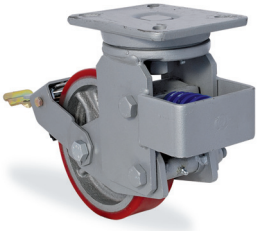



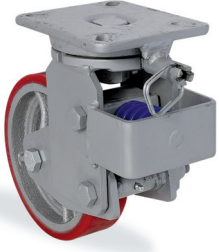



DOR		DÖKÜM KASNAK ÜZERİ DÖKME POLİÜRETAN KAPLAMA RULMANLI											
KOD NO								MAKSİMUM TAŞIMA KAPASİTESİ kg	ÖN GERME KUVVETİ kg	H2 TOPLAM YÜKSEKLİK mm	H1 YÜKLÜ TOPLAM YÜKSEKLİK mm	L YAY YOLU mm	YAYIN SON KUVVETİ kg
AY5102 DOR 200 F04 M	200	50	100	353	175x140	140x105	26x15	1000	40	275	235	40	300
AY5102 DOR 200 F04 K	200	50	100	353	175x140	140x105	26x15	1000	60	275	245	30	450
AY5102 DOR 200 F04 S	200	50	100	353	175x140	140x105	26x15	1000	70	275	250	25	600
AY5102 DOR 250 F04 M	250	60	120	393	175x140	140x105	26x15	1350	60	330	290	40	450
AY5102 DOR 250 F04 K	250	60	120	393	175x140	140x105	26x15	1350	100	330	300	30	750
AY5102 DOR 250 F04 S	250	60	120	393	175x140	140x105	26x15	1350	120	330	305	25	1000
AY5102 DOR 260 F04 M	260	65	120	393	175x140	140x105	26x15	1400	60	335	295	40	450
AY5102 DOR 260 F04 K	260	65	120	393	175x140	140x105	26x15	1400	100	335	305	30	750
AY5102 DOR 260 F04 S	260	65	120	393	175x140	140x105	26x15	1400	120	335	310	25	1000
AY5102 DOR 300 F04 M	300	70	120	418	175x140	140x105	26x15	1600	60	395	355	40	450
AY5102 DOR 300 F04 K	300	70	120	418	175x140	140x105	26x15	1600	100	395	365	30	750
AY5102 DOR 300 F04 S	300	70	120	418	175x140	140x105	26x15	1600	120	395	370	25	1000



DOR





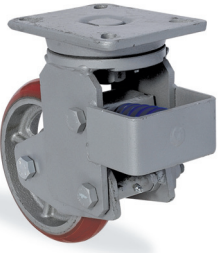

DÖKÜM KASNAK ÜZERİ DÖKME POLİÜRETAN KAPLAMA RULMANLI

KOD NO	 mm	 mm	 mm	 mm	 mm	 mm	MAKSİMUM TAŞIMA KAPASİTESİ kg	ÖN GERME KUVVETİ kg	H2 TOPLAM YÜKSEKLİK mm	H1 YÜKLÜ TOPLAM YÜKSEKLİK mm	L YAY YOLU mm	YAYIN SON KUVVETİ kg	
AY5102 DOR 200 F20 M	200	50	100	173	175x140	140x105	26x15	1000	40	275	235	40	300
AY5102 DOR 200 F20 K	200	50	100	173	175x140	140x105	26x15	1000	60	275	245	30	450
AY5102 DOR 200 F20 S	200	50	100	173	175x140	140x105	26x15	1000	70	275	250	25	600
AY5102 DOR 250 F20 M	250	60	120	173	175x140	140x105	26x15	1350	60	330	290	40	450
AY5102 DOR 250 F20 K	250	60	120	173	175x140	140x105	26x15	1350	100	330	300	30	750
AY5102 DOR 250 F20 S	250	60	120	173	175x140	140x105	26x15	1350	120	330	305	25	1000
AY5102 DOR 260 F20 M	260	65	120	173	175x140	140x105	26x15	1400	60	335	295	40	450
AY5102 DOR 260 F20 K	260	65	120	173	175x140	140x105	26x15	1400	100	335	305	30	750
AY5102 DOR 260 F20 S	260	65	120	173	175x140	140x105	26x15	1400	120	335	310	25	1000
AY5102 DOR 300 F20 M	300	70	120	173	175x140	140x105	26x15	1600	60	395	355	40	450
AY5102 DOR 300 F20 K	300	70	120	173	175x140	140x105	26x15	1600	100	395	365	30	750
AY5102 DOR 300 F20 S	300	70	120	173	175x140	140x105	26x15	1600	120	395	370	25	1000



D2OR

DÖKÜM KASNAK ÜZERİ OVAL DÖKME POLİÜRETAN KAPLAMA RULMANLI





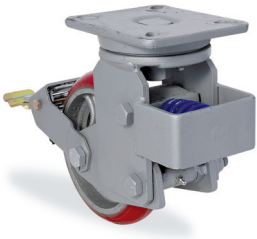

KOD NO	 mm	 mm	 mm	 mm	 mm	 mm	MAKSİMUM TAŞIMA KAPASİTESİ kg	ÖN GERME KUVVETİ kg	H2 TOPLAM YÜKSEKLİK mm	H1 YÜKLÜ TOPLAM YÜKSEKLİK mm	L YAY YOLU mm	YAYIN SON KUVVETİ kg
AY5102 D2OR 200 M	200	50	100	175x140	140x105	26x15	1000	40	275	235	40	300
AY5102 D2OR 200 K	200	50	100	175x140	140x105	26x15	1000	60	275	245	30	450
AY5102 D2OR 200 S	200	50	100	175x140	140x105	26x15	1000	70	275	250	25	600
AY5102 D2OR 250 M	250	60	120	175x140	140x105	26x15	1350	60	330	290	40	450
AY5102 D2OR 250 K	250	60	120	175x140	140x105	26x15	1350	100	330	300	30	750
AY5102 D2OR 250 S	250	60	120	175x140	140x105	26x15	1350	120	330	305	25	1000
AY5102 D2OR 260 M	260	65	120	175x140	140x105	26x15	1400	60	335	295	40	450
AY5102 D2OR 260 K	260	65	120	175x140	140x105	26x15	1400	100	335	305	30	750
AY5102 D2OR 260 S	260	65	120	175x140	140x105	26x15	1400	120	335	310	25	1000
AY5102 D2OR 300 M	300	70	120	175x140	140x105	26x15	1600	60	395	355	40	450
AY5102 D2OR 300 K	300	70	120	175x140	140x105	26x15	1600	100	395	365	30	750
AY5102 D2OR 300 S	300	70	120	175x140	140x105	26x15	1600	120	395	370	25	1000

AY5102 Serisi (Amortisörlü)



D2OR





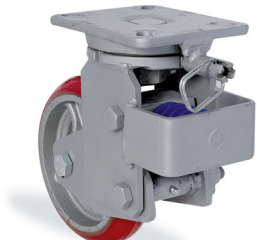

DÖKÜM KASNAK ÜZERİ OVAL DÖKME POLİÜRETAN KAPLAMA RULMANLI

KOD NO								MAKSİMUM TAŞIMA KAPASİTESİ kg	ÖN GERME KUVVETİ kg	H2 TOPLAM YÜKSEKLİK mm	H1 YÜKLÜ TOPLAM YÜKSEKLİK mm	L YAY YOLU mm	YAYIN SON KUVVETİ kg
AY5102 D2OR 200 F04 M	200	50	100	353	175x140	140x105	26x15	1000	40	275	235	40	300
AY5102 D2OR 200 F04 K	200	50	100	353	175x140	140x105	26x15	1000	60	275	245	30	450
AY5102 D2OR 200 F04 S	200	50	100	353	175x140	140x105	26x15	1000	70	275	250	25	600
AY5102 D2OR 250 F04 M	250	60	120	393	175x140	140x105	26x15	1350	60	330	290	40	450
AY5102 D2OR 250 F04 K	250	60	120	393	175x140	140x105	26x15	1350	100	330	300	30	750
AY5102 D2OR 250 F04 S	250	60	120	393	175x140	140x105	26x15	1350	120	330	305	25	1000
AY5102 D2OR 260 F04 M	260	65	120	393	175x140	140x105	26x15	1400	60	335	295	40	450
AY5102 D2OR 260 F04 K	260	65	120	393	175x140	140x105	26x15	1400	100	335	305	30	750
AY5102 D2OR 260 F04 S	260	65	120	393	175x140	140x105	26x15	1400	120	335	310	25	1000
AY5102 D2OR 300 F04 M	300	70	120	418	175x140	140x105	26x15	1600	60	395	355	40	450
AY5102 D2OR 300 F04 K	300	70	120	418	175x140	140x105	26x15	1600	100	395	365	30	750
AY5102 D2OR 300 F04 S	300	70	120	418	175x140	140x105	26x15	1600	120	395	370	25	1000



D2OR





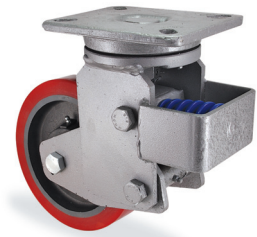

DÖKÜM KASNAK ÜZERİ OVAL DÖKME POLİÜRETAN KAPLAMA RULMANLI

KOD NO								MAKSİMUM TAŞIMA KAPASİTESİ kg	ÖN GERME KUVVETİ kg	H2 TOPLAM YÜKSEKLİK mm	H1 YÜKLÜ TOPLAM YÜKSEKLİK mm	L YAY YOLU mm	YAYIN SON KUVVETİ kg
AY5102 D2OR 200 F20 M	200	50	100	173	175x140	140x105	26x15	1000	40	275	235	40	300
AY5102 D2OR 200 F20 K	200	50	100	173	175x140	140x105	26x15	1000	60	275	245	30	450
AY5102 D2OR 200 F20 S	200	50	100	173	175x140	140x105	26x15	1000	70	275	250	25	600
AY5102 D2OR 250 F20 M	250	60	120	173	175x140	140x105	26x15	1350	60	330	290	40	450
AY5102 D2OR 250 F20 K	250	60	120	173	175x140	140x105	26x15	1350	100	330	300	30	750
AY5102 D2OR 250 F20 S	250	60	120	173	175x140	140x105	26x15	1350	120	330	305	25	1000
AY5102 D2OR 260 F20 M	260	65	120	173	175x140	140x105	26x15	1400	60	335	295	40	450
AY5102 D2OR 260 F20 K	260	65	120	173	175x140	140x105	26x15	1400	100	335	305	30	750
AY5102 D2OR 260 F20 S	260	65	120	173	175x140	140x105	26x15	1400	120	335	310	25	1000
AY5102 D2OR 300 F20 M	300	70	120	173	175x140	140x105	26x15	1600	60	395	355	40	450
AY5102 D2OR 300 F20 K	300	70	120	173	175x140	140x105	26x15	1600	100	395	365	30	750
AY5102 D2OR 300 F20 S	300	70	120	173	175x140	140x105	26x15	1600	120	395	370	25	1000



KOR

KAMALON KASNAK ÜZERİ DÖKME POLİÜRETAN KAPLAMA RULMANLI

KOD NO								MAKSİMUM TAŞIMA KAPASİTESİ kg	ÖN GERME KUVVETİ kg	H2 TOPLAM YÜKSEKLİK mm	H1 YÜKLÜ TOPLAM YÜKSEKLİK mm	L YAY YOLU mm	YAYIN SON KUVVETİ kg
AY5102 KOR 160 M	160	50	100	175x140	140x105	26x15	800	40	275	235	40	300	
AY5102 KOR 160 K	160	50	100	175x140	140x105	26x15	800	60	275	245	30	450	
AY5102 KOR 160 S	160	50	100	175x140	140x105	26x15	800	70	275	250	25	600	
AY5102 KOR 200 M	200	50	120	175x140	140x105	26x15	1000	40	275	235	40	300	
AY5102 KOR 200 K	200	50	120	175x140	140x105	26x15	1000	60	275	245	30	450	
AY5102 KOR 200 S	200	50	120	175x140	140x105	26x15	1000	70	275	250	25	600	
AY5102 KOR 250 M	250	50	120	175x140	140x105	26x15	1200	60	330	290	40	450	
AY5102 KOR 250 K	250	50	120	175x140	140x105	26x15	1200	100	330	300	30	750	
AY5102 KOR 250 S	250	50	120	175x140	140x105	26x15	1200	120	330	305	25	1000	



KOR		KAMALON KASNAK ÜZERİ DÖKME POLİÜRETAN KAPLAMA RULMANLI											
KOD NO								MAKSİMUM TAŞIMA KAPASİTESİ kg	ÖN GERME KUVVETİ kg	H2 TOPLAM YÜKSEKLİK mm	H1 YÜKLÜ TOPLAM YÜKSEKLİK mm	L YAY YOLU mm	YAYIN SON KUVVETİ kg
AY5102 KOR 160 F04 M	160	50	100	353	175x140	140x105	26x15	800	40	275	235	40	300
AY5102 KOR 160 F04 K	160	50	100	353	175x140	140x105	26x15	800	60	275	245	30	450
AY5102 KOR 160 F04 S	160	50	100	353	175x140	140x105	26x15	800	70	275	250	25	600
AY5102 KOR 200 F04 M	200	50	120	353	175x140	140x105	26x15	1000	40	275	235	40	300
AY5102 KOR 200 F04 K	200	50	120	353	175x140	140x105	26x15	1000	60	275	245	30	450
AY5102 KOR 200 F04 S	200	50	120	353	175x140	140x105	26x15	1000	70	275	250	25	600
AY5102 KOR 250 F04 M	250	50	120	393	175x140	140x105	26x15	1200	60	330	290	40	450
AY5102 KOR 250 F04 K	250	50	120	393	175x140	140x105	26x15	1200	100	330	300	30	750
AY5102 KOR 250 F04 S	250	50	120	393	175x140	140x105	26x15	1200	120	330	305	25	1000

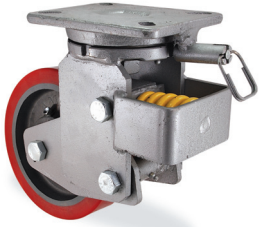





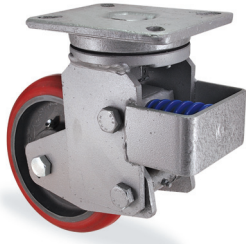

KOR		KAMALON KASNAK ÜZERİ DÖKME POLİÜRETAN KAPLAMA RULMANLI											
KOD NO								MAKSİMUM TAŞIMA KAPASİTESİ kg	ÖN GERME KUVVETİ kg	H2 TOPLAM YÜKSEKLİK mm	H1 YÜKLÜ TOPLAM YÜKSEKLİK mm	L YAY YOLU mm	YAYIN SON KUVVETİ kg
AY5102 KOR 160 F20 M	160	50	100	173	175x140	140x105	26x15	800	40	275	235	40	300
AY5102 KOR 160 F20 K	160	50	100	173	175x140	140x105	26x15	800	60	275	245	30	450
AY5102 KOR 160 F20 S	160	50	100	173	175x140	140x105	26x15	800	70	275	250	25	600
AY5102 KOR 200 F20 M	200	50	120	173	175x140	140x105	26x15	1000	40	275	235	40	300
AY5102 KOR 200 F20 K	200	50	120	173	175x140	140x105	26x15	1000	60	275	245	30	450
AY5102 KOR 200 F20 S	200	50	120	173	175x140	140x105	26x15	1000	70	275	250	25	600
AY5102 KOR 250 F20 M	250	50	120	173	175x140	140x105	26x15	1200	60	330	290	40	450
AY5102 KOR 250 F20 K	250	50	120	173	175x140	140x105	26x15	1200	100	330	300	30	750
AY5102 KOR 250 F20 S	250	50	120	173	175x140	140x105	26x15	1200	120	330	305	25	1000

AY5102 Serisi (Amortisörlü)



K2OR





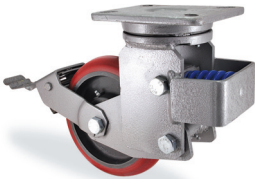

KAMALON KASNAK ÜZERİ OVAL DÖKME POLİÜRETAN KAPLAMA RULMANLI

KOD NO	 mm	 mm	 mm	 mm	 mm	 mm	MAKSİMUM TAŞIMA KAPASİTESİ kg	ÖN GERME KUVVETİ kg	H2 TOPLAM YÜKSEKLİK mm	H1 YÜKLÜ TOPLAM YÜKSEKLİK mm	L YAY YOLU mm	YAYIN SON KUVVETİ kg
AY5102 K2OR 160 M	160	50	100	175x140	140x105	26x15	800	40	275	235	40	300
AY5102 K2OR 160 K	160	50	100	175x140	140x105	26x15	800	60	275	245	30	450
AY5102 K2OR 160 S	160	50	100	175x140	140x105	26x15	800	70	275	250	25	600
AY5102 K2OR 200 M	200	50	120	175x140	140x105	26x15	1000	40	275	235	40	300
AY5102 K2OR 200 K	200	50	120	175x140	140x105	26x15	1000	60	275	245	30	450
AY5102 K2OR 200 S	200	50	120	175x140	140x105	26x15	1000	70	275	250	25	600
AY5102 K2OR 250 M	250	50	120	175x140	140x105	26x15	1200	60	330	290	40	450
AY5102 K2OR 250 K	250	50	120	175x140	140x105	26x15	1200	100	330	300	30	750
AY5102 K2OR 250 S	250	50	120	175x140	140x105	26x15	1200	120	330	305	25	1000



K2OR





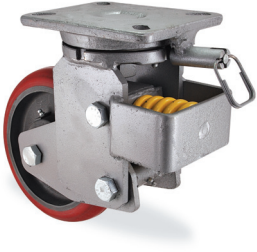

KAMALON KASNAK ÜZERİ OVAL DÖKME POLİÜRETAN KAPLAMA RULMANLI

KOD NO	 mm	 mm	 mm	 mm	 mm	 mm	 mm	MAKSİMUM TAŞIMA KAPASİTESİ kg	ÖN GERME KUVVETİ kg	H2 TOPLAM YÜKSEKLİK mm	H1 YÜKLÜ TOPLAM YÜKSEKLİK mm	L YAY YOLU mm	YAYIN SON KUVVETİ kg
AY5102 K2OR 160 F04 M	160	50	100	353	175x140	140x105	26x15	800	40	275	235	40	300
AY5102 K2OR 160 F04 K	160	50	100	353	175x140	140x105	26x15	800	60	275	245	30	450
AY5102 K2OR 160 F04 S	160	50	100	353	175x140	140x105	26x15	800	70	275	250	25	600
AY5102 K2OR 200 F04 M	200	50	120	353	175x140	140x105	26x15	1000	40	275	235	40	300
AY5102 K2OR 200 F04 K	200	50	120	353	175x140	140x105	26x15	1000	60	275	245	30	450
AY5102 K2OR 200 F04 S	200	50	120	353	175x140	140x105	26x15	1000	70	275	250	25	600
AY5102 K2OR 250 F04 M	250	50	120	393	175x140	140x105	26x15	1200	60	330	290	40	450
AY5102 K2OR 250 F04 K	250	50	120	393	175x140	140x105	26x15	1200	100	330	300	30	750
AY5102 K2OR 250 F04 S	250	50	120	393	175x140	140x105	26x15	1200	120	330	305	25	1000



K2OR







KAMALON KASNAK ÜZERİ OVAL DÖKME POLİÜRETAN KAPLAMA RULMANLI

KOD NO	 mm	 mm	 mm	 mm	 mm	 mm	MAKSİMUM TAŞIMA KAPASİTESİ kg	ÖN GERME KUVVETİ kg	H2 TOPLAM YÜKSEKLİK mm	H1 YÜKLÜ TOPLAM YÜKSEKLİK mm	L YAY YOLU mm	YAYIN SON KUVVETİ kg	
AY5102 K2OR 160 F20 M	160	50	100	173	175x140	140x105	26x15	800	40	275	235	40	300
AY5102 K2OR 160 F20 K	160	50	100	173	175x140	140x105	26x15	800	60	275	245	30	450
AY5102 K2OR 160 F20 S	160	50	100	173	175x140	140x105	26x15	800	70	275	250	25	600
AY5102 K2OR 200 F20 M	200	50	120	173	175x140	140x105	26x15	1000	40	275	235	40	300
AY5102 K2OR 200 F20 K	200	50	120	173	175x140	140x105	26x15	1000	60	275	245	30	450
AY5102 K2OR 200 F20 S	200	50	120	173	175x140	140x105	26x15	1000	70	275	250	25	600
AY5102 K2OR 250 F20 M	250	50	120	173	175x140	140x105	26x15	1200	60	330	290	40	450
AY5102 K2OR 250 F20 K	250	50	120	173	175x140	140x105	26x15	1200	100	330	300	30	750
AY5102 K2OR 250 F20 S	250	50	120	173	175x140	140x105	26x15	1200	120	330	305	25	1000



DYR

DÖKÜM KASNAK ÜZERİ VULKANİZE LASTİK KAPLAMA RULMANLI





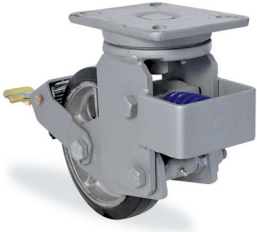

KOD NO	 mm	 mm	 mm	 mm	 mm	 mm	MAKSİMUM TAŞIMA KAPASİTESİ kg	ÖN GERME KUVVETİ kg	H2 TOPLAM YÜKSEKLİK mm	H1 YÜKLÜ TOPLAM YÜKSEKLİK mm	L YAY YOLU mm	YAYIN SON KUVVETİ kg
AY5102 DYR 200 M	200	50	100	175x140	140x105	26x15	350	40	275	235	40	300
AY5102 DYR 200 K	200	50	100	175x140	140x105	26x15	350	60	275	245	30	450
AY5102 DYR 200 S	200	50	100	175x140	140x105	26x15	350	70	275	250	25	600
AY5102 DYR 250 M	250	60	120	175x140	140x105	26x15	500	60	330	290	40	450
AY5102 DYR 250 K	250	60	120	175x140	140x105	26x15	500	100	330	300	30	750
AY5102 DYR 250 S	250	60	120	175x140	140x105	26x15	500	120	330	305	25	1000
AY5102 DYR 300 M	300	70	120	175x140	140x105	26x15	600	60	395	355	40	450
AY5102 DYR 300 K	300	70	120	175x140	140x105	26x15	600	100	395	365	30	750
AY5102 DYR 300 S	300	70	120	175x140	140x105	26x15	600	120	395	370	25	1000

AY5102 Serisi (Amortisörlü)



DYR





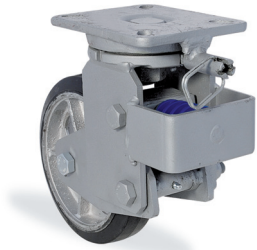

DÖKÜM KASNAK ÜZERİ VULKANİZE LASTİK KAPLAMA RULMANLI

KOD NO								MAKSİMUM TAŞIMA KAPASİTESİ kg	ÖN GERME KUVVETİ kg	H2 TOPLAM YÜKSEKLİK mm	H1 YÜKLÜ TOPLAM YÜKSEKLİK mm	L YAY YOLU mm	YAYIN SON KUVVETİ kg
AY5102 Dyr 200 F04 M	200	50	100	353	175x140	140x105	26x15	350	40	275	235	40	300
AY5102 Dyr 200 F04 K	200	50	100	353	175x140	140x105	26x15	350	60	275	245	30	450
AY5102 Dyr 200 F04 S	200	50	100	353	175x140	140x105	26x15	350	70	275	250	25	600
AY5102 Dyr 250 F04 M	250	60	120	393	175x140	140x105	26x15	500	60	330	290	40	450
AY5102 Dyr 250 F04 K	250	60	120	393	175x140	140x105	26x15	500	100	330	300	30	750
AY5102 Dyr 250 F04 S	250	60	120	393	175x140	140x105	26x15	500	120	330	305	25	1000
AY5102 Dyr 300 F04 M	300	70	120	418	175x140	140x105	26x15	600	60	395	355	40	450
AY5102 Dyr 300 F04 K	300	70	120	418	175x140	140x105	26x15	600	100	395	365	30	750
AY5102 Dyr 300 F04 S	300	70	120	418	175x140	140x105	26x15	600	120	395	370	25	1000



DYR

DÖKÜM KASNAK ÜZERİ VULKANİZE LASTİK KAPLAMA RULMANLI

KOD NO								MAKSİMUM TAŞIMA KAPASİTESİ kg	ÖN GERME KUVVETİ kg	H2 TOPLAM YÜKSEKLİK mm	H1 YÜKLÜ TOPLAM YÜKSEKLİK mm	L YAY YOLU mm	YAYIN SON KUVVETİ kg
AY5102 Dyr 200 F20 M	200	50	100	173	175x140	140x105	26x15	350	40	275	235	40	300
AY5102 Dyr 200 F20 K	200	50	100	173	175x140	140x105	26x15	350	60	275	245	30	450
AY5102 Dyr 200 F20 S	200	50	100	173	175x140	140x105	26x15	350	70	275	250	25	600
AY5102 Dyr 250 F20 M	250	60	120	173	175x140	140x105	26x15	500	60	330	290	40	450
AY5102 Dyr 250 F20 K	250	60	120	173	175x140	140x105	26x15	500	100	330	300	30	750
AY5102 Dyr 250 F20 S	250	60	120	173	175x140	140x105	26x15	500	120	330	305	25	1000
AY5102 Dyr 300 F20 M	300	70	120	173	175x140	140x105	26x15	600	60	395	355	40	450
AY5102 Dyr 300 F20 K	300	70	120	173	175x140	140x105	26x15	600	100	395	365	30	750
AY5102 Dyr 300 F20 S	300	70	120	173	175x140	140x105	26x15	600	120	395	370	25	1000

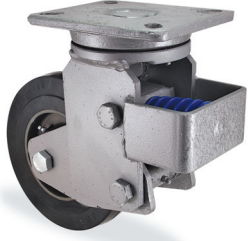

KYR		KAMALON KASNAK ÜZERİ VULKANİZE SİYAH LASTİK KAPLAMA RULMANLI										
KOD NO	 mm	 mm	 mm	 mm	 mm	 mm	MAKSİMUM TAŞIMA KAPASİTESİ kg	ÖN GERME KUVVETİ kg	H2 TOPLAM YÜKSEKLİK mm	H1 YÜKLÜ TOPLAM YÜKSEKLİK mm	L YAY YOLU mm	YAYIN SON KUVVETİ kg
AY5102 KYR 160 M	160	50	100	175x140	140x105	26x15	240	40	275	235	40	300
AY5102 KYR 160 K	160	50	100	175x140	140x105	26x15	240	60	275	245	30	450
AY5102 KYR 160 S	160	50	100	175x140	140x105	26x15	240	70	275	250	25	600
AY5102 KYR 200 M	200	50	100	175x140	140x105	26x15	350	40	275	235	40	300
AY5102 KYR 200 K	200	50	100	175x140	140x105	26x15	350	60	275	245	30	450
AY5102 KYR 200 S	200	50	100	175x140	140x105	26x15	350	70	275	250	25	600
AY5102 KYR 250 M	250	50	120	175x140	140x105	26x15	500	60	330	290	40	450
AY5102 KYR 250 K	250	50	120	175x140	140x105	26x15	500	100	330	300	30	750
AY5102 KYR 250 S	250	50	120	175x140	140x105	26x15	500	120	330	305	25	1000







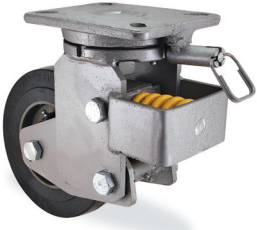

KYR		KAMALON KASNAK ÜZERİ VULKANİZE SİYAH LASTİK KAPLAMA RULMANLI											
KOD NO	 mm	 mm	 mm	 mm	 mm	 mm	MAKSİMUM TAŞIMA KAPASİTESİ kg	ÖN GERME KUVVETİ kg	H2 TOPLAM YÜKSEKLİK mm	H1 YÜKLÜ TOPLAM YÜKSEKLİK mm	L YAY YOLU mm	YAYIN SON KUVVETİ kg	
AY5102 KYR 160 F04 M	160	50	100	353	175x140	140x105	26x15	240	40	275	235	40	300
AY5102 KYR 160 F04 K	160	50	100	353	175x140	140x105	26x15	240	60	275	245	30	450
AY5102 KYR 160 F04 S	160	50	100	353	175x140	140x105	26x15	240	70	275	250	25	600
AY5102 KYR 200 F04 M	200	50	100	353	175x140	140x105	26x15	350	40	275	235	40	300
AY5102 KYR 200 F04 K	200	50	100	353	175x140	140x105	26x15	350	60	275	245	30	450
AY5102 KYR 200 F04 S	200	50	100	353	175x140	140x105	26x15	350	70	275	250	25	600
AY5102 KYR 250 F04 M	250	50	120	393	175x140	140x105	26x15	500	60	330	290	40	450
AY5102 KYR 250 F04 K	250	50	120	393	175x140	140x105	26x15	500	100	330	300	30	750
AY5102 KYR 250 F04 S	250	50	120	393	175x140	140x105	26x15	500	120	330	305	25	1000

AY5102 Serisi (Amortisörlü)



KYR





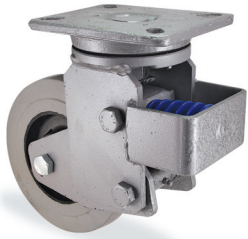

KAMALON KASNAK ÜZERİ VULKANİZE SİYAH LASTİK KAPLAMA RULMANLI

KOD NO	 mm	 mm	 mm	 mm	 mm	 mm	MAKSİMUM TAŞIMA KAPASİTESİ kg	ÖN GERME KUVVETİ kg	H2 TOPLAM YÜKSEKLİK mm	H1 YÜKLÜ TOPLAM YÜKSEKLİK mm	L YAY YOLU mm	YAYIN SON KUVVETİ kg	
AY5102 KYR 160 F20 M	160	50	100	173	175x140	140x105	26x15	240	40	275	235	40	300
AY5102 KYR 160 F20 K	160	50	100	173	175x140	140x105	26x15	240	60	275	245	30	450
AY5102 KYR 160 F20 S	160	50	100	173	175x140	140x105	26x15	240	70	275	250	25	600
AY5102 KYR 200 F20 M	200	50	100	173	175x140	140x105	26x15	350	40	275	235	40	300
AY5102 KYR 200 F20 K	200	50	100	173	175x140	140x105	26x15	350	60	275	245	30	450
AY5102 KYR 200 F20 S	200	50	100	173	175x140	140x105	26x15	350	70	275	250	25	600
AY5102 KYR 250 F20 M	250	50	120	173	175x140	140x105	26x15	500	60	330	290	40	450
AY5102 KYR 250 F20 K	250	50	120	173	175x140	140x105	26x15	500	100	330	300	30	750
AY5102 KYR 250 F20 S	250	50	120	173	175x140	140x105	26x15	500	120	330	305	25	1000



KER



KAMALON KASNAK ÜZERİ VULKANİZE GRİ LASTİK KAPLAMA RULMANLI

KOD NO	 mm	 mm	 mm	 mm	 mm	 mm	MAKSİMUM TAŞIMA KAPASİTESİ kg	ÖN GERME KUVVETİ kg	H2 TOPLAM YÜKSEKLİK mm	H1 YÜKLÜ TOPLAM YÜKSEKLİK mm	L YAY YOLU mm	YAYIN SON KUVVETİ kg
AY5102 KER 160 M	160	50	100	175x140	140x105	26x15	240	40	275	235	40	300
AY5102 KER 160 K	160	50	100	175x140	140x105	26x15	240	60	275	245	30	450
AY5102 KER 160 S	160	50	100	175x140	140x105	26x15	240	70	275	250	25	600
AY5102 KER 200 M	200	50	100	175x140	140x105	26x15	350	40	275	235	40	300
AY5102 KER 200 K	200	50	100	175x140	140x105	26x15	350	60	275	245	30	450
AY5102 KER 200 S	200	50	100	175x140	140x105	26x15	350	70	275	250	25	600
AY5102 KER 250 M	250	50	120	175x140	140x105	26x15	500	60	330	290	40	450
AY5102 KER 250 K	250	50	120	175x140	140x105	26x15	500	100	330	300	30	750
AY5102 KER 250 S	250	50	120	175x140	140x105	26x15	500	120	330	305	25	1000

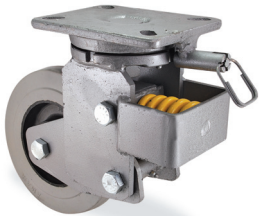

KER		KAMALON KASNAK ÜZERİ VULKANİZE GRİ LASTİK KAPLAMA RULMANLI											
KOD NO								MAKSİMUM TAŞIMA KAPASİTESİ kg	ÖN GERME KUVVETİ kg	H2 TOPLAM YÜKSEKLİK mm	H1 YÜKLÜ TOPLAM YÜKSEKLİK mm	L YAY YOLU mm	YAYIN SON KUVVETİ kg
AY5102 KER 160 F04 M	160	50	100	353	175x140	140x105	26x15	240	40	275	235	40	300
AY5102 KER 160 F04 K	160	50	100	353	175x140	140x105	26x15	240	60	275	245	30	450
AY5102 KER 160 F04 S	160	50	100	353	175x140	140x105	26x15	240	70	275	250	25	600
AY5102 KER 200 F04 M	200	50	100	353	175x140	140x105	26x15	350	40	275	235	40	300
AY5102 KER 200 F04 K	200	50	100	353	175x140	140x105	26x15	350	60	275	245	30	450
AY5102 KER 200 F04 S	200	50	100	353	175x140	140x105	26x15	350	70	275	250	25	600
AY5102 KER 250 F04 M	250	50	120	393	175x140	140x105	26x15	500	60	330	290	40	450
AY5102 KER 250 F04 K	250	50	120	393	175x140	140x105	26x15	500	100	330	300	30	750
AY5102 KER 250 F04 S	250	50	120	393	175x140	140x105	26x15	500	120	330	305	25	1000



KER		KAMALON KASNAK ÜZERİ VULKANİZE GRİ LASTİK KAPLAMA RULMANLI											
KOD NO								MAKSİMUM TAŞIMA KAPASİTESİ kg	ÖN GERME KUVVETİ kg	H2 TOPLAM YÜKSEKLİK mm	H1 YÜKLÜ TOPLAM YÜKSEKLİK mm	L YAY YOLU mm	YAYIN SON KUVVETİ kg
AY5102 KER 160 F20 M	160	50	100	173	175x140	140x105	26x15	240	40	275	235	40	300
AY5102 KER 160 F20 K	160	50	100	173	175x140	140x105	26x15	240	60	275	245	30	450
AY5102 KER 160 F20 S	160	50	100	173	175x140	140x105	26x15	240	70	275	250	25	600
AY5102 KER 200 F20 M	200	50	100	173	175x140	140x105	26x15	350	40	275	235	40	300
AY5102 KER 200 F20 K	200	50	100	173	175x140	140x105	26x15	350	60	275	245	30	450
AY5102 KER 200 F20 S	200	50	100	173	175x140	140x105	26x15	350	70	275	250	25	600
AY5102 KER 250 F20 M	250	50	120	173	175x140	140x105	26x15	500	60	330	290	40	450
AY5102 KER 250 F20 K	250	50	120	173	175x140	140x105	26x15	500	100	330	300	30	750
AY5102 KER 250 F20 S	250	50	120	173	175x140	140x105	26x15	500	120	330	305	25	1000

AY5102 Serisi (Amortisörlü)



KUR		KAMALON KASNAK ÜZERİ ENJEKSİYON POLİÜRETAN KAPLAMA RULMANLI										
KOD NO							MAKSİMUM TAŞIMA KAPASİTESİ kg	ÖN GERME KUVVETİ kg	H2 TOPLAM YÜKSEKLİK mm	H1 YÜKLÜ TOPLAM YÜKSEKLİK mm	L YAY YOLU mm	YAYIN SON KUVVETİ kg
AY5102 KUR 160 M	160	50	100	175x140	140x105	26x15	650	40	275	235	40	300
AY5102 KUR 160 K	160	50	100	175x140	140x105	26x15	650	60	275	245	30	450
AY5102 KUR 160 S	160	50	100	175x140	140x105	26x15	650	70	275	250	25	600
AY5102 KUR 200 M	200	50	100	175x140	140x105	26x15	800	40	275	235	40	300
AY5102 KUR 200 K	200	50	100	175x140	140x105	26x15	800	60	275	245	30	450
AY5102 KUR 200 S	200	50	100	175x140	140x105	26x15	800	70	275	250	25	600

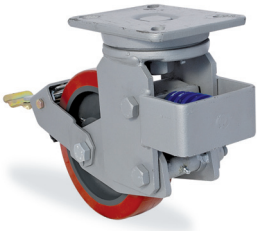

KUR		KAMALON KASNAK ÜZERİ ENJEKSİYON POLİÜRETAN KAPLAMA RULMANLI											
KOD NO							MAKSİMUM TAŞIMA KAPASİTESİ kg	ÖN GERME KUVVETİ kg	H2 TOPLAM YÜKSEKLİK mm	H1 YÜKLÜ TOPLAM YÜKSEKLİK mm	L YAY YOLU mm	YAYIN SON KUVVETİ kg	
AY5102 KUR 160 F04 M	160	50	100	353	175x140	140x105	26x15	650	40	275	235	40	300
AY5102 KUR 160 F04 K	160	50	100	353	175x140	140x105	26x15	650	60	275	245	30	450
AY5102 KUR 160 F04 S	160	50	100	353	175x140	140x105	26x15	650	70	275	250	25	600
AY5102 KUR 200 F04 M	200	50	100	353	175x140	140x105	26x15	800	40	275	235	40	300
AY5102 KUR 200 F04 K	200	50	100	353	175x140	140x105	26x15	800	60	275	245	30	450
AY5102 KUR 200 F04 S	200	50	100	353	175x140	140x105	26x15	800	70	275	250	25	600

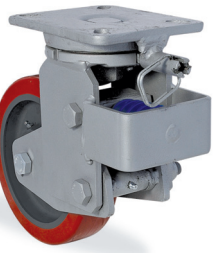



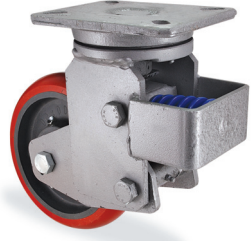



KUR		KAMALON KASNAK ÜZERİ ENJEKSİYON POLİÜRETAN KAPLAMA RULMANLI											
KOD NO							MAKSİMUM TAŞIMA KAPASİTESİ kg	ÖN GERME KUVVETİ kg	H2 TOPLAM YÜKSEKLİK mm	H1 YÜKLÜ TOPLAM YÜKSEKLİK mm	L YAY YOLU mm	YAYIN SON KUVVETİ kg	
AY5102 KUR 160 F20 M	160	50	100	173	175x140	140x105	26x15	650	40	275	235	40	300
AY5102 KUR 160 F20 K	160	50	100	173	175x140	140x105	26x15	650	60	275	245	30	450
AY5102 KUR 160 F20 S	160	50	100	173	175x140	140x105	26x15	650	70	275	250	25	600
AY5102 KUR 200 F20 M	200	50	100	173	175x140	140x105	26x15	800	40	275	235	40	300
AY5102 KUR 200 F20 K	200	50	100	173	175x140	140x105	26x15	800	60	275	245	30	450
AY5102 KUR 200 F20 S	200	50	100	173	175x140	140x105	26x15	800	70	275	250	25	600



K2UR





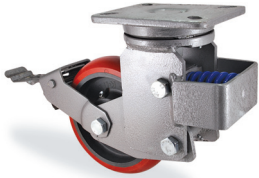

KAMALON KASNAK ÜZERİ OVAL ENJEKSİYON POLİÜRETAN KAPLAMA RULMANLI

KOD NO	 mm	 mm	 mm	 mm	 mm	 mm	MAKSİMUM TAŞIMA KAPASİTESİ kg	ÖN GERME KUVVETİ kg	H2 TOPLAM YÜKSEKLİK mm	H1 YÜKLÜ TOPLAM YÜKSEKLİK mm	L YAY YOLU mm	YAYIN SON KUVVETİ kg
AY5102 K2UR 160 M	160	50	100	175x140	140x105	26x15	650	40	275	235	40	300
AY5102 K2UR 160 K	160	50	100	175x140	140x105	26x15	650	60	275	245	30	450
AY5102 K2UR 160 S	160	50	100	175x140	140x105	26x15	650	70	275	250	25	600
AY5102 K2UR 200 M	200	50	100	175x140	140x105	26x15	800	40	275	235	40	300
AY5102 K2UR 200 K	200	50	100	175x140	140x105	26x15	800	60	275	245	30	450
AY5102 K2UR 200 S	200	50	100	175x140	140x105	26x15	800	70	275	250	25	600



K2UR





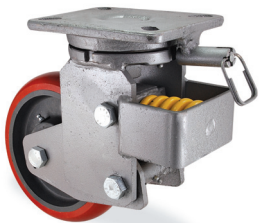

KAMALON KASNAK ÜZERİ OVAL ENJEKSİYON POLİÜRETAN KAPLAMA RULMANLI

KOD NO	 mm	 mm	 mm	 mm	 mm	 mm	MAKSİMUM TAŞIMA KAPASİTESİ kg	ÖN GERME KUVVETİ kg	H2 TOPLAM YÜKSEKLİK mm	H1 YÜKLÜ TOPLAM YÜKSEKLİK mm	L YAY YOLU mm	YAYIN SON KUVVETİ kg	
AY5102 K2UR 160 F04 M	160	50	100	353	175x140	140x105	26x15	650	40	275	235	40	300
AY5102 K2UR 160 F04 K	160	50	100	353	175x140	140x105	26x15	650	60	275	245	30	450
AY5102 K2UR 160 F04 S	160	50	100	353	175x140	140x105	26x15	650	70	275	250	25	600
AY5102 K2UR 200 F04 M	200	50	100	353	175x140	140x105	26x15	800	40	275	235	40	300
AY5102 K2UR 200 F04 K	200	50	100	353	175x140	140x105	26x15	800	60	275	245	30	450
AY5102 K2UR 200 F04 S	200	50	100	353	175x140	140x105	26x15	800	70	275	250	25	600







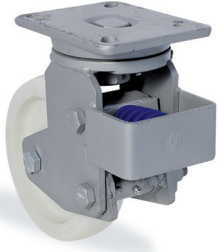

K2UR

KAMALON KASNAK ÜZERİ OVAL ENJEKSİYON POLİÜRETAN KAPLAMA RULMANLI





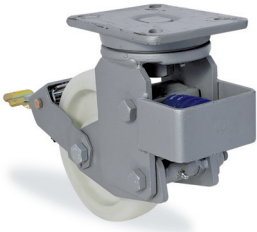

KOD NO	 mm	 mm	 mm	 mm	 mm	 mm	MAKSİMUM TAŞIMA KAPASİTESİ kg	ÖN GERME KUVVETİ kg	H2 TOPLAM YÜKSEKLİK mm	H1 YÜKLÜ TOPLAM YÜKSEKLİK mm	L YAY YOLU mm	YAYIN SON KUVVETİ kg	
AY5102 K2UR 160 F20 M	160	50	100	173	175x140	140x105	26x15	650	40	275	235	40	300
AY5102 K2UR 160 F20 K	160	50	100	173	175x140	140x105	26x15	650	60	275	245	30	450
AY5102 K2UR 160 F20 S	160	50	100	173	175x140	140x105	26x15	650	70	275	250	25	600
AY5102 K2UR 200 F20 M	200	50	100	173	175x140	140x105	26x15	800	40	275	235	40	300
AY5102 K2UR 200 F20 K	200	50	100	173	175x140	140x105	26x15	800	60	275	245	30	450
AY5102 K2UR 200 F20 S	200	50	100	173	175x140	140x105	26x15	800	70	275	250	25	600

AY5102 Serisi (Amortisörlü)







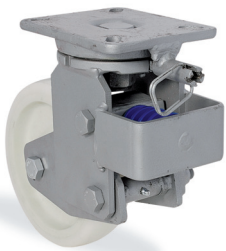

RPR		AĞIR TİP POLİAMİD TEKER RULMANLI										
KOD NO							MAKSİMUM TAŞIMA KAPASİTESİ kg	ÖN GERME KUVVETİ kg	H2 TOPLAM YÜKSEKLİK mm	H1 YÜKLÜ TOPLAM YÜKSEKLİK mm	L YAY YOLU mm	YAYIN SON KUVVETİ kg
AY5102 RPR 200 M	200	50	100	175x140	140x105	26x15	900	40	275	235	40	300
AY5102 RPR 200 K	200	50	100	175x140	140x105	26x15	900	60	275	245	30	450
AY5102 RPR 200 S	200	50	100	175x140	140x105	26x15	900	70	275	250	25	600
AY5102 RPR 250 M	250	60	120	175x140	140x105	26x15	1100	60	330	290	40	450
AY5102 RPR 250 K	250	60	120	175x140	140x105	26x15	1100	100	330	300	30	750
AY5102 RPR 250 S	250	60	120	175x140	140x105	26x15	1100	120	330	305	25	1000
AY5102 RPR 300 M	300	70	120	175x140	140x105	26x15	1400	60	395	355	40	450
AY5102 RPR 300 K	300	70	120	175x140	140x105	26x15	1400	100	395	365	30	750
AY5102 RPR 300 S	300	70	120	175x140	140x105	26x15	1400	120	395	370	25	1000



RPR		AĞIR TİP POLİAMİD TEKER RULMANLI											
KOD NO							MAKSİMUM TAŞIMA KAPASİTESİ kg	ÖN GERME KUVVETİ kg	H2 TOPLAM YÜKSEKLİK mm	H1 YÜKLÜ TOPLAM YÜKSEKLİK mm	L YAY YOLU mm	YAYIN SON KUVVETİ kg	
AY5102 RPR 200 F04 M	200	50	100	353	175x140	140x105	26x15	900	40	275	235	40	300
AY5102 RPR 200 F04 K	200	50	100	353	175x140	140x105	26x15	900	60	275	245	30	450
AY5102 RPR 200 F04 S	200	50	100	353	175x140	140x105	26x15	900	70	275	250	25	600
AY5102 RPR 250 F04 M	250	60	120	393	175x140	140x105	26x15	1100	60	330	290	40	450
AY5102 RPR 250 F04 K	250	60	120	393	175x140	140x105	26x15	1100	100	330	300	30	750
AY5102 RPR 250 F04 S	250	60	120	393	175x140	140x105	26x15	1100	120	330	305	25	1000
AY5102 RPR 300 F04 M	300	70	120	418	175x140	140x105	26x15	1400	60	395	355	40	450
AY5102 RPR 300 F04 K	300	70	120	418	175x140	140x105	26x15	1400	100	395	365	30	750
AY5102 RPR 300 F04 S	300	70	120	418	175x140	140x105	26x15	1400	120	395	370	25	1000





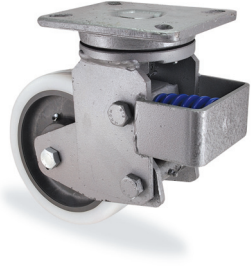



RPR		AĞIR TİP POLİAMİD TEKER RULMANLI											
KOD NO							MAKSİMUM TAŞIMA KAPASİTESİ kg	ÖN GERME KUVVETİ kg	H2 TOPLAM YÜKSEKLİK mm	H1 YÜKLÜ TOPLAM YÜKSEKLİK mm	L YAY YOLU mm	YAYIN SON KUVVETİ kg	
AY5102 RPR 200 F20 M	200	50	100	173	175x140	140x105	26x15	900	40	275	235	40	300
AY5102 RPR 200 F20 K	200	50	100	173	175x140	140x105	26x15	900	60	275	245	30	450
AY5102 RPR 200 F20 S	200	50	100	173	175x140	140x105	26x15	900	70	275	250	25	600
AY5102 RPR 250 F20 M	250	60	120	173	175x140	140x105	26x15	1100	60	330	290	40	450
AY5102 RPR 250 F20 K	250	60	120	173	175x140	140x105	26x15	1100	100	330	300	30	750
AY5102 RPR 250 F20 S	250	60	120	173	175x140	140x105	26x15	1100	120	330	305	25	1000
AY5102 RPR 300 F20 M	300	70	120	173	175x140	140x105	26x15	1400	60	395	355	40	450
AY5102 RPR 300 F20 K	300	70	120	173	175x140	140x105	26x15	1400	100	395	365	30	750
AY5102 RPR 300 F20 S	300	70	120	173	175x140	140x105	26x15	1400	120	395	370	25	1000



KPR		KAMALON KASNAK ÜZERİ POLİAMİD KAPLAMA RULMANLI										
KOD NO							MAKSİMUM TAŞIMA KAPASİTESİ kg	ÖN GERME KUVVETİ kg	H2 TOPLAM YÜKSEKLİK mm	H1 YÜKLÜ TOPLAM YÜKSEKLİK mm	L YAY YOLU mm	YAYIN SON KUVVETİ kg
AY5102 KPR 160 M	160	50	100	175x140	140x105	26x15	800	40	275	235	40	300
AY5102 KPR 160 K	160	50	100	175x140	140x105	26x15	800	60	275	245	30	450
AY5102 KPR 160 S	160	50	100	175x140	140x105	26x15	800	70	275	250	25	600
AY5102 KPR 200 M	200	50	100	175x140	140x105	26x15	1000	40	275	235	40	300
AY5102 KPR 200 K	200	50	100	175x140	140x105	26x15	1000	60	275	245	30	450
AY5102 KPR 200 S	200	50	100	175x140	140x105	26x15	1000	70	275	250	25	600



KPR		KAMALON KASNAK ÜZERİ POLİAMİD KAPLAMA RULMANLI											
KOD NO							MAKSİMUM TAŞIMA KAPASİTESİ kg	ÖN GERME KUVVETİ kg	H2 TOPLAM YÜKSEKLİK mm	H1 YÜKLÜ TOPLAM YÜKSEKLİK mm	L YAY YOLU mm	YAYIN SON KUVVETİ kg	
AY5102 KPR 160 F04 M	160	50	100	353	175x140	140x105	26x15	800	40	275	235	40	300
AY5102 KPR 160 F04 K	160	50	100	353	175x140	140x105	26x15	800	60	275	245	30	450
AY5102 KPR 160 F04 S	160	50	100	353	175x140	140x105	26x15	800	70	275	250	25	600
AY5102 KPR 200 F04 M	200	50	100	353	175x140	140x105	26x15	1000	40	275	235	40	300
AY5102 KPR 200 F04 K	200	50	100	353	175x140	140x105	26x15	1000	60	275	245	30	450
AY5102 KPR 200 F04 S	200	50	100	353	175x140	140x105	26x15	1000	70	275	250	25	600

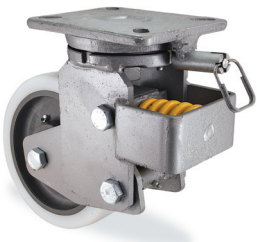





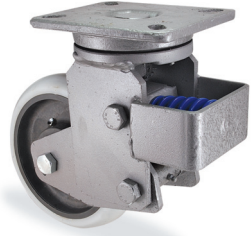

KPR		KAMALON KASNAK ÜZERİ POLİAMİD KAPLAMA RULMANLI											
KOD NO							MAKSİMUM TAŞIMA KAPASİTESİ kg	ÖN GERME KUVVETİ kg	H2 TOPLAM YÜKSEKLİK mm	H1 YÜKLÜ TOPLAM YÜKSEKLİK mm	L YAY YOLU mm	YAYIN SON KUVVETİ kg	
AY5102 KPR 160 F20 M	160	50	100	173	175x140	140x105	26x15	800	40	275	235	40	300
AY5102 KPR 160 F20 K	160	50	100	173	175x140	140x105	26x15	800	60	275	245	30	450
AY5102 KPR 160 F20 S	160	50	100	173	175x140	140x105	26x15	800	70	275	250	25	600
AY5102 KPR 200 F20 M	200	50	100	173	175x140	140x105	26x15	1000	40	275	235	40	300
AY5102 KPR 200 F20 K	200	50	100	173	175x140	140x105	26x15	1000	60	275	245	30	450
AY5102 KPR 200 F20 S	200	50	100	173	175x140	140x105	26x15	1000	70	275	250	25	600

AY5102 Serisi (Amortisörlü)



K2PR







KAMALON KASNAK ÜZERİ OVAL POLİAMİD KAPLAMA RULMANLI

KOD NO	 mm	 mm	 mm	 mm	 mm	 mm	MAKSİMUM TAŞIMA KAPASİTESİ kg	ÖN GERME KUVVETİ kg	H2 TOPLAM YÜKSEKLİK mm	H1 YÜKLÜ TOPLAM YÜKSEKLİK mm	L YAY YOLU mm	YAYIN SON KUVVETİ kg
AY5102 K2PR 160 M	160	50	100	175x140	140x105	26x15	800	40	275	235	40	300
AY5102 K2PR 160 K	160	50	100	175x140	140x105	26x15	800	60	275	245	30	450
AY5102 K2PR 160 S	160	50	100	175x140	140x105	26x15	800	70	275	250	25	600
AY5102 K2PR 200 M	200	50	100	175x140	140x105	26x15	1000	40	275	235	40	300
AY5102 K2PR 200 K	200	50	100	175x140	140x105	26x15	1000	60	275	245	30	450
AY5102 K2PR 200 S	200	50	100	175x140	140x105	26x15	1000	70	275	250	25	600



K2PR





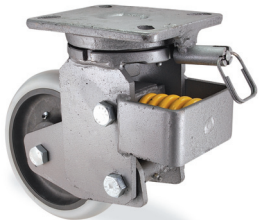

KAMALON KASNAK ÜZERİ OVAL POLİAMİD KAPLAMA RULMANLI

KOD NO	 mm	 mm	 mm	 mm	 mm	 mm	MAKSİMUM TAŞIMA KAPASİTESİ kg	ÖN GERME KUVVETİ kg	H2 TOPLAM YÜKSEKLİK mm	H1 YÜKLÜ TOPLAM YÜKSEKLİK mm	L YAY YOLU mm	YAYIN SON KUVVETİ kg	
AY5102 K2PR 160 F04 M	160	50	100	353	175x140	140x105	26x15	800	40	275	235	40	300
AY5102 K2PR 160 F04 K	160	50	100	353	175x140	140x105	26x15	800	60	275	245	30	450
AY5102 K2PR 160 F04 S	160	50	100	353	175x140	140x105	26x15	800	70	275	250	25	600
AY5102 K2PR 200 F04 M	200	50	100	353	175x140	140x105	26x15	1000	40	275	235	40	300
AY5102 K2PR 200 F04 K	200	50	100	353	175x140	140x105	26x15	1000	60	275	245	30	450
AY5102 K2PR 200 F04 S	200	50	100	353	175x140	140x105	26x15	1000	70	275	250	25	600



K2PR

KAMALON KASNAK ÜZERİ OVAL POLİAMİD KAPLAMA RULMANLI

KOD NO	 mm	 mm	 mm	 mm	 mm	 mm	MAKSİMUM TAŞIMA KAPASİTESİ kg	ÖN GERME KUVVETİ kg	H2 TOPLAM YÜKSEKLİK mm	H1 YÜKLÜ TOPLAM YÜKSEKLİK mm	L YAY YOLU mm	YAYIN SON KUVVETİ kg	
AY5102 K2PR 160 F20 M	160	50	100	173	175x140	140x105	26x15	800	40	275	235	40	300
AY5102 K2PR 160 F20 K	160	50	100	173	175x140	140x105	26x15	800	60	275	245	30	450
AY5102 K2PR 160 F20 S	160	50	100	173	175x140	140x105	26x15	800	70	275	250	25	600
AY5102 K2PR 200 F20 M	200	50	100	173	175x140	140x105	26x15	1000	40	275	235	40	300
AY5102 K2PR 200 F20 K	200	50	100	173	175x140	140x105	26x15	1000	60	275	245	30	450
AY5102 K2PR 200 F20 S	200	50	100	173	175x140	140x105	26x15	1000	70	275	250	25	600

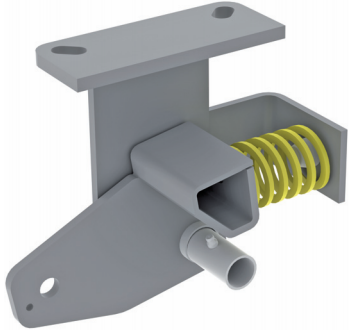

- A:** DÖVME SABİT TABLA
- B:** MAŞA AYAĞI
- C:** MAŞA AYAK KAYNAĞI
- D:** YAY DESTEK SACI
- E:** HAREKETLİ MAŞA AYAĞI
- F:** YAY DESTEK SACI
- G:** YAY TOPUZU
- H:** AMORTİSÖR YAYI

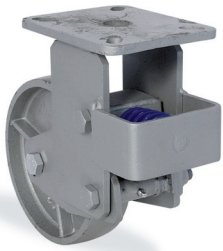
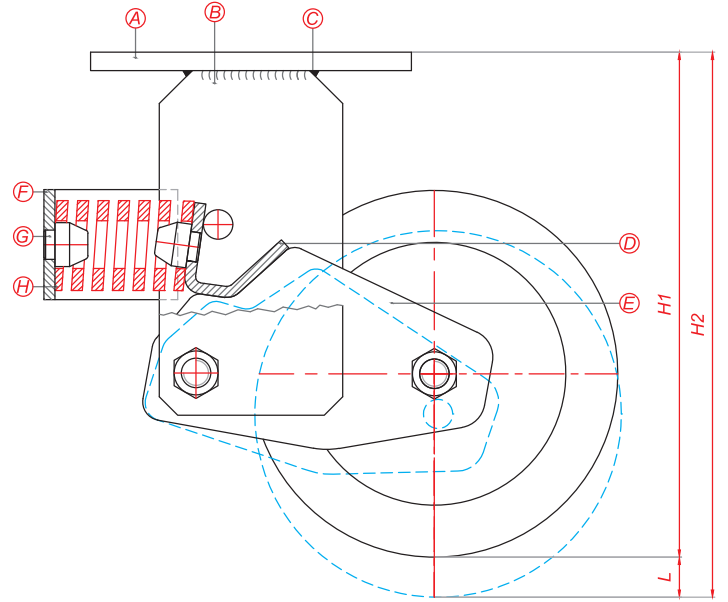

DDR

DÖKÜM TEKER RULMANLI

KOD NO	mm	mm	mm	mm	mm	mm	MAKSİMUM TAŞIMA KAPASİTESİ kg	ÖN GERME KUVVETİ kg	H2 TOPLAM YÜKSEKLİK mm	H1 YÜKLÜ TOPLAM YÜKSEKLİK mm	L YAY YOLU mm	YAYIN SON KUVVETİ kg
AY5107 DDR 200 M	200	50	100	175x140	140x105	26x15	1100	40	275	235	40	300
AY5107 DDR 200 K	200	50	100	175x140	140x105	26x15	1100	60	275	245	30	450
AY5107 DDR 200 S	200	50	100	175x140	140x105	26x15	1100	70	275	250	25	600
AY5107 DDR 250 M	250	50	120	175x140	140x105	26x15	1300	60	330	290	40	450
AY5107 DDR 250 K	250	50	120	175x140	140x105	26x15	1300	100	330	300	30	750
AY5107 DDR 250 S	250	50	120	175x140	140x105	26x15	1300	120	330	305	25	1000

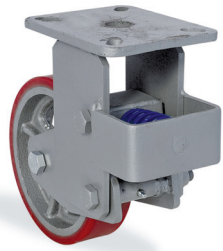

DOR

DÖKÜM KASNAK ÜZERİ DÖKME POLİÜRETAN KAPLAMA RULMANLI





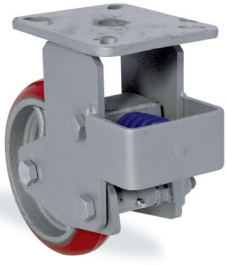

KOD NO	mm	mm	mm	mm	mm	mm	MAKSİMUM TAŞIMA KAPASİTESİ kg	ÖN GERME KUVVETİ kg	H2 TOPLAM YÜKSEKLİK mm	H1 YÜKLÜ TOPLAM YÜKSEKLİK mm	L YAY YOLU mm	YAYIN SON KUVVETİ kg
AY5107 DOR 200 M	200	50	100	175x140	140x105	26x15	1000	40	275	235	40	300
AY5107 DOR 200 K	200	50	100	175x140	140x105	26x15	1000	60	275	245	30	450
AY5107 DOR 200 S	200	50	100	175x140	140x105	26x15	1000	70	275	250	25	600
AY5107 DOR 250 M	250	60	120	175x140	140x105	26x15	1350	60	330	290	40	450
AY5107 DOR 250 K	250	60	120	175x140	140x105	26x15	1350	100	330	300	30	750
AY5107 DOR 250 S	250	60	120	175x140	140x105	26x15	1350	120	330	305	25	1000
AY5107 DOR 260 M	260	65	120	175x140	140x105	26x15	1400	60	335	295	40	450
AY5107 DOR 260 K	260	65	120	175x140	140x105	26x15	1400	100	335	305	30	750
AY5107 DOR 260 S	260	65	120	175x140	140x105	26x15	1400	120	335	310	25	1000
AY5107 DOR 300 M	300	70	120	175x140	140x105	26x15	1600	60	395	355	40	450
AY5107 DOR 300 K	300	70	120	175x140	140x105	26x15	1600	100	395	365	30	750
AY5107 DOR 300 S	300	70	120	175x140	140x105	26x15	1600	120	395	370	25	1000

AY5107 Serisi (Amortisörlü)



D2OR





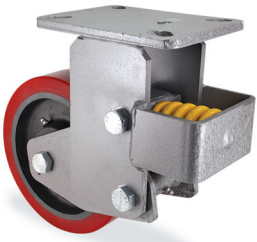

DÖKÜM KASNAK ÜZERİ OVAL DÖKME POLİÜRETAN KAPLAMA RULMANLI

KOD NO	 mm	 mm	 mm	 mm	 mm	 mm	MAKSİMUM TAŞIMA KAPASİTESİ kg	ÖN GERME KUVVETİ kg	H2 TOPLAM YÜKSEKLİK mm	H1 YÜKLÜ TOPLAM YÜKSEKLİK mm	L YAY YOLU mm	YAYIN SON KUVVETİ kg
AY5107 D2OR 200 M	200	50	100	175x140	140x105	26x15	1000	40	275	235	40	300
AY5107 D2OR 200 K	200	50	100	175x140	140x105	26x15	1000	60	275	245	30	450
AY5107 D2OR 200 S	200	50	100	175x140	140x105	26x15	1000	70	275	250	25	600
AY5107 D2OR 250 M	250	60	120	175x140	140x105	26x15	1350	60	330	290	40	450
AY5107 D2OR 250 K	250	60	120	175x140	140x105	26x15	1350	100	330	300	30	750
AY5107 D2OR 250 S	250	60	120	175x140	140x105	26x15	1350	120	330	305	25	1000
AY5107 D2OR 260 M	260	65	120	175x140	140x105	26x15	1400	60	335	295	40	450
AY5107 D2OR 260 K	260	65	120	175x140	140x105	26x15	1400	100	335	305	30	750
AY5107 D2OR 260 S	260	65	120	175x140	140x105	26x15	1400	120	335	310	25	1000
AY5107 D2OR 300 M	300	70	120	175x140	140x105	26x15	1600	60	395	355	40	450
AY5107 D2OR 300 K	300	70	120	175x140	140x105	26x15	1600	100	395	365	30	750
AY5107 D2OR 300 S	300	70	120	175x140	140x105	26x15	1600	120	395	370	25	1000



KOR





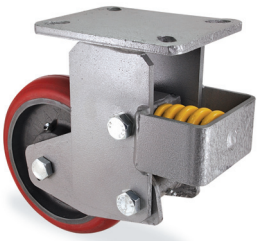

KAMALON KASNAK ÜZERİ DÖKME POLİÜRETAN KAPLAMA RULMANLI

KOD NO	 mm	 mm	 mm	 mm	 mm	 mm	MAKSİMUM TAŞIMA KAPASİTESİ kg	ÖN GERME KUVVETİ kg	H2 TOPLAM YÜKSEKLİK mm	H1 YÜKLÜ TOPLAM YÜKSEKLİK mm	L YAY YOLU mm	YAYIN SON KUVVETİ kg
AY5107 KOR 160 M	160	50	100	175x140	140x105	26x15	800	40	275	235	40	300
AY5107 KOR 160 K	160	50	100	175x140	140x105	26x15	800	60	275	245	30	450
AY5107 KOR 160 S	160	50	100	175x140	140x105	26x15	800	70	275	250	25	600
AY5107 KOR 200 M	200	50	100	175x140	140x105	26x15	1000	40	275	235	40	300
AY5107 KOR 200 K	200	50	100	175x140	140x105	26x15	1000	60	275	245	30	450
AY5107 KOR 200 S	200	50	100	175x140	140x105	26x15	1000	70	275	250	25	600
AY5107 KOR 250 M	250	50	120	175x140	140x105	26x15	1200	60	330	290	40	450
AY5107 KOR 250 K	250	50	120	175x140	140x105	26x15	1200	100	330	300	30	750
AY5107 KOR 250 S	250	50	120	175x140	140x105	26x15	1200	120	330	305	25	1000



K2OR







KAMALON KASNAK ÜZERİ OVAL DÖKME POLİÜRETAN KAPLAMA RULMANLI

KOD NO	 mm	 mm	 mm	 mm	 mm	 mm	MAKSİMUM TAŞIMA KAPASİTESİ kg	ÖN GERME KUVVETİ kg	H2 TOPLAM YÜKSEKLİK mm	H1 YÜKLÜ TOPLAM YÜKSEKLİK mm	L YAY YOLU mm	YAYIN SON KUVVETİ kg
AY5107 K2OR 160 M	160	50	100	175x140	140x105	26x15	800	40	275	235	40	300
AY5107 K2OR 160 K	160	50	100	175x140	140x105	26x15	800	60	275	245	30	450
AY5107 K2OR 160 S	160	50	100	175x140	140x105	26x15	800	70	275	250	25	600
AY5107 K2OR 200 M	200	50	100	175x140	140x105	26x15	1000	40	275	235	40	300
AY5107 K2OR 200 K	200	50	100	175x140	140x105	26x15	1000	60	275	245	30	450
AY5107 K2OR 200 S	200	50	100	175x140	140x105	26x15	1000	70	275	250	25	600
AY5107 K2OR 250 M	250	50	120	175x140	140x105	26x15	1200	60	330	290	40	450
AY5107 K2OR 250 K	250	50	120	175x140	140x105	26x15	1200	100	330	300	30	750
AY5107 K2OR 250 S	250	50	120	175x140	140x105	26x15	1200	120	330	305	25	1000



DZR





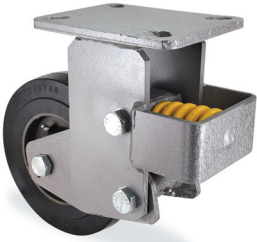

DÖKÜM KASNAK ÜZERİ VULKANİZE LASTİK KAPLAMA RULMANLI

KOD NO	 mm	 mm	 mm	 mm	 mm	 mm	MAKSİMUM TAŞIMA KAPASİTESİ kg	ÖN GERME KUVVETİ kg	H2 TOPLAM YÜKSEKLİK mm	H1 YÜKLÜ TOPLAM YÜKSEKLİK mm	L YAY YOLU mm	YAYIN SON KUVVETİ kg
AY5107 DZR 200 M	200	50	100	175x140	140x105	26x15	350	40	275	235	40	300
AY5107 DZR 200 K	200	50	100	175x140	140x105	26x15	350	60	275	245	30	450
AY5107 DZR 200 S	200	50	100	175x140	140x105	26x15	350	70	275	250	25	600
AY5107 DZR 250 M	250	60	120	175x140	140x105	26x15	500	60	330	290	40	450
AY5107 DZR 250 K	250	60	120	175x140	140x105	26x15	500	100	330	300	30	750
AY5107 DZR 250 S	250	60	120	175x140	140x105	26x15	500	120	330	305	25	1000
AY5107 DZR 300 M	300	70	120	175x140	140x105	26x15	600	60	395	355	40	450
AY5107 DZR 300 K	300	70	120	175x140	140x105	26x15	600	100	395	365	30	750
AY5107 DZR 300 S	300	70	120	175x140	140x105	26x15	600	120	395	370	25	1000



KYR





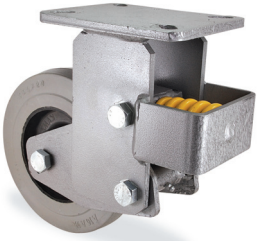

KAMALON KASNAK ÜZERİ VULKANİZE SİYAH LASTİK KAPLAMA RULMANLI

KOD NO	 mm	 mm	 mm	 mm	 mm	 mm	MAKSİMUM TAŞIMA KAPASİTESİ kg	ÖN GERME KUVVETİ kg	H2 TOPLAM YÜKSEKLİK mm	H1 YÜKLÜ TOPLAM YÜKSEKLİK mm	L YAY YOLU mm	YAYIN SON KUVVETİ kg
AY5107 KYR 160 M	160	50	100	175x140	140x105	26x15	240	40	275	235	40	300
AY5107 KYR 160 K	160	50	100	175x140	140x105	26x15	240	60	275	245	30	450
AY5107 KYR 160 S	160	50	100	175x140	140x105	26x15	240	70	275	250	25	600
AY5107 KYR 200 M	200	50	100	175x140	140x105	26x15	350	40	275	235	40	300
AY5107 KYR 200 K	200	50	100	175x140	140x105	26x15	350	60	275	245	30	450
AY5107 KYR 200 S	200	50	100	175x140	140x105	26x15	350	70	275	250	25	600
AY5107 KYR 250 M	250	50	120	175x140	140x105	26x15	500	60	330	290	40	450
AY5107 KYR 250 K	250	50	120	175x140	140x105	26x15	500	100	330	300	30	750
AY5107 KYR 250 S	250	50	120	175x140	140x105	26x15	500	120	330	305	25	1000



KER

KAMALON KASNAK ÜZERİ VULKANİZE GRİ LASTİK KAPLAMA RULMANLI





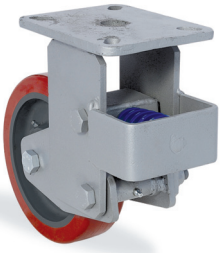

KOD NO	 mm	 mm	 mm	 mm	 mm	 mm	MAKSİMUM TAŞIMA KAPASİTESİ kg	ÖN GERME KUVVETİ kg	H2 TOPLAM YÜKSEKLİK mm	H1 YÜKLÜ TOPLAM YÜKSEKLİK mm	L YAY YOLU mm	YAYIN SON KUVVETİ kg
AY5107 KER 160 M	160	50	100	175x140	140x105	26x15	240	40	275	235	40	300
AY5107 KER 160 K	160	50	100	175x140	140x105	26x15	240	60	275	245	30	450
AY5107 KER 160 S	160	50	100	175x140	140x105	26x15	240	70	275	250	25	600
AY5107 KER 200 M	200	50	100	175x140	140x105	26x15	350	40	275	235	40	300
AY5107 KER 200 K	200	50	100	175x140	140x105	26x15	350	60	275	245	30	450
AY5107 KER 200 S	200	50	100	175x140	140x105	26x15	350	70	275	250	25	600
AY5107 KER 250 M	250	50	120	175x140	140x105	26x15	500	60	330	290	40	450
AY5107 KER 250 K	250	50	120	175x140	140x105	26x15	500	100	330	300	30	750
AY5107 KER 250 S	250	50	120	175x140	140x105	26x15	500	120	330	305	25	1000

AY5107 Serisi (Amortisörlü)



KUR





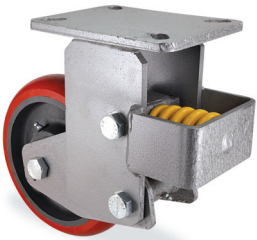

KAMALON KASNAK ÜZERİ ENJEKSİYON POLİÜRETAN KAPLAMA RULMANLI

KOD NO	 mm	 mm	 mm	 mm	 mm	 mm	MAKSİMUM TAŞIMA KAPASİTESİ kg	ÖN GERME KUVVETİ kg	H2 TOPLAM YÜKSEKLİK mm	H1 YÜKLÜ TOPLAM YÜKSEKLİK mm	L YAY YOLU mm	YAYIN SON KUVVETİ kg
AY5107 KUR 160 M	160	50	100	175x140	140x105	26x15	650	40	275	235	40	300
AY5107 KUR 160 K	160	50	100	175x140	140x105	26x15	650	60	275	245	30	450
AY5107 KUR 160 S	160	50	100	175x140	140x105	26x15	650	70	275	250	25	600
AY5107 KUR 200 M	200	50	100	175x140	140x105	26x15	800	40	275	235	40	300
AY5107 KUR 200 K	200	50	100	175x140	140x105	26x15	800	60	275	245	30	450
AY5107 KUR 200 S	200	50	100	175x140	140x105	26x15	800	70	275	250	25	600



K2UR





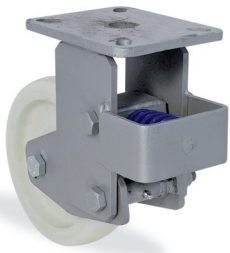

KAMALON KASNAK ÜZERİ OVAL ENJEKSİYON POLİÜRETAN KAPLAMA RULMANLI

KOD NO	 mm	 mm	 mm	 mm	 mm	 mm	MAKSİMUM TAŞIMA KAPASİTESİ kg	ÖN GERME KUVVETİ kg	H2 TOPLAM YÜKSEKLİK mm	H1 YÜKLÜ TOPLAM YÜKSEKLİK mm	L YAY YOLU mm	YAYIN SON KUVVETİ kg
AY5107 K2UR 160 M	160	50	100	175x140	140x105	26x15	650	40	275	235	40	300
AY5107 K2UR 160 K	160	50	100	175x140	140x105	26x15	650	60	275	245	30	450
AY5107 K2UR 160 S	160	50	100	175x140	140x105	26x15	650	70	275	250	25	600
AY5107 K2UR 200 M	200	50	100	175x140	140x105	26x15	800	40	275	235	40	300
AY5107 K2UR 200 K	200	50	100	175x140	140x105	26x15	800	60	275	245	30	450
AY5107 K2UR 200 S	200	50	100	175x140	140x105	26x15	800	70	275	250	25	600



RPR

AĞIR TİP POLİAMİD TEKER RULMANLI

KOD NO	 mm	 mm	 mm	 mm	 mm	 mm	MAKSİMUM TAŞIMA KAPASİTESİ kg	ÖN GERME KUVVETİ kg	H2 TOPLAM YÜKSEKLİK mm	H1 YÜKLÜ TOPLAM YÜKSEKLİK mm	L YAY YOLU mm	YAYIN SON KUVVETİ kg
AY5107 RPR 200 M	200	50	100	175x140	140x105	26x15	900	40	275	235	40	300
AY5107 RPR 200 K	200	50	100	175x140	140x105	26x15	900	60	275	245	30	450
AY5107 RPR 200 S	200	50	100	175x140	140x105	26x15	900	70	275	250	25	600
AY5107 RPR 250 M	250	60	120	175x140	140x105	26x15	1100	60	330	290	40	450
AY5107 RPR 250 K	250	60	120	175x140	140x105	26x15	1100	100	330	300	30	750
AY5107 RPR 250 S	250	60	120	175x140	140x105	26x15	1100	120	330	305	25	1000
AY5107 RPR 300 M	300	70	120	175x140	140x105	26x15	1400	60	395	355	40	450
AY5107 RPR 300 K	300	70	120	175x140	140x105	26x15	1400	100	395	365	30	750
AY5107 RPR 300 S	300	70	120	175x140	140x105	26x15	1400	120	395	370	25	1000

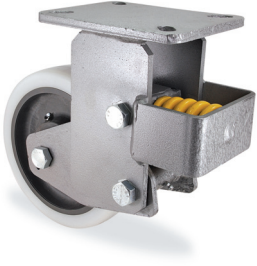



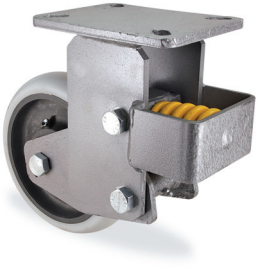





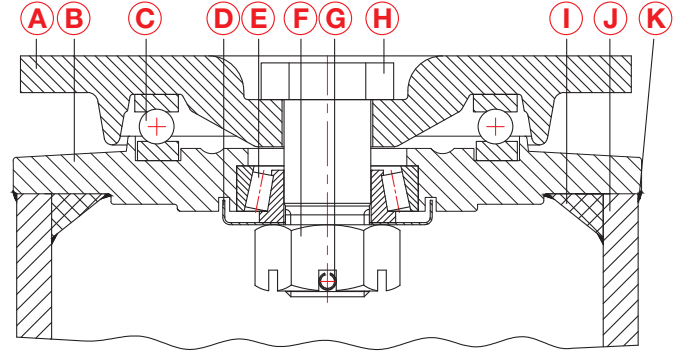

KPR		KAMALON KASNAK ÜZERİ POLİAMİD KAPLAMA RULMANLI										
KOD NO							MAKSİMUM TAŞIMA KAPASİTESİ kg	ÖN GERME KUVVETİ kg	H2 TOPLAM YÜKSEKLİK mm	H1 YÜKLÜ TOPLAM YÜKSEKLİK mm	L YAY YOLU mm	YAYIN SON KUVVETİ kg
AY5107 KPR 160 M	160	50	100	175x140	140x105	26x15	800	40	275	235	40	300
AY5107 KPR 160 K	160	50	100	175x140	140x105	26x15	800	60	275	245	30	450
AY5107 KPR 160 S	160	50	100	175x140	140x105	26x15	800	70	275	250	25	600
AY5107 KPR 200 M	200	50	100	175x140	140x105	26x15	1000	40	275	235	40	300
AY5107 KPR 200 K	200	50	100	175x140	140x105	26x15	1000	60	275	245	30	450
AY5107 KPR 200 S	200	50	100	175x140	140x105	26x15	1000	70	275	250	25	600





K2PR		KAMALON KASNAK ÜZERİ OVAL POLİAMİD KAPLAMA RULMANLI										
KOD NO							MAKSİMUM TAŞIMA KAPASİTESİ kg	ÖN GERME KUVVETİ kg	H2 TOPLAM YÜKSEKLİK mm	H1 YÜKLÜ TOPLAM YÜKSEKLİK mm	L YAY YOLU mm	YAYIN SON KUVVETİ kg
AY5107 K2PR 160 M	160	50	100	175x140	140x105	26x15	800	40	275	235	40	300
AY5107 K2PR 160 K	160	50	100	175x140	140x105	26x15	800	60	275	245	30	450
AY5107 K2PR 160 S	160	50	100	175x140	140x105	26x15	800	70	275	250	25	600
AY5107 K2PR 200 M	200	50	100	175x140	140x105	26x15	1000	40	275	235	40	300
AY5107 K2PR 200 K	200	50	100	175x140	140x105	26x15	1000	60	275	245	30	450
AY5107 K2PR 200 S	200	50	100	175x140	140x105	26x15	1000	70	275	250	25	600

- A:** DÖVME OYNAK TABLA
- B:** DÖVME ALT ÇANAK
- C:** BÜTE RULMAN
- D:** SAC METAL TOZLUK
- E:** KONİK RULMAN
- F:** AYARLANABİLİR TAÇLI SOMUN
- G:** YARIKLI PİM
- H:** TABLA BAĞLANTI CİVATASI
- I:** MAŞA AYAĞI DESTEK FEDERİ
- J:** OYNAK MAŞA AYAĞI
- K:** MAŞA AYAK KAYNAĞI











DDR		DÖKÜM TEKER RULMANLI							
KOD NO	 mm	 mm	 mm	 mm	 mm	 mm	 mm	 mm	 kg
5702 DDR 150	150	2x45	100	220	44	170x140	140x105	26x15	1600
5702 DDR 200	200	2x50	116	265	52	170x140	140x105	26x15	2200







DOR		DÖKÜM KASNAK ÜZERİ DÖKME POLİÜRETAN KAPLAMA RULMANLI							
KOD NO	 mm	 mm	 mm	 mm	 mm	 mm	 mm	 mm	 kg
5702 DOR 150	150	2x45	100	220	44	170x140	140x105	26x15	1400
5702 DOR 200	200	2x50	116	265	52	170x140	140x105	26x15	2000



D2OR		DÖKÜM KASNAK ÜZERİ OVAL DÖKME POLİÜRETAN KAPLAMA RULMANLI							
KOD NO	 mm	 mm	 mm	 mm	 mm	 mm	 mm	 mm	 kg
5702 D2OR 150	150	2x45	100	220	44	170x140	140x105	26x15	1400
5702 D2OR 200	200	2x50	116	265	52	170x140	140x105	26x15	2000



KOR		KAMALON KASNAK ÜZERİ DÖKME POLİÜRETAN KAPLAMA RULMANLI							
KOD NO									
	mm	mm	mm	mm	mm	mm	mm	mm	kg
5702 KOR 150	150	2x50	100	220	44	170x140	140x105	26x15	1400
5702 KOR 200	200	2x50	116	265	52	170x140	140x105	26x15	2000



K2OR		KAMALON KASNAK ÜZERİ OVAL DÖKME POLİÜRETAN KAPLAMA RULMANLI							
KOD NO									
	mm	mm	mm	mm	mm	mm	mm	mm	kg
5702 K2OR 150	150	2x50	100	220	44	170x140	140x105	26x15	1400
5702 K2OR 200	200	2x50	116	265	52	170x140	140x105	26x15	2000



DYR		DÖKÜM KASNAK ÜZERİ VULKANİZE LASTİK KAPLAMA RULMANLI							
KOD NO									
	mm	mm	mm	mm	mm	mm	mm	mm	kg
5702 DYR 150	150	2x45	100	220	44	170x140	140x105	26x15	400
5702 DYR 200	200	2x50	116	265	52	170x140	140x105	26x15	700



KYR		KAMALON KASNAK ÜZERİ VULKANİZE SİYAH LASTİK KAPLAMA RULMANLI							
KOD NO									
	mm	mm	mm	mm	mm	mm	mm	mm	kg
5702 KYR 150	150	2x45	100	220	44	170x140	140x105	26x15	400
5702 KYR 200	200	2x50	116	265	52	170x140	140x105	26x15	700



KER		KAMALON KASNAK ÜZERİ VULKANİZE GRİ LASTİK KAPLAMA RULMANLI							
KOD NO									kg
5702 KER 150	150	2x45	100	220	44	170x140	140x105	26x15	400
5702 KER 200	200	2x50	116	265	52	170x140	140x105	26x15	700











KUR		KAMALON KASNAK ÜZERİ ENJEKSİYON POLİÜRETAN KAPLAMA RULMANLI							
KOD NO									kg
5702 KUR 150	150	2x50	100	220	44	170x140	140x105	26x15	1100
5702 KUR 200	200	2x50	116	265	52	170x140	140x105	26x15	1600



K2UR		KAMALON KASNAK ÜZERİ OVAL ENJEKSİYON POLİÜRETAN KAPLAMA RULMANLI							
KOD NO									kg
5702 K2UR 150	150	2x50	100	220	44	170x140	140x105	26x15	1100
5702 K2UR 200	200	2x50	116	265	52	170x140	140x105	26x15	1600





RPR		AĞIR TİP POLİAMİD TEKER RULMANLI							
KOD NO									kg
5702 RPR 150	150	2x45	100	220	44	170x140	140x105	26x15	1200
5702 RPR 200	200	2x50	116	265	52	170x140	140x105	26x15	1800



KPR		KAMALON KASNAK ÜZERİ POLİAMİD KAPLAMA RULMANLI							
KOD NO									
	mm	mm	mm	mm	mm	mm	mm	mm	kg
5702 KPR 150	150	2x50	100	220	44	170x140	140x105	26x15	1400
5702 KPR 200	200	2x50	116	265	52	170x140	140x105	26x15	2000





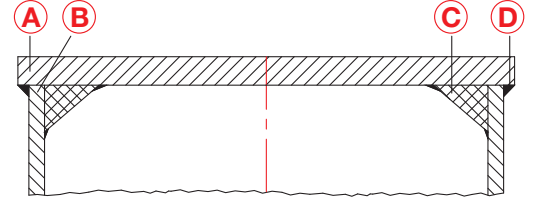

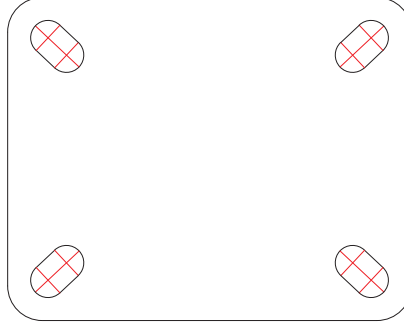

K2PR		KAMALON KASNAK ÜZERİ OVAL POLİAMİD KAPLAMA RULMANLI							
KOD NO									
	mm	mm	mm	mm	mm	mm	mm	mm	kg
5702 K2PR 150	150	2x50	100	220	44	170x140	140x105	26x15	1400
5702 K2PR 200	200	2x50	116	265	52	170x140	140x105	26x15	2000



- A:** DÖVME SABİT TABLA
B: SABİT MAŞA AYAĞI
C: MAŞA AYAĞI DESTEK FEDERİ
D: MAŞA AYAK KAYNAĞI









DDR		DÖKÜM TEKER RULMANLI						
KOD NO	 mm	 mm	 mm	 mm	 mm	 mm	 mm	kg
5707 DDR 150	150	2x45	100	220	170x140	140x145	26x15	1600
5707 DDR 200	200	2x50	116	265	170x140	140x145	26x15	2200



DOR		DÖKÜM KASNAK ÜZERİ DÖKME POLİÜRETAN KAPLAMA RULMANLI						
KOD NO	 mm	 mm	 mm	 mm	 mm	 mm	 mm	kg
5707 DOR 150	150	2x45	100	220	170x140	140x145	26x15	1400
5707 DOR 200	200	2x50	116	265	170x140	140x145	26x15	2000



D2OR		DÖKÜM KASNAK ÜZERİ OVAL DÖKME POLİÜRETAN KAPLAMA RULMANLI						
KOD NO	 mm	 mm	 mm	 mm	 mm	 mm	 mm	kg
5707 D2OR 150	150	2x45	100	220	170x140	140x145	26x15	1400
5707 D2OR 200	200	2x50	116	265	170x140	140x145	26x15	2000



KOR		KAMALON KASNAK ÜZERİ DÖKME POLİÜRETAN KAPLAMA RULMANLI							
KOD NO	 mm	 mm	 mm	 mm	 mm	 mm	 mm	 kg	
5707 KOR 150	150	2x50	100	220	170x140	140x105	26x15	1400	
5707 KOR 200	200	2x50	116	265	170x140	140x105	26x15	2000	



K2OR		KAMALON KASNAK ÜZERİ OVAL DÖKME POLİÜRETAN KAPLAMA RULMANLI							
KOD NO	 mm	 mm	 mm	 mm	 mm	 mm	 mm	 kg	
5707 K2OR 150	150	2x50	100	220	170x140	140x105	26x15	1400	
5707 K2OR 200	200	2x50	116	265	170x140	140x105	26x15	2000	



DYR		DÖKÜM KASNAK ÜZERİ VULKANİZE LASTİK KAPLAMA RULMANLI							
KOD NO	 mm	 mm	 mm	 mm	 mm	 mm	 mm	 kg	
5707 DYR 150	150	2x45	100	220	170x140	140x105	26x15	400	
5707 DYR 200	200	2x50	116	265	170x140	140x105	26x15	700	



KYR		KAMALON KASNAK ÜZERİ VULKANİZE SİYAH LASTİK KAPLAMA RULMANLI							
KOD NO	 mm	 mm	 mm	 mm	 mm	 mm	 mm	 kg	
5707 KYR 150	150	2x45	100	220	170x140	140x105	26x15	400	
5707 KYR 200	200	2x50	116	265	170x140	140x105	26x15	700	



KER		KAMALON KASNAK ÜZERİ VULKANİZE GRİ LASTİK KAPLAMA RULMANLI						
KOD NO	 mm	 mm	 mm	 mm	 mm	 mm	 mm	 kg
5707 KER 150	150	2x45	100	220	170x140	140x105	26x15	400
5707 KER 200	200	2x50	116	265	170x140	140x105	26x15	700

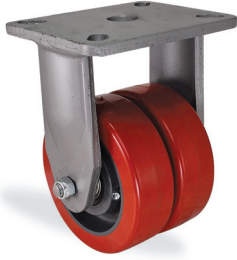









KUR		KAMALON KASNAK ÜZERİ ENJEKSİYON POLİÜRETAN KAPLAMA RULMANLI						
KOD NO	 mm	 mm	 mm	 mm	 mm	 mm	 mm	 kg
5707 KUR 150	150	2x50	100	220	170x140	140x105	26x15	1100
5707 KUR 200	200	2x50	116	265	170x140	140x105	26x15	1600



K2UR		KAMALON KASNAK ÜZERİ OVAL ENJEKSİYON POLİÜRETAN KAPLAMA RULMANLI						
KOD NO	 mm	 mm	 mm	 mm	 mm	 mm	 mm	 kg
5707 K2UR 150	150	2x50	100	220	170x140	140x105	26x15	1100
5707 K2UR 200	200	2x50	116	265	170x140	140x105	26x15	1600











RPR		AĞIR TİP POLİAMİD TEKER RULMANLI						
KOD NO	 mm	 mm	 mm	 mm	 mm	 mm	 mm	 kg
5707 RPR 150	150	2x45	100	220	170x140	140x105	26x15	1200
5707 RPR 200	200	2x50	116	265	170x140	140x105	26x15	1800



KPR		KAMALON KASNAK ÜZERİ POLİAMİD KAPLAMA RULMANLI						
KOD NO	 mm	 mm	 mm	 mm	 mm	 mm	 mm	 kg
5707 KPR 150	150	2x50	100	220	170x140	140x105	26x15	1400
5707 KPR 200	200	2x50	116	265	170x140	140x105	26x15	2000



K2PR		KAMALON KASNAK ÜZERİ OVAL POLİAMİD KAPLAMA RULMANLI						
KOD NO	 mm	 mm	 mm	 mm	 mm	 mm	 mm	 kg
5707 K2PR 150	150	2x50	100	220	170x140	140x105	26x15	1400
5707 K2PR 200	200	2x50	116	265	170x140	140x105	26x15	2000

- A:** DÖVME ÇELİĞİ OYNAK TABLA
- B:** BÜTE RULMAN
- C:** TABLA BAĞLANTI CİVATASI
- D:** KONİK RULMAN
- E:** DÖVME ÇELİĞİ MAŞA ÇANAĞI
- F:** GRESÖRLÜK
- G:** METAL MUHAFAZA TOZLUK
- H:** AYARLANABİLİR TAÇLI SOMUN
- I:** YARIKLI PİM
- J:** MAŞA AYAK KAYNAĞI
- K:** OYNAK MAŞA AYAĞI
- L:** OYNAK MAŞA ORTA AYAĞI

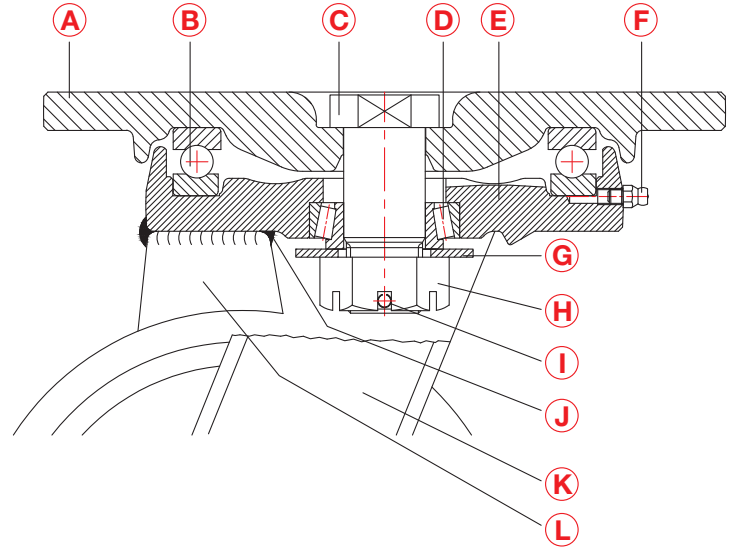

DDR		DÖKÜM TEKER RULMANLI								
KOD NO										
	mm	mm	mm	mm	mm	mm	mm	mm	kg	
6702 DDR 150	150	2x45	142	235	44	250x200	210x160	17	1600	
6702 DDR 200	200	2x50	142	280	52	250x200	210x160	17	2000	
6702 DDR 250	250	2x50	166	334	64	250x200	210x160	17	2400	

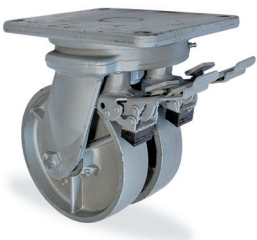

DDR		DÖKÜM TEKER RULMANLI								
KOD NO										
	mm	mm	mm	mm	mm	mm	mm	mm	mm	kg
6702 DDR 150 F09	150	2x45	142	235	44	175	250x200	210x160	17	1600
6702 DDR 200 F09	200	2x50	142	280	52	175	250x200	210x160	17	2000
6702 DDR 250 F09	250	2x50	166	334	64	175	250x200	210x160	17	2400











DOR		DÖKÜM KASNAK ÜZERİ DÖKME POLİÜRETAN KAPLAMA RULMANLI								
KOD NO										
	mm	mm	mm	mm	mm	mm	mm	mm	kg	
6702 DOR 150	150	2x45	142	235	44	250x200	210x160	17	1400	
6702 DOR 200	200	2x50	142	280	52	250x200	210x160	17	2000	
6702 DOR 250	250	2x60	166	334	64	250x200	210x160	17	2700	
6702 DOR 260	260	2x65	166	339	64	250x200	210x160	17	2800	
6702 DOR 300	300	2x70	182	377	71	250x200	210x160	17	3200	
6702 DOR 350	350	2x80	182	426	81	250x200	210x160	17	3600	









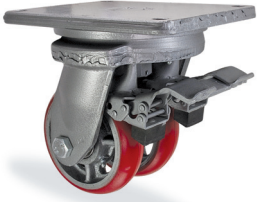



DOR		DÖKÜM KASNAK ÜZERİ DÖKME POLİÜRETAN KAPLAMA RULMANLI								
KOD NO										
	mm	mm	mm	mm	mm	mm	mm	mm	kg	
6702 DOR 150 F09	150	2x45	142	235	44	175	250x200	210x160	17	1400
6702 DOR 200 F09	200	2x50	142	280	52	175	250x200	210x160	17	2000
6702 DOR 250 F09	250	2x60	166	334	64	175	250x200	210x160	17	2700
6702 DOR 260 F09	260	2x65	166	339	64	175	250x200	210x160	17	2800
6702 DOR 300 F09	300	2x70	182	377	71	175	250x200	210x160	17	3200
6702 DOR 350 F09	350	2x80	182	426	81	175	250x200	210x160	17	3600













D2OR		DÖKÜM KASNAK ÜZERİ OVAL DÖKME POLİÜRETAN KAPLAMA RULMANLI								
KOD NO										
	mm	mm	mm	mm	mm	mm	mm	mm	kg	
6702 D2OR 150	150	2x45	142	235	44	250x200	210x160	17	1400	
6702 D2OR 200	200	2x50	142	280	52	250x200	210x160	17	2000	
6702 D2OR 250	250	2x60	166	334	64	250x200	210x160	17	2700	
6702 D2OR 260	260	2x65	166	339	64	250x200	210x160	17	2800	
6702 D2OR 300	300	2x70	182	377	71	250x200	210x160	17	3200	











D2OR
DÖKÜM KASNAK ÜZERİ OVAL DÖKME POLİÜRETAN KAPLAMA RULMANLI

KOD NO	 mm	 mm	 mm	 mm	 mm	 mm	 mm	 mm	 mm	 kg
6702 D2OR 150 F09	150	2x45	142	235	44	175	250x200	210x160	17	1400
6702 D2OR 200 F09	200	2x50	142	280	52	175	250x200	210x160	17	2000
6702 D2OR 250 F09	250	2x60	166	334	64	175	250x200	210x160	17	2700
6702 D2OR 260 F09	260	2x65	166	339	64	175	250x200	210x160	17	2800
6702 D2OR 300 F09	300	2x70	182	377	71	175	250x200	210x160	17	3200











KOR
KAMALON KASNAK ÜZERİ DÖKME POLİÜRETAN KAPLAMA RULMANLI

KOD NO	 mm	 mm	 mm	 mm	 mm	 mm	 mm	 mm	 mm	 kg
6702 KOR 150	150	2x50	142	235	44	175	250x200	210x160	17	1400
6702 KOR 200	200	2x50	142	280	52	175	250x200	210x160	17	2000
6702 KOR 250	250	2x50	166	334	64	175	250x200	210x160	17	2400











KOR
KAMALON KASNAK ÜZERİ DÖKME POLİÜRETAN KAPLAMA RULMANLI

KOD NO	 mm	 mm	 mm	 mm	 mm	 mm	 mm	 mm	 mm	 kg
6702 KOR 150 F09	150	2x50	142	235	44	175	250x200	210x160	17	1400
6702 KOR 200 F09	200	2x50	142	280	52	175	250x200	210x160	17	2000
6702 KOR 250 F09	250	2x50	166	334	64	175	250x200	210x160	17	2400











K2OR
KAMALON KASNAK ÜZERİ OVAL DÖKME POLİÜRETAN KAPLAMA RULMANLI

KOD NO	 mm	 mm	 mm	 mm	 mm	 mm	 mm	 mm	 mm	 kg
6702 K2OR 150	150	2x50	142	235	44	175	250x200	210x160	17	1400
6702 K2OR 200	200	2x50	142	280	52	175	250x200	210x160	17	2000
6702 K2OR 250	250	2x50	166	334	64	175	250x200	210x160	17	2400











K2OR
KAMALON KASNAK ÜZERİ OVAL DÖKME POLİÜRETAN KAPLAMA RULMANLI

KOD NO	 mm	 mm	 mm	 mm	 mm	 mm	 mm	 mm	 mm	 kg
6702 K2OR 150 F09	150	2x50	142	235	44	175	250x200	210x160	17	1400
6702 K2OR 200 F09	200	2x50	142	280	52	175	250x200	210x160	17	2000
6702 K2OR 250 F09	250	2x50	166	334	64	175	250x200	210x160	17	2400

DYZ
DÖKÜM KASNAK ÜZERİ VULKANİZE LASTİK KAPLAMA RULMANLI

KOD NO	 mm	 mm	 mm	 mm	 mm	 mm	 mm	 mm	 mm	 kg
6702 DYZ 150	150	2x45	142	235	44	175	250x200	210x160	17	400
6702 DYZ 200	200	2x50	142	280	52	175	250x200	210x160	17	700
6702 DYZ 220	220	2x50	142	298	55	175	250x200	210x160	17	900
6702 DYZ 250	250	2x60	166	334	64	175	250x200	210x160	17	1000
6702 DYZ 300	300	2x70	182	377	71	175	250x200	210x160	17	1200
6702 DYZ 350	350	2x80	182	426	81	175	250x200	210x160	17	1300
6702 DYZ 380	380	2x80	182	452.5	86	175	250x200	210x160	17	1600

DYZ
DÖKÜM KASNAK ÜZERİ VULKANİZE LASTİK KAPLAMA RULMANLI

KOD NO	 mm	 mm	 mm	 mm	 mm	 mm	 mm	 mm	 mm	 kg
6702 DYZ 150 F09	150	2x45	142	235	44	175	250x200	210x160	17	400
6702 DYZ 200 F09	200	2x50	142	280	52	175	250x200	210x160	17	700
6702 DYZ 220 F09	220	2x50	142	298	55	175	250x200	210x160	17	900
6702 DYZ 250 F09	250	2x60	166	334	64	175	250x200	210x160	17	1000
6702 DYZ 300 F09	300	2x70	182	377	71	175	250x200	210x160	17	1200
6702 DYZ 350 F09	350	2x80	182	426	81	175	250x200	210x160	17	1300
6702 DYZ 380 F09	380	2x80	182	452.5	86	175	250x200	210x160	17	1600



KYR		KAMALON KASNAK ÜZERİ VULKANİZE SİYAH LASTİK KAPLAMA RULMANLI								
KOD NO										
	mm	mm	mm	mm	mm	mm	mm	mm	kg	
6702 KYR 150	150	2x45	142	235	44	250x200	210x160	17	400	
6702 KYR 200	200	2x50	142	280	52	250x200	210x160	17	700	
6702 KYR 250	250	2x50	166	334	64	250x200	210x160	17	1000	



KYR		KAMALON KASNAK ÜZERİ VULKANİZE SİYAH LASTİK KAPLAMA RULMANLI								
KOD NO										
	mm	mm	mm	mm	mm	mm	mm	mm	kg	
6702 KYR 150 F09	150	2x45	142	235	44	175	250x200	210x160	17	400
6702 KYR 200 F09	200	2x50	142	280	52	175	250x200	210x160	17	700
6702 KYR 250 F09	250	2x50	166	334	64	175	250x200	210x160	17	1000



KER		KAMALON KASNAK ÜZERİ VULKANİZE GRİ LASTİK KAPLAMA RULMANLI								
KOD NO										
	mm	mm	mm	mm	mm	mm	mm	mm	kg	
6702 KER 150	150	2x45	142	235	44	250x200	210x160	17	400	
6702 KER 200	200	2x50	142	280	52	250x200	210x160	17	700	
6702 KER 250	250	2x50	166	334	64	250x200	210x160	17	1000	

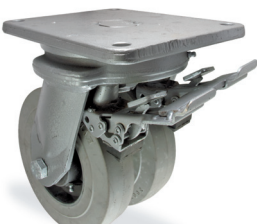

KER		KAMALON KASNAK ÜZERİ VULKANİZE GRİ LASTİK KAPLAMA RULMANLI								
KOD NO										
	mm	mm	mm	mm	mm	mm	mm	mm	kg	
6702 KER 150 F09	150	2x45	142	235	44	175	250x200	210x160	17	400
6702 KER 200 F09	200	2x50	142	280	52	175	250x200	210x160	17	700
6702 KER 250 F09	250	2x50	166	334	64	175	250x200	210x160	17	1000



KUR		KAMALON KASNAK ÜZERİ ENJEKSİYON POLİÜRETAN KAPLAMA RULMANLI								
KOD NO										
	mm	mm	mm	mm	mm	mm	mm	mm	mm	kg
6702 KUR 150	150	2x50	142	235	44	250x200	210x160	17		1100
6702 KUR 200	200	2x50	142	280	52	250x200	210x160	17		1600

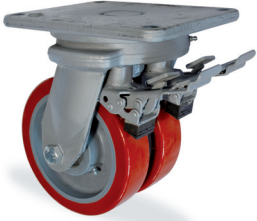

KUR		KAMALON KASNAK ÜZERİ ENJEKSİYON POLİÜRETAN KAPLAMA RULMANLI								
KOD NO										
	mm	mm	mm	mm	mm	mm	mm	mm	mm	kg
6702 KUR 150 F09	150	2x50	142	235	44	175	250x200	210x160	17	1100
6702 KUR 200 F09	200	2x50	142	280	52	175	250x200	210x160	17	1600













K2UR		KAMALON KASNAK ÜZERİ OVAL ENJEKSİYON POLİÜRETAN KAPLAMA RULMANLI								
KOD NO										
	mm	mm	mm	mm	mm	mm	mm	mm	mm	kg
6702 K2UR 150	150	2x50	142	235	44	250x200	210x160	17		1100
6702 K2UR 200	200	2x50	142	280	52	250x200	210x160	17		1600













K2UR		KAMALON KASNAK ÜZERİ OVAL ENJEKSİYON POLİÜRETAN KAPLAMA RULMANLI								
KOD NO										
	mm	mm	mm	mm	mm	mm	mm	mm	mm	kg
6702 K2UR 150 F09	150	2x50	142	235	44	175	250x200	210x160	17	1100
6702 K2UR 200 F09	200	2x50	142	280	52	175	250x200	210x160	17	1600



RPR		AĞIR TİP POLİAMİD TEKER RULMANLI								
KOD NO										
	mm	mm	mm	mm	mm	mm	mm	mm	mm	kg
6702 RPR 150	150	2x45	142	235	44	250x200	210x160	17		1200
6702 RPR 200	200	2x50	142	280	52	250x200	210x160	17		1800
6702 RPR 250	250	2x60	166	334	64	250x200	210x160	17		2200
6702 RPR 270	270	2x70	182	362	71	250x200	210x160	17		2800



RPR		AĞIR TİP POLİAMİD TEKER RULMANLI								
KOD NO										
	mm	mm	mm	mm	mm	mm	mm	mm	mm	kg
6702 RPR 150 F09	150	2x45	142	235	44	175	250x200	210x160	17	1200
6702 RPR 200 F09	200	2x50	142	280	52	175	250x200	210x160	17	1800
6702 RPR 250 F09	250	2x60	166	334	64	175	250x200	210x160	17	2200
6702 RPR 270 F09	270	2x70	182	362	71	175	250x200	210x160	17	2800



KPR		KAMALON KASNAK ÜZERİ POLİAMİD KAPLAMA RULMANLI								
KOD NO										
	mm	mm	mm	mm	mm	mm	mm	mm	mm	kg
6702 KPR 150	150	2x50	142	235	44		250x200	210x160	17	1400
6702 KPR 200	200	2x50	142	280	52		250x200	210x160	17	2000



KPR		KAMALON KASNAK ÜZERİ POLİAMİD KAPLAMA RULMANLI								
KOD NO										
	mm	mm	mm	mm	mm	mm	mm	mm	mm	kg
6702 KPR 150 F09	150	2x50	142	235	44	175	250x200	210x160	17	1400
6702 KPR 200 F09	200	2x50	142	280	52	175	250x200	210x160	17	2000



K2PR		KAMALON KASNAK ÜZERİ OVAL POLİAMİD KAPLAMA RULMANLI								
KOD NO										
	mm	mm	mm	mm	mm	mm	mm	mm	kg	
6702 K2PR 150	150	2x50	142	235	44	250x200	210x160	17	1400	
6702 K2PR 200	200	2x50	142	280	52	250x200	210x160	17	2000	





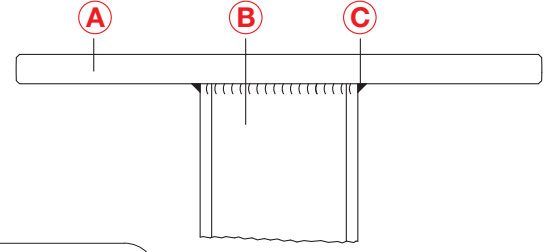





K2PR		KAMALON KASNAK ÜZERİ OVAL POLİAMİD KAPLAMA RULMANLI								
KOD NO										
	mm	mm	mm	mm	mm	mm	mm	mm	kg	
6702 K2PR 150 F09	150	2x50	142	235	44	175	250x200	210x160	17	1400
6702 K2PR 200 F09	200	2x50	142	280	52	175	250x200	210x160	17	2000











- A:** DÖVME ÇELİĞİ SABİT TABLA
B: SABİT MAŞA AYAĞI
C: MAŞA AYAK KAYNAĞI









**DDR****DÖKÜM TEKER RULMANLI**

KOD NO	 mm	 mm	 mm	 mm	 mm	 mm	 mm	 kg
6707 DDR 150	150	2x45	142	235	250x200	210x160	17	1600
6707 DDR 200	200	2x50	142	280	250x200	210x160	17	2000
6707 DDR 250	250	2x50	166	334	250x200	210x160	17	2400









**DOR****DÖKÜM KASNAK ÜZERİ DÖKME POLİÜRETAN KAPLAMA RULMANLI**

KOD NO	 mm	 mm	 mm	 mm	 mm	 mm	 mm	 kg
6707 DOR 150	150	2x45	142	235	250x200	210x160	17	1400
6707 DOR 200	200	2x50	142	280	250x200	210x160	17	2000
6707 DOR 250	250	2x60	142	334	250x200	210x160	17	2700
6707 DOR 260	260	2x65	166	339	250x200	210x160	17	2800
6707 DOR 300	300	2x70	182	377	250x200	210x160	17	3200
6707 DOR 350	350	2x80	182	426	250x200	210x160	17	3600









D2OR
DÖKÜM KASNAK ÜZERİ OVAL DÖKME POLİÜRETAN KAPLAMA RULMANLI

KOD NO	 mm	 mm	 mm	 mm	 mm	 mm	 mm	 kg
6707 D2OR 150	150	2x45	142	235	250x200	210x160	17	1400
6707 D2OR 200	200	2x50	142	280	250x200	210x160	17	2000
6707 D2OR 250	250	2x60	166	334	250x200	210x160	17	2700
6707 D2OR 260	260	2x65	166	339	250x200	210x160	17	2800
6707 D2OR 300	300	2x70	182	377	250x200	210x160	17	3200









KOR
KAMALON KASNAK ÜZERİ DÖKME POLİÜRETAN KAPLAMA RULMANLI

KOD NO	 mm	 mm	 mm	 mm	 mm	 mm	 mm	 kg
6707 KOR 150	150	2x50	142	235	250x200	210x160	17	1400
6707 KOR 200	200	2x50	142	280	250x200	210x160	17	2000
6707 KOR 250	250	2x50	166	334	250x200	210x160	17	2400

K2OR
KAMALON KASNAK ÜZERİ OVAL DÖKME POLİÜRETAN KAPLAMA RULMANLI

KOD NO	 mm	 mm	 mm	 mm	 mm	 mm	 mm	 kg
6707 K2OR 150	150	2x50	142	235	250x200	210x160	17	1400
6707 K2OR 200	200	2x50	142	280	250x200	210x160	17	2000
6707 K2OR 250	250	2x50	166	334	250x200	210x160	17	2400

DYR
DÖKÜM KASNAK ÜZERİ VULKANİZE LASTİK KAPLAMA RULMANLI

KOD NO	 mm	 mm	 mm	 mm	 mm	 mm	 mm	 kg
6707 DYR 150	150	2x45	142	235	250x200	210x160	17	400
6707 DYR 200	200	2x50	142	280	250x200	210x160	17	700
6707 DYR 220	220	2x60	142	298	250x200	210x160	17	900
6707 DYR 250	250	2x60	166	334	250x200	210x160	17	1000
6707 DYR 300	300	2x70	182	377	250x200	210x160	17	1200
6707 DYR 350	350	2x80	182	426	250x200	210x160	17	1300
6707 DYR 380	380	2x80	182	452.5	250x200	210x160	17	1600



KYR		KAMALON KASNAK ÜZERİ VULKANİZE SİYAH LASTİK KAPLAMA RULMANLI						
KOD NO	 mm	 mm	 mm	 mm	 mm	 mm	 mm	 kg
6707 KYR 150	150	2x45	142	235	250x200	210x160	17	400
6707 KYR 200	200	2x50	142	280	250x200	210x160	17	700
6707 KYR 250	250	2x50	166	334	250x200	210x160	17	1000



KER		KAMALON KASNAK ÜZERİ VULKANİZE GRİ LASTİK KAPLAMA RULMANLI						
KOD NO	 mm	 mm	 mm	 mm	 mm	 mm	 mm	 kg
6707 KER 150	150	2x45	142	235	250x200	210x160	17	400
6707 KER 200	200	2x50	142	280	250x200	210x160	17	700
6707 KER 250	250	2x50	166	334	250x200	210x160	17	1000











KUR		KAMALON KASNAK ÜZERİ ENJEKSİYON POLİÜRETAN KAPLAMA RULMANLI						
KOD NO	 mm	 mm	 mm	 mm	 mm	 mm	 mm	 kg
6707 KUR 150	150	2x50	142	235	250x200	210x160	17	1100
6707 KUR 200	200	2x50	142	280	250x200	210x160	17	1600







K2UR		KAMALON KASNAK ÜZERİ OVAL ENJEKSİYON POLİÜRETAN KAPLAMA RULMANLI						
KOD NO	 mm	 mm	 mm	 mm	 mm	 mm	 mm	 kg
6707 K2UR 150	150	2x50	142	235	250x200	210x160	17	1100
6707 K2UR 200	200	2x50	142	280	250x200	210x160	17	1600



RPR		AĞIR TİP POLİAMİD TEKER RULMANLI						
KOD NO	 mm	 mm	 mm	 mm	 mm	 mm	 mm	 kg
6707 RPR 150	150	2x45	142	235	250x200	210x160	17	1200
6707 RPR 200	200	2x50	142	280	250x200	210x160	17	1800
6707 RPR 250	250	2x60	166	334	250x200	210x160	17	2200
6707 RPR 270	270	2x70	182	362	250x200	210x160	17	2800



KPR		KAMALON KASNAK ÜZERİ POLİAMİD KAPLAMA RULMANLI						
KOD NO	 mm	 mm	 mm	 mm	 mm	 mm	 mm	 kg
6707 KPR 150	150	2x50	142	235	250x200	210x160	17	1400
6707 KPR 200	200	2x50	142	280	250x200	210x160	17	2000



K2PR		KAMALON KASNAK ÜZERİ OVAL POLİAMİD KAPLAMA RULMANLI						
KOD NO	 mm	 mm	 mm	 mm	 mm	 mm	 mm	 kg
6707 K2PR 150	150	2x50	142	235	250x200	210x160	17	1400
6707 K2PR 200	200	2x50	142	280	250x200	210x160	17	2000

AD6702 Serisi (Amortisörlü)

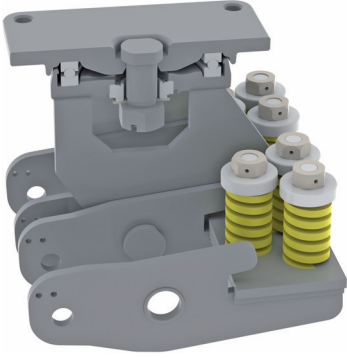

- A:** DÖVME OYNAK TABLA
- B:** BÜTE RULMAN
- C:** DÖVME ÜST BİLYA ÇANAĞI
- D:** TABLA CİVATASI
- E:** KONİK RULMAN
- F:** MAŞA AYAK KAYNAĞI
- G:** GRESÖRLÜK
- H:** MAŞA ORTA AYAK
- I:** MUHAFAZA SAC TOZLUK
- J:** AYARLANABİLİR TAÇLI SOMUN
- K:** YARIKLI PİM
- L:** MAŞA AYAĞI
- M:** HAREKETLİ MAŞA AYAĞI
- N:** YAY MONTAJ SOMUNU
- O:** YAY BASKI PULU
- P:** AMORTİSÖR YAYI
- R:** YAY BASKI PLAKASI

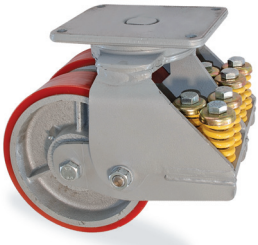
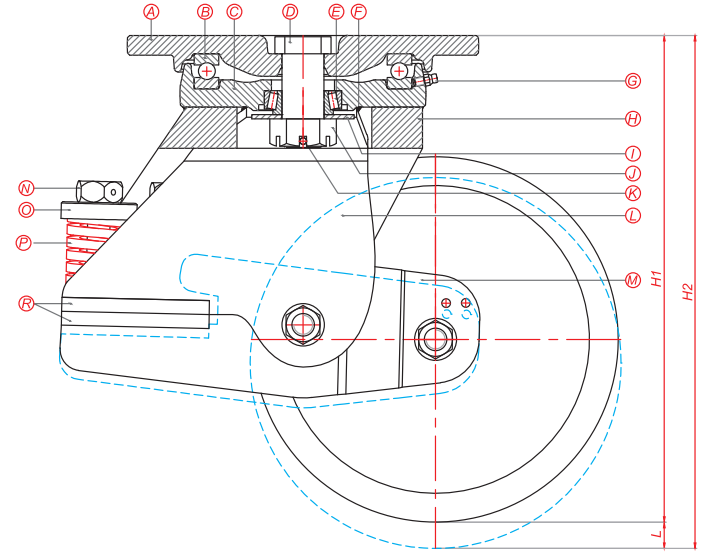

DOR		DÖKÜM KASNAK ÜZERİ DÖKME POLİÜRETAN KAPLAMA RULMANLI											
KOD NO	mm	mm	mm	mm	mm	mm	mm	MAKSİMUM TAŞIMA KAPASİTESİ kg	ÖN GERME KUVVETİ kg	H2 TOPLAM YÜKSEKLİK mm	H1 YÜKLÜ TOPLAM YÜKSEKLİK mm	L YAY YOLU mm	YAYIN SON KUVVETİ kg
AD6702 DOR 270	270	2x80	224	95	250x200	210x160	17	5000	1000	355	345	10	5000

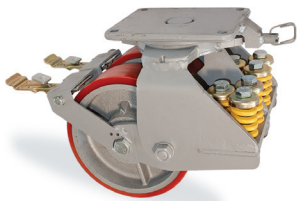







DOR		DÖKÜM KASNAK ÜZERİ DÖKME POLİÜRETAN KAPLAMA RULMANLI												
KOD NO	mm	mm	mm	mm	mm	mm	mm	MAKSİMUM TAŞIMA KAPASİTESİ kg	ÖN GERME KUVVETİ kg	H2 TOPLAM YÜKSEKLİK mm	H1 YÜKLÜ TOPLAM YÜKSEKLİK mm	L YAY YOLU mm	YAYIN SON KUVVETİ kg	
AD6702 DOR 270 F04	270	2x80	224	95	365	250x200	210x160	17	5000	1000	355	345	10	5000







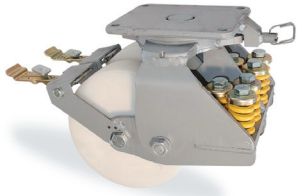

• F20 yön kilit fren sistemi opsiyoneldir.



RPR		AĞIR TİP POLİAMİD TEKER RULMANLI											
KOD NO	 mm	 mm	 mm	 mm	 mm	 mm	 mm	MAKSİMUM TAŞIMA KAPASİTESİ kg	ÖN GERME KUVVETİ kg	H2 TOPLAM YÜKSEKLİK mm	H1 YÜKLÜ TOPLAM YÜKSEKLİK mm	L YAY YOLU mm	YAYIN SON KUVVETİ kg
AD6702 RPR 270	270	2x70	224	95	250x200	210x160	17	2500	1000	355	345	10	5000



RPR		AĞIR TİP POLİAMİD TEKER RULMANLI												
KOD NO	 mm	 mm	 mm	 mm	 mm	 mm	 mm	MAKSİMUM TAŞIMA KAPASİTESİ kg	ÖN GERME KUVVETİ kg	H2 TOPLAM YÜKSEKLİK mm	H1 YÜKLÜ TOPLAM YÜKSEKLİK mm	L YAY YOLU mm	YAYIN SON KUVVETİ kg	
AD6702 RPR 270 F04	270	2x70	224	95	365	250x200	210x160	17	2500	1000	355	345	10	5000



• F20 yön kilit fren sistemi opsiyoneldir.

AD6707 Serisi (Amortisörlü)

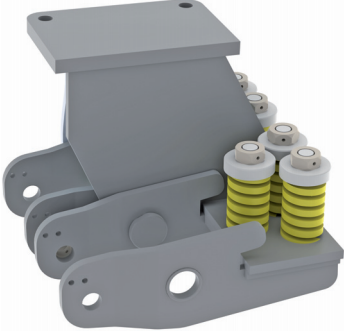

- A:** DÖVME SABİT TABLA
- B:** MAŞA AYAK KAYNAĞI
- C:** MAŞA ORTA AYAK
- D:** MAŞA AYAĞI
- E:** HAREKETLİ MAŞA AYAĞI
- F:** YAY MONTAJ SOMUNU
- G:** YAY BASKI PULU
- H:** AMORTİSÖR YAYI
- I:** YAY BASKI PLAKASI

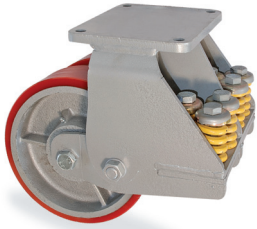
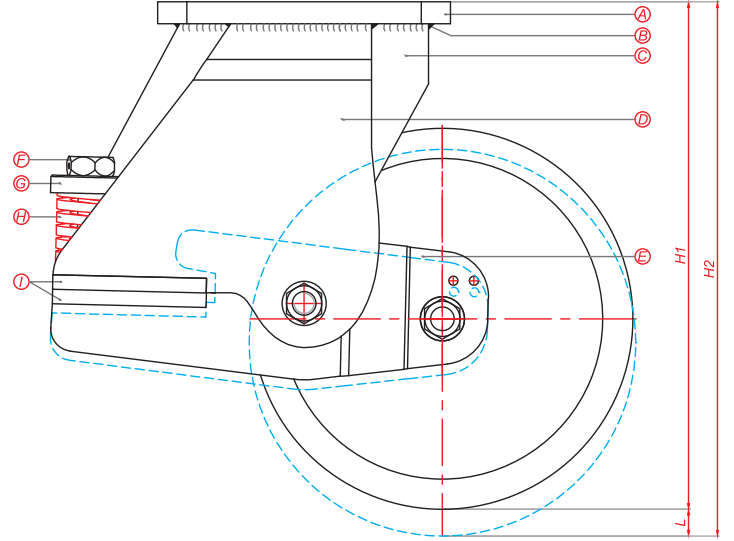

DOR

DÖKÜM KASNAK ÜZERİ DÖKME POLİÜRETAN KAPLAMA RULMANLI

KOD NO	mm	mm	mm	mm	mm	mm	mm	MAKSİMUM TAŞIMA KAPASİTESİ kg	ÖN GERME KUVVETİ kg	H2 TOPLAM YÜKSEKLİK mm	H1 YÜKLÜ TOPLAM YÜKSEKLİK mm	L YAY YOLU mm	YAYIN SON KUVVETİ kg
AD6707 DOR 270	270	2x80	224	95	250x200	210x160	17	5000	1000	355	345	10	5000

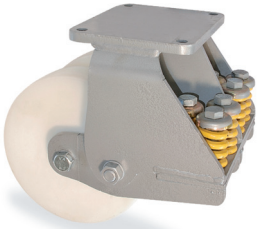

RPR

AĞIR TİP POLİAMİD TEKER RULMANLI

KOD NO	mm	mm	mm	mm	mm	mm	mm	MAKSİMUM TAŞIMA KAPASİTESİ kg	ÖN GERME KUVVETİ kg	H2 TOPLAM YÜKSEKLİK mm	H1 YÜKLÜ TOPLAM YÜKSEKLİK mm	L YAY YOLU mm	YAYIN SON KUVVETİ kg
AD6707 RPR 270	270	2x70	224	95	250x200	210x160	17	5000	1000	355	345	10	5000

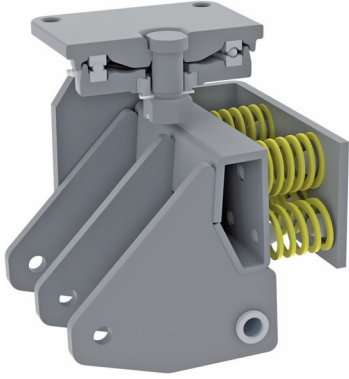

- A:** DÖVME OYNAK TABLA
- B:** BÜTE RULMAN
- C:** DÖVME ÜST BİLYA ÇANAĞI
- D:** TABLA CİVATASI
- E:** KONİK RULMAN
- F:** MAŞA AYAK KAYNAĞI
- G:** METAL MUHAFAZA TOZLUK
- H:** AYARLANABİLİR TAÇLI SOMUN
- I:** YARIKLI PİM
- J:** MAŞA AYAĞI
- K:** V KAPAMA PLAKASI
- L:** HAREKETLİ MAŞA AYAĞI
- M:** GRESÖRLÜK
- N:** U YAY PLAKASI
- O:** YAY TOPUZU
- P:** AMORTİSÖR YAYI

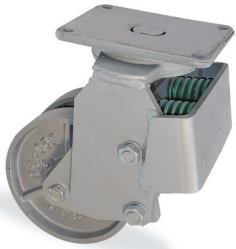
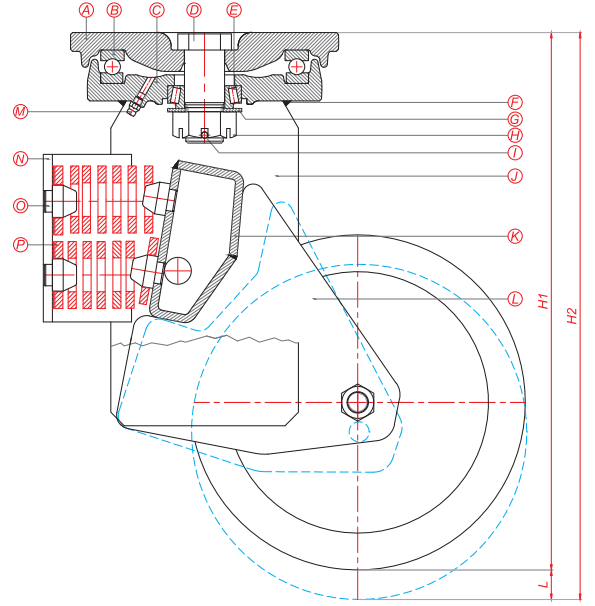

DDR		DÖKÜM TEKER RULMANLI											
KOD NO	mm	mm	mm	mm	mm	mm	mm	MAKSİMUM TAŞIMA KAPASİTESİ kg	ÖN GERME KUVVETİ kg	H2 TOPLAM YÜKSEKLİK mm	H1 YÜKLÜ TOPLAM YÜKSEKLİK mm	L YAY YOLU mm	YAYIN SON KUVVETİ kg
AY6702 DDR 250	250	2x50	155	115	250x200	210x160	17	2600	250	401	361	34	1900

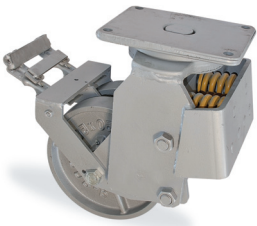

DDR		DÖKÜM TEKER RULMANLI												
KOD NO	mm	mm	mm	mm	mm	mm	mm	MAKSİMUM TAŞIMA KAPASİTESİ kg	ÖN GERME KUVVETİ kg	H2 TOPLAM YÜKSEKLİK mm	H1 YÜKLÜ TOPLAM YÜKSEKLİK mm	L YAY YOLU mm	YAYIN SON KUVVETİ kg	
AY6702 DDR 250 F04	250	2x50	155	115	345	250x200	210x160	17	2600	250	401	361	34	1900

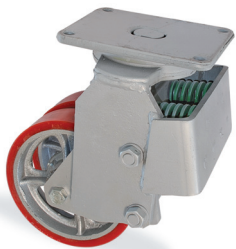





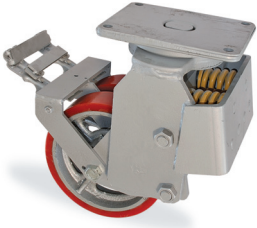



DOR		DÖKÜM KASNAK ÜZERİ DÖKME POLİÜRETAN KAPLAMA RULMANLI											
KOD NO	mm	mm	mm	mm	mm	mm	mm	MAKSİMUM TAŞIMA KAPASİTESİ kg	ÖN GERME KUVVETİ kg	H2 TOPLAM YÜKSEKLİK mm	H1 YÜKLÜ TOPLAM YÜKSEKLİK mm	L YAY YOLU mm	YAYIN SON KUVVETİ kg
AY6702 DOR 250	250	2x60	155	115	250x200	210x160	17	2700	250	401	361	34	1900
AY6702 DOR 260	260	2x65	155	115	250x200	210x160	17	2800	250	406	371	34	1900

AY6702 Serisi (Amortisörlü)



DOR





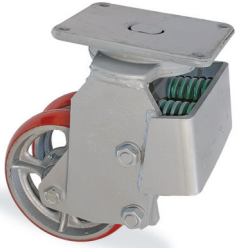

DÖKÜM KASNAK ÜZERİ DÖKME POLİÜRETAN KAPLAMA RULMANLI

KOD NO									MAKSİMUM TAŞIMA KAPASİTESİ kg	ÖN GERME KUVVETİ kg	H2 TOPLAM YÜKSEKLİK mm	H1 YÜKLÜ TOPLAM YÜKSEKLİK mm	L YAY YOLU mm	YAYIN SON KUVVETİ kg
AY6702 DOR 250 F04	250	2x60	155	115	345	250x200	210x160	17	2700	250	401	361	34	1900
AY6702 DOR 260 F04	260	2x65	155	115	345	250x200	210x160	17	2800	250	406	371	34	1900



D2OR





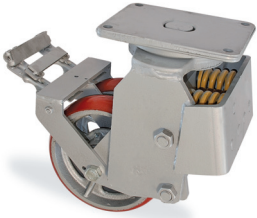

DÖKÜM KASNAK ÜZERİ OVAL DÖKME POLİÜRETAN KAPLAMA RULMANLI

KOD NO								MAKSİMUM TAŞIMA KAPASİTESİ kg	ÖN GERME KUVVETİ kg	H2 TOPLAM YÜKSEKLİK mm	H1 YÜKLÜ TOPLAM YÜKSEKLİK mm	L YAY YOLU mm	YAYIN SON KUVVETİ kg
AY6702 D2OR 250	250	2x60	155	115	250x200	210x160	17	2700	250	401	361	34	1900
AY6702 D2OR 260	260	2x65	155	115	250x200	210x160	17	2800	250	406	371	34	1900



D2OR





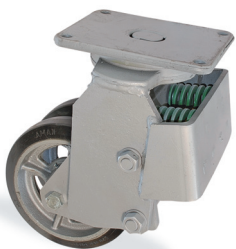

DÖKÜM KASNAK ÜZERİ OVAL DÖKME POLİÜRETAN KAPLAMA RULMANLI

KOD NO								MAKSİMUM TAŞIMA KAPASİTESİ kg	ÖN GERME KUVVETİ kg	H2 TOPLAM YÜKSEKLİK mm	H1 YÜKLÜ TOPLAM YÜKSEKLİK mm	L YAY YOLU mm	YAYIN SON KUVVETİ kg	
AY6702 D2OR 250 F04	250	2x60	155	115	345	250x200	210x160	17	2700	250	401	361	34	1900
AY6702 D2OR 260 F04	260	2x65	155	115	345	250x200	210x160	17	2800	250	406	371	34	1900







D2OR

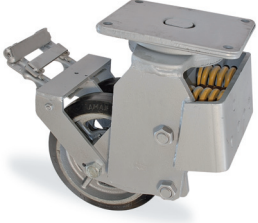





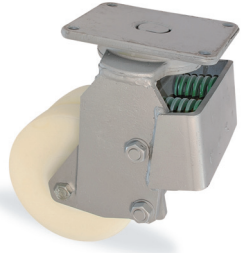

DÖKÜM KASNAK ÜZERİ VULKANİZE LASTİK KAPLAMA RULMANLI

KOD NO								MAKSİMUM TAŞIMA KAPASİTESİ kg	ÖN GERME KUVVETİ kg	H2 TOPLAM YÜKSEKLİK mm	H1 YÜKLÜ TOPLAM YÜKSEKLİK mm	L YAY YOLU mm	YAYIN SON KUVVETİ kg
AY6702 D2OR 250	250	2x60	155	115	250x200	210x160	17	1000	250	401	361	34	1900











DYP		DÖKÜM KASNAK ÜZERİ VULKANİZE LASTİK KAPLAMA RULMANLI												
KOD NO									MAKSİMUM TAŞIMA KAPASİTESİ	ÖN GERME KUVVETİ	H2 TOPLAM YÜKSEKLİK	H1 YÜKLÜ TOPLAM YÜKSEKLİK	L YAY YOLU	YAYIN SON KUVVETİ
	mm	mm	mm	mm	mm	mm	mm	mm	kg	kg	mm	mm	mm	kg
AY6702 DYP 250 F04	250	2x60	155	115	345	250x200	210x160	17	1000	250	401	361	34	1900



RPR		AĞIR TİP POLİAMİD TEKER RULMANLI												
KOD NO									MAKSİMUM TAŞIMA KAPASİTESİ	ÖN GERME KUVVETİ	H2 TOPLAM YÜKSEKLİK	H1 YÜKLÜ TOPLAM YÜKSEKLİK	L YAY YOLU	YAYIN SON KUVVETİ
	mm	mm	mm	mm	mm	mm	mm	mm	kg	kg	mm	mm	mm	kg
AY6702 RPR 250	250	2x60	155	115	250x200	210x160	17	2200	250	401	361	34	1900	



RPR		AĞIR TİP POLİAMİD TEKER RULMANLI												
KOD NO									MAKSİMUM TAŞIMA KAPASİTESİ	ÖN GERME KUVVETİ	H2 TOPLAM YÜKSEKLİK	H1 YÜKLÜ TOPLAM YÜKSEKLİK	L YAY YOLU	YAYIN SON KUVVETİ
	mm	mm	mm	mm	mm	mm	mm	mm	kg	kg	mm	mm	mm	kg
AY6702 RPR 250 F04	250	2x60	155	115	345	250x200	210x160	17	2200	250	401	361	34	1900

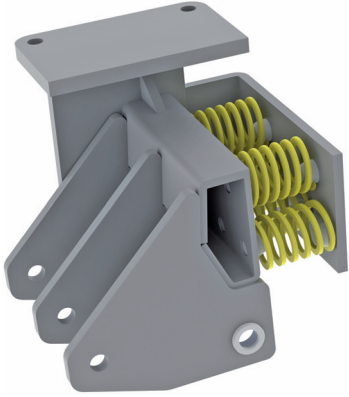

- A:** DÖVME SABİT TABLA
- B:** MAŞA AYAĞI
- C:** MAŞA AYAK KAYNAĞI
- D:** V KAPAMA PLAKASI
- E:** HAREKETLİ MAŞA AYAĞI
- F:** U YAY PLAKASI
- G:** YAY TOPUZU
- H:** AMORTİSÖR YAYI

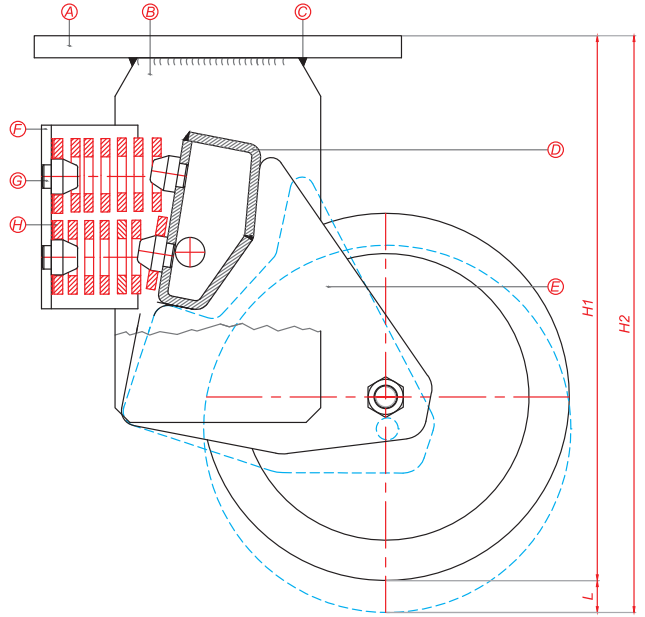

DDR

DÖKÜM TEKER RULMANLI

KOD NO								MAKSİMUM TAŞIMA KAPASİTESİ kg	ÖN GERME KUVVETİ kg	H2 TOPLAM YÜKSEKLİK mm	H1 YÜKLÜ TOPLAM YÜKSEKLİK mm	L YAY YOLU mm	YAYIN SON KUVVETİ kg
AY6707 DDR 250	250	2x50	155	115	250x200	210x160	17	2600	250	401	361	34	1900

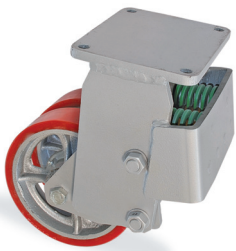

DOR

DÖKÜM KASNAK ÜZERİ DÖKME POLİÜRETAN KAPLAMA RULMANLI

KOD NO								MAKSİMUM TAŞIMA KAPASİTESİ kg	ÖN GERME KUVVETİ kg	H2 TOPLAM YÜKSEKLİK mm	H1 YÜKLÜ TOPLAM YÜKSEKLİK mm	L YAY YOLU mm	YAYIN SON KUVVETİ kg
AY6707 DOR 250	250	2x60	155	115	250x200	210x160	17	2700	250	401	361	34	1900
AY6707 DOR 260	260	2x65	155	115	250x200	210x160	17	2800	250	406	371	34	1900

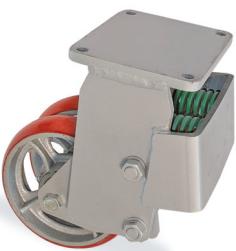

D2OR





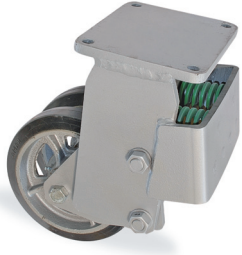

DÖKÜM KASNAK ÜZERİ OVAL DÖKME POLİÜRETAN KAPLAMA RULMANLI

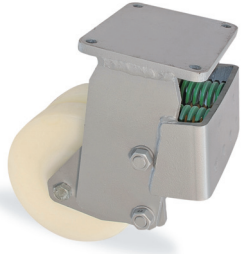
KOD NO								MAKSİMUM TAŞIMA KAPASİTESİ kg	ÖN GERME KUVVETİ kg	H2 TOPLAM YÜKSEKLİK mm	H1 YÜKLÜ TOPLAM YÜKSEKLİK mm	L YAY YOLU mm	YAYIN SON KUVVETİ kg
AY6707 D2OR 250	250	2x60	155	115	250x200	210x160	17	2700	250	401	361	34	1900
AY6707 D2OR 260	260	2x65	155	115	250x200	210x160	17	2800	250	406	371	34	1900



DYP		DÖKÜM KASNAK ÜZERİ VULKANİZE LASTİK KAPLAMA RULMANLI											
KOD NO	 mm	 mm	 mm	 mm	 mm	 mm	 mm	MAKSİMUM TAŞIMA KAPASİTESİ kg	ÖN GERME KUVVETİ kg	H2 TOPLAM YÜKSEKLİK mm	H1 YÜKLÜ TOPLAM YÜKSEKLİK mm	L YAY YOLU mm	YAYIN SON KUVVETİ kg
AY6707 DYP 250	250	2x60	155	115	250x200	210x160	17	1000	250	401	361	34	1900



RPR		AĞIR TİP POLİAMİD TEKER RULMANLI											
KOD NO	 mm	 mm	 mm	 mm	 mm	 mm	 mm	MAKSİMUM TAŞIMA KAPASİTESİ kg	ÖN GERME KUVVETİ kg	H2 TOPLAM YÜKSEKLİK mm	H1 YÜKLÜ TOPLAM YÜKSEKLİK mm	L YAY YOLU mm	YAYIN SON KUVVETİ kg
AY6707 RPR 250	250	2x60	155	115	250x200	210x160	17	2200	250	401	361	34	1900

SERİLERDE KULLANILAN TABLA ÖLÇÜLERİ

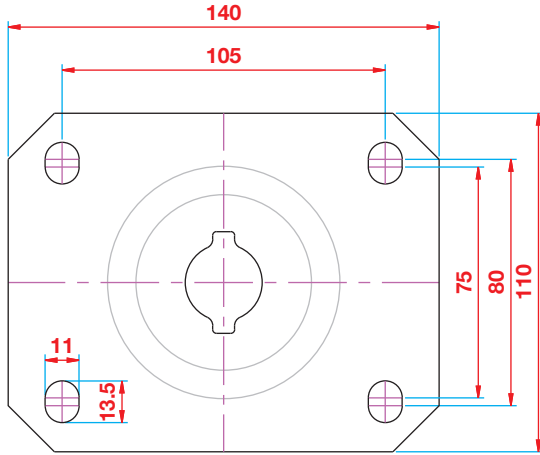

4102

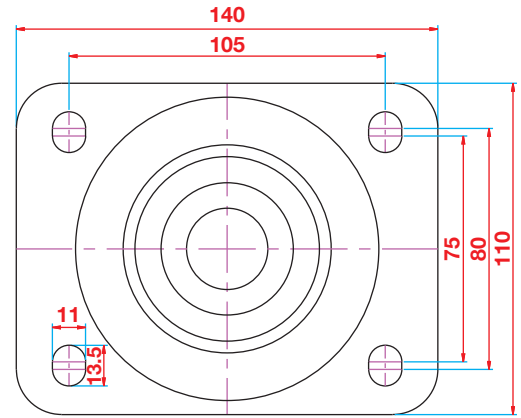

4302 / AY4302 / AD4302

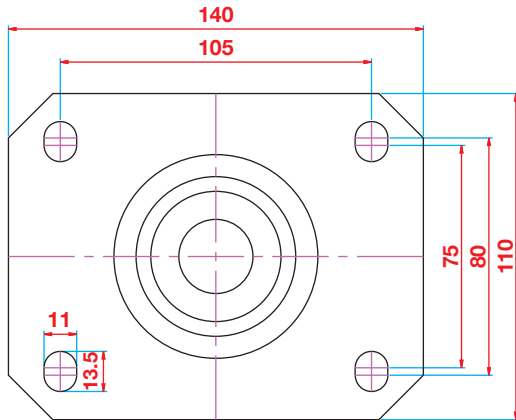

4402

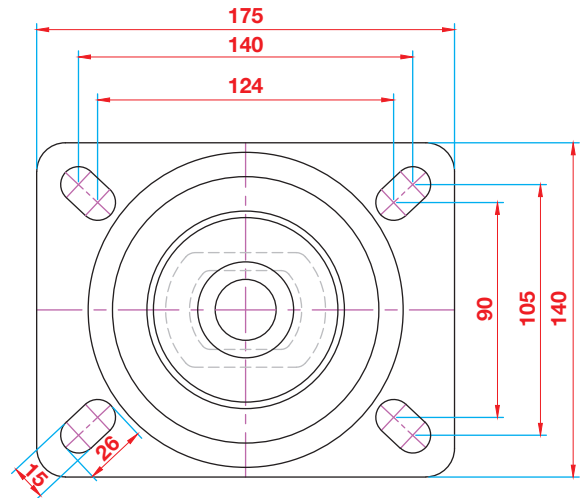

5102 / AY5102 / 5702

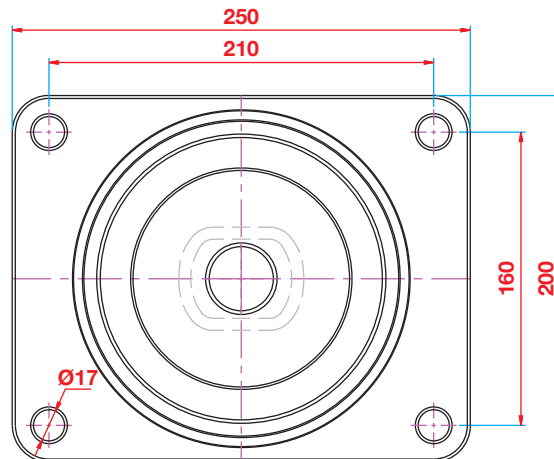

6702 / AY6702 / AD6702

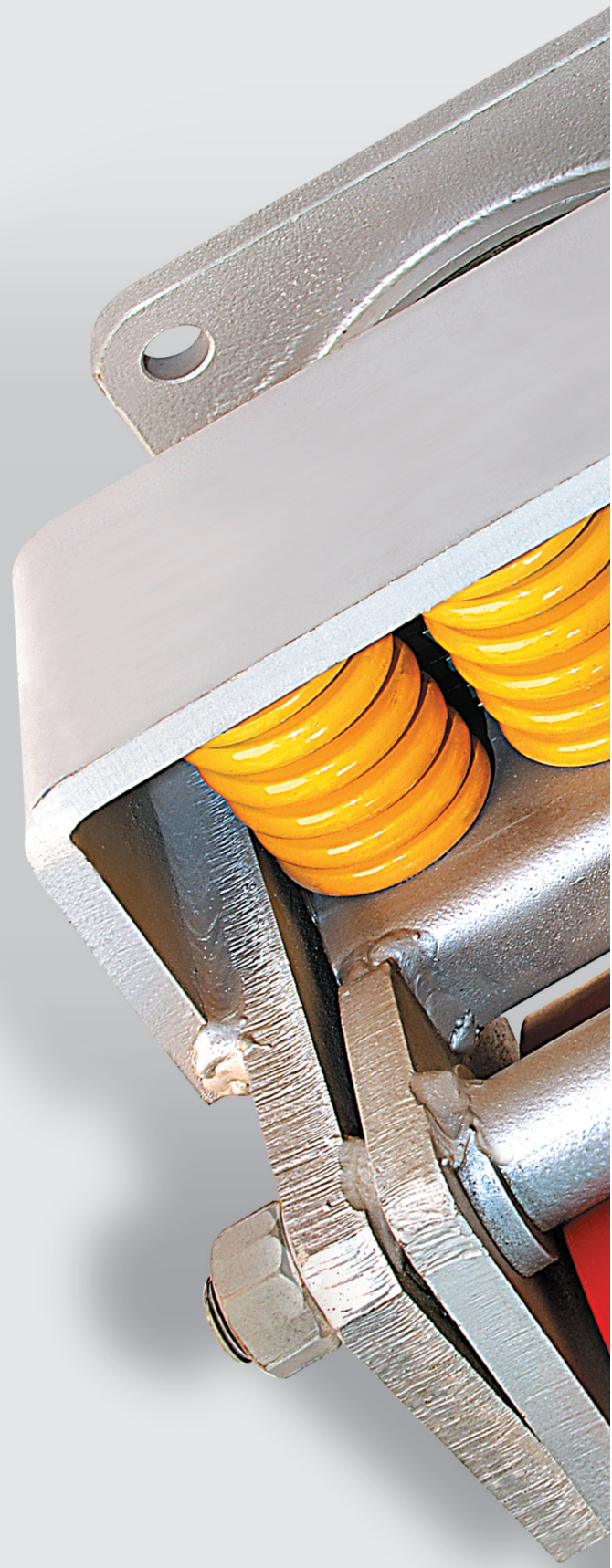

KAMA PRES SANAYİ ve TİCARET A.Ş.

Evren Mahallesi Gülbahar Caddesi No: 92
34212 Bağcılar - İSTANBUL - TURKEY

Tel: +90 (212) 655 21 00 PBX • Fax: +90 (212) 550 35 29

www.kama.com.tr • e-mail: satis@kama.com.tr

