

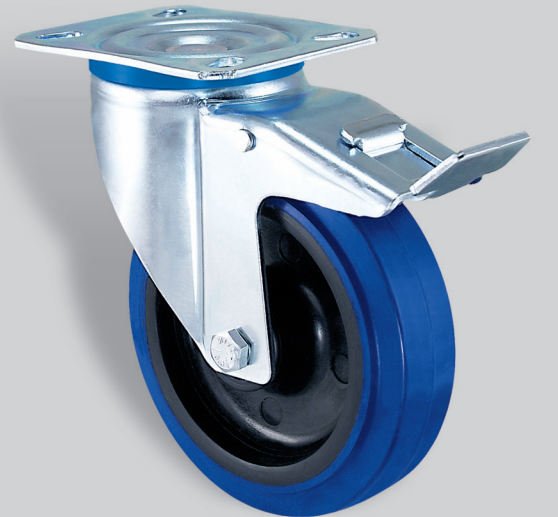

ORTA SANAYİ TAŞIMA RULETLERİ



90-600kg Taşıma Kapasitesi

[İÇİNDEKİLER]



2200 Serisi 1



2300 Serisi 2-3



2400 Serisi 5-7



AD2400 Serisi (Amortisörlü) 8-12



2500 Serisi 13-15



2600 Serisi 16



P2800 Serisi 17-21



2800 Serisi 22-58



3200 Serisi 59-67



S3200 Serisi (Paslanmaz) 68-78



3300 Serisi 79-153



S3300 Serisi (Paslanmaz) 154-169



3600 Serisi 170-180





3800 Serisi 181-216

RULET KODLAMA SİSTEMİ

S	32	02	D	2	O	R	150	F09	T
ÖN KOD	SERİ KODU	BAĞLANTI TİPİ	GÖVDE CİNSİ	SIRT TİPİ	SIRT MALZEMESİ	YATAK TİPİ	TEKER ÇAP (Ømm)	FREN SİSTEMİ	İLAVE BİLGİ HANESİ
AY AMORTİSÖR (YATAY)	22	00 DELİKLİ	A POLİAMİD 66	1 U PROFİLLİ SIRT (F14-MARKET TİPİ)	A POLİAMİD 66	A	064	F09	T
AD AMORTİSÖR (DİKEY)	23	01 CİVATA	B İSİYA DAYANIKLI BAKALİT	2 DERİN RADÜSLÜ (OVAL) SIRT TİPİ	B BAKALİT +250°C	B BURÇ YATAKLAMASI GÖVDENİN KENDİ	080	F18	SAC JANT KAPAKLI
S PASLANMAZ	24	02 TABLA	C TAKVİYELİ PP	3 ÜÇ KANALLI SIRT FORMLU (MARKET TİPİ)	C PLASTİK (P.V.C.)	C İSİYA DAYANIKLI BURÇ	100	F23	K
	25	05 PİM	D PİK (DÖKÜM)	4 U PROFİLLİ GÖVDEDEN BOMBELİ (F16-MARKET TİPİ)	D PİK (DÖKÜM)	D DEMİR BURÇ	125		KARE SOKET
	26	07 SABİT MAŞA	E SFERO (DÖKÜM)		E GRİ LASTİK	E	140		YUVARLAK SOKET
	28	15 BORULU	F POLİAMİD 6 KÜTÜK		F POLİAMİD 6 KÜTÜK	F	150		ATLAS KAPAK
	32	17 SOKET	G		G	G	160		
	33	18 LAMA	H POLİKARBONAT		H HAVALI LASTİK	H	170		
	36	25 AYARLI BAŞLIK (OYNAK)	I		I SİLİKON LASTİK +250°C	I	180		
	38	27 AYARLI BAŞLIK (SABİT)	K KAMALON		K	K	200		
			L		L SİYAH LASTİK	L	250		
			M POLİPROPİLEN		M POLİPROPİLEN	M DİZME MİSKET BİLYALI YATAKLAMA	260		
			N TAKVİYELİ POLİAMİD 6		N TAKVİYELİ POLİAMİD 6	N	280		
			O		O DÖKME POLİÜRETAN	O			
			P POLİAMİD 6		P POLİAMİD 6	P POLİAMİD BURÇLU YATAKLAMA			
			R AĞIR TİP		R MAVİ LASTİK	R BİLYA RULMANLI YATAKLAMA			
			S SAC		S YARI HAVALI (DUBLEKS) LASTİK	S MASURALI YATAKLAMA			
			T		T TERMOELASTİK LASTİK	T			
			U ENJEKSİYON BASKI POLİÜRETAN		U ENJEKSİYON BASKI POLİÜRETAN	U			
			V		V VULKANİZE LASTİK	V			
			Y		Y AĞIR TİP VULKANİZE LASTİK	Y			
			Z ALAŞIMLI ALÜMİNYUM		Z VULKATAN	Z			
					X ELASTAN	X			

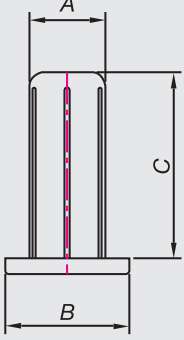
BAĞLANTI BAŞLIKLARI





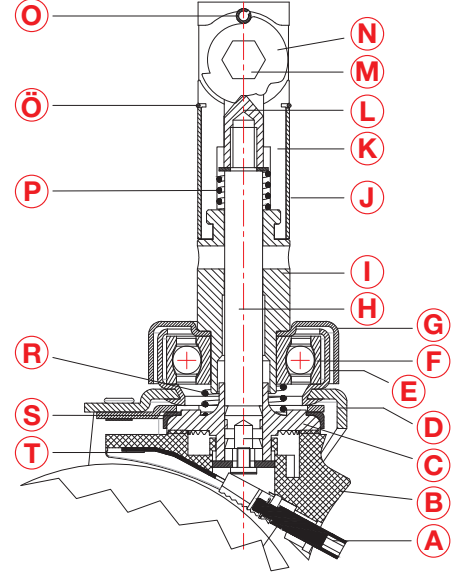

Soketler	A mm	B mm	C mm	KOD	Kullanıldığı Seriler	
		Ø 19-22 Ø 20-23 Ø 21.5-24 Ø 24-27 Ø 27-30	YUVARLAK SOKET YUVARLAK SOKET YUVARLAK SOKET YUVARLAK SOKET YUVARLAK SOKET	50 50 50 50 50	90 - 018 90 - 033 90 - 023 90 - 024 90 - 025	2825-2827-3325-S3325 2825-2827-3325-S3325 2825-2827-3325-S3325 2825-2827-3325-S3325 2825-2827-3325-S3325
		∅ 19-21.5 ∅ 21.5-24 ∅ 24-27 ∅ 27-30 ∅ 35-40	KARE SOKET KARE SOKET KARE SOKET KARE SOKET KARE SOKET	50 40 50 50 50	90 - 030 90 - 026 90 - 027 90 - 028 90 - 029	2825-2827-3325-S3325 2825-2827-3325-S3325 2825-2827-3325-S3325 2825-2827-3325-S3325 2825-2827-3325-S3325

- A:** AYAR SETİSKURU
B: FREN PABUCU
C: ALIN FREN DİŞLİSİ
D: MAŞA GÖVDESİ
E: RULMAN MUHAFAZASI
F: RULMAN
G: ÜST BİLYA KAPAĞI
H: MERKEZ KİLİT ANA MİLİ
I: MONTAJ HALKASI
J: MUHAFAZA SİLİNDİRİ
K: ZAMAK DIŞ KOVAN
L: KAM MİLİ TAKIP UCU
M: AK DELİK
N: AK YATAKLAMALI DIŞ KAM MİLİ
O: YARIKLI PİM
P: EMNİYET SEKMANI
R: KİLİT BASKI YAYI
S: FREN DİŞLİSİ BASKI YAYI
T: AYAR SETİSKURU
T: AYAR AMAÇLI LAMA YAYI









150°'LİK PLASTİK GIYDIRMELİ ÜRÜNLERİMİZİN SONUNA "T1" KODU EKLENMEKTEDİR.







MRR
MOBLEN KASNAK ÜZERİ KAUKUK LASTİK KAPLAMA RULMANLI

KOD NO	 mm	 mm	 mm	 mm	 mm	 mm	 kg
2217 MRR 125 F23 (ÜÇ KADEMELİ)	125	32	171.5	39.5	28	97.5	110
2217 MRR 150 F23 (ÜÇ KADEMELİ)	150	32	185	44.5	28	97.5	130
2217 MRR 200 F23 (ÜÇ KADEMELİ)	200	32	245	56	28	97.5	140

MTR
MOBLEN KASNAK ÜZERİ TERMOELASTİK KAPLAMA RULMANLI

KOD NO	 mm	 mm	 mm	 mm	 mm	 mm	 kg
2217 MTR 125 F23 (ÜÇ KADEMELİ)	125	32	171.5	39.5	28	97.5	110
2217 MTR 150 F23 (ÜÇ KADEMELİ)	150	32	185	44.5	28	97.5	130
2217 MTR 200 F23 (ÜÇ KADEMELİ)	200	32	245	56	28	97.5	140





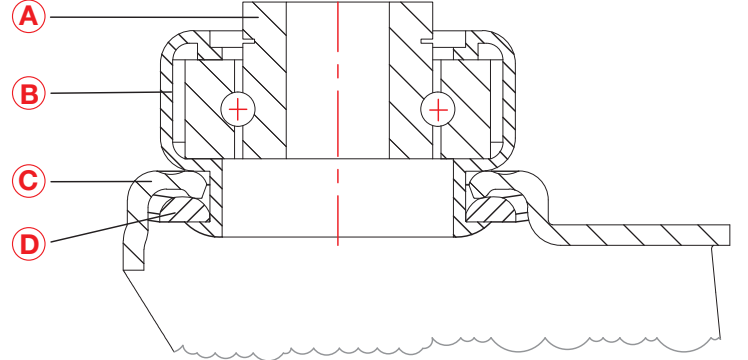

PUR
POLİAMİD KASNAK ÜZERİ POLİÜRETAN KAPLAMA RULMANLI

KOD NO	 mm	 mm	 mm	 mm	 mm	 mm	 kg
2217 PUR 125 F23 (ÜÇ KADEMELİ)	125	32	171.5	39.5	28	97.5	110
2217 PUR 150 F23 (ÜÇ KADEMELİ)	150	32	185	44.5	28	97.5	130
2217 PUR 200 F23 (ÜÇ KADEMELİ)	200	32	245	56	28	97.5	140







* BU SERİMİZ F21 TEK KADEMELİ OLARAK DA MEVCUTTUR.

- A:** RULMAN
B: RULMAN MUHAFAZA KAPAĞI
C: RULET MAŞASI
D: MONTAJ RONDELASI







**MTR****MOBLEN KASNAK ÜZERİ TERMOELASTİK KAPLAMA RULMANLI**

KOD NO	 mm	 mm	 mm	 mm	 mm	 kg
2300 MTR 080	80	32	118	39	12.5	90
2300 MTR 100	100	32	142	42	12.5	100
2300 MTR 125	125	32	167	40	12.5	110
2300 MTR 150	150	32	192	51	12.5	130
2300 MTR 200	200	32	246	55	12.5	140







**MTR****MOBLEN KASNAK ÜZERİ TERMOELASTİK KAPLAMA RULMANLI**

KOD NO	 mm	 mm	 mm	 mm	 mm	 mm	 kg
2300 MTR 080 F18	80	32	118	39	122	12.5	90
2300 MTR 100 F18	100	32	142	42	122	12.5	100
2300 MTR 125 F18	125	32	167	40	123	12.5	110
2300 MTR 150 F18	150	32	192	51	154	12.5	130
2300 MTR 200 F18	200	32	246	55	154	12.5	140

**PUR****POLİAMİD KASNAK ÜZERİ POLİÜRETAN KAPLAMA RULMANLI**

KOD NO	 mm	 mm	 mm	 mm	 mm	 kg
2300 PUR 080	80	32	118	39	12.5	90
2300 PUR 100	100	32	142	42	12.5	100
2300 PUR 125	125	32	167	40	12.5	110
2300 PUR 150	150	32	192	51	12.5	130
2300 PUR 200	200	32	246	55	12.5	140



PUR		POLİAMİD KASNAK ÜZERİ POLİÜRETAN KAPLAMA RULMANLI					
KOD NO	 mm	 mm	 mm	 mm	 mm	 mm	 kg
2300 PUR 080 F18	80	32	118	39	122	12.5	90
2300 PUR 100 F18	100	32	142	42	122	12.5	100
2300 PUR 125 F18	125	32	167	40	123	12.5	110
2300 PUR 150 F18	150	32	192	51	154	12.5	130
2300 PUR 200 F18	200	32	246	55	154	12.5	140









MLR		MOBLEN KASNAK ÜZERİ KAÇUK LASTİK KAPLAMA RULMANLI					
KOD NO	 mm	 mm	 mm	 mm	 mm	 mm	 kg
2300 MLR 100	100	28	142	42	12.5		100
2300 MLR 125	125	32	167	40	12.5		110
2300 MLR 150	150	32	192	51	12.5		130







MLR		MOBLEN KASNAK ÜZERİ KAÇUK LASTİK KAPLAMA RULMANLI					
KOD NO	 mm	 mm	 mm	 mm	 mm	 mm	 kg
2300 MLR 100 F18	100	28	142	42	122	12.5	100
2300 MLR 125 F18	125	32	167	40	123	12.5	110
2300 MLR 150 F18	150	32	192	51	154	12.5	130









PUR		POLİAMİD KASNAK ÜZERİ POLİÜRETAN KAPLAMA RULMANLI				
KOD NO	 mm	 mm	 mm	 mm	 mm	 kg
2300 PUR 125 F10	125	32	164	40		110



PUR		POLİAMİD KASNAK ÜZERİ POLİÜRETAN KAPLAMA RULMANLI				
KOD NO	 mm	 mm	 mm	 mm	 mm	 kg
2300 PUR 125 F16	125	32	164	40		110



UUR		RULMANLI, ENJEKSİYON POLİÜRETAN MARKET TEKERİ				
KOD NO	 mm	 mm	 mm	 mm	 mm	 kg
2300 UUR 125 F10	125	32	164	40		110

- A: LAMA
- B: RULMAN
- C: RULMAN MUHAFAZA KAPAĞI
- D: PUL
- E: RULET MAŞASI
- F: MONTAJ RONDELASI

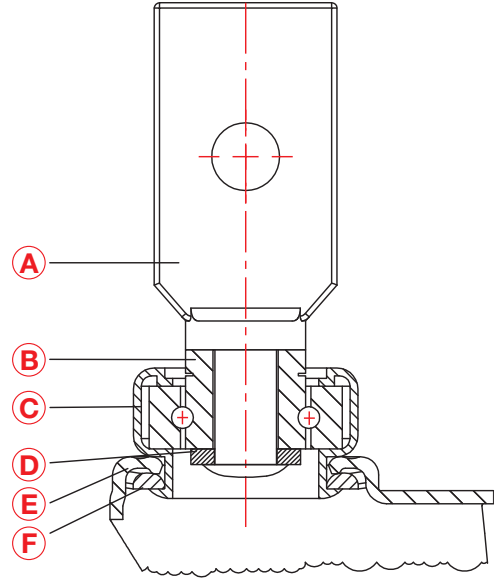

PUR		POLİAMİD KASNAK ÜZERİ POLİÜRETAN KAPLAMA RULMANLI			
KOD NO	mm	mm	mm	mm	kg
2318 PUR 125 F10	125	32	164	40	110



PUR		POLİAMİD KASNAK ÜZERİ POLİÜRETAN KAPLAMA RULMANLI			
KOD NO	mm	mm	mm	mm	kg
2318 PUR 125 F16	125	32	164	40	110

- A:** OYNAK BAĞLANTI TABLASI
- B:** TABLA PERÇİNİ
- C:** ÜST BİLYA KAPAĞI
- D:** KÜRESEL METAL TANE BİLYALAR
- E:** ÜST VE ALT BİLYA KAFESİ
- F:** MAŞA ÇANAĞI
- G:** OYNAK RULET MAŞASI
- H:** ALT BİLYA ÇANAĞI
- I:** MONTAJ SOMUNU

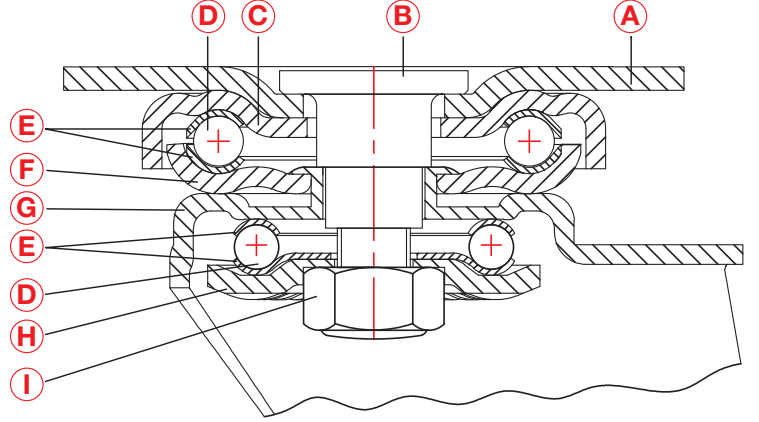

MLR		MOBLEN KASNAK ÜZERİ KAUÇUK LASTİK KAPLAMA RULMANLI						
KOD NO								
	mm	mm	mm	mm	mm	mm	mm	kg
2402 MLR 100	100	28	137	42	79x70	60x50	8.3x9.6	100
2402 MLR 125	125	32	162	40	79x70	60x50	8.3x9.6	110
2402 MLR 150	150	32	187	51	79x70	60x50	8.3x9.6	130



MLR		MOBLEN KASNAK ÜZERİ KAUÇUK LASTİK KAPLAMA RULMANLI							
KOD NO									
	mm	mm	mm	mm	mm	mm	mm	mm	kg
2402 MLR 100 F18	100	28	137	42	122	79x70	60x50	8.3x9.6	100
2402 MLR 125 F18	125	32	162	40	123	79x70	60x50	8.3x9.6	110
2402 MLR 150 F18	150	32	187	51	154	79x70	60x50	8.3x9.6	130









MTR		MOBLEN KASNAK ÜZERİ TERMOELASTİK KAPLAMA RULMANLI						
KOD NO								
	mm	mm	mm	mm	mm	mm	mm	kg
2402 MTR 080	80	32	113	39	79x70	60x50	8.3x9.6	90
2402 MTR 100	100	32	137	42	79x70	60x50	8.3x9.6	100
2402 MTR 125	125	32	162	40	79x70	60x50	8.3x9.6	110









MTR		MOBLEN KASNAK ÜZERİ TERMOELASTİK KAPLAMA RULMANLI							
KOD NO									
	mm	mm	mm	mm	mm	mm	mm	mm	kg
2402 MTR 080 F18	80	32	113	39	122	79x70	60x50	8.3x9.6	90
2402 MTR 100 F18	100	32	137	42	122	79x70	60x50	8.3x9.6	100
2402 MTR 125 F18	125	32	162	40	123	79x70	60x50	8.3x9.6	110



MTR		MOBLEN KASNAK ÜZERİ TERMOELASTİK KAPLAMA RULMANLI						
KOD NO								kg
2402 MTR 150	150	32	187	51	79x70	60x50	8.3x9.6	130
2402 MTR 200	200	32	238	55	79x70	60x50	8.3x9.6	140



MTR		MOBLEN KASNAK ÜZERİ TERMOELASTİK KAPLAMA RULMANLI							
KOD NO								kg	
2402 MTR 150 F18	150	32	187	51	154	79x70	60x50	8.3x9.6	130
2402 MTR 200 F18	200	32	238	55	154	79x70	60x50	8.3x9.6	140



MRR		MOBLEN KASNAK ÜZERİ KAUÇUK LASTİK KAPLAMA RULMANLI						
KOD NO								kg
2402 MRR 100	100	28	137	42	79x70	60x50	8.3x9.6	100
2402 MRR 125	125	32	162	40	79x70	60x50	8.3x9.6	110



MRR		MOBLEN KASNAK ÜZERİ KAUÇUK LASTİK KAPLAMA RULMANLI							
KOD NO								kg	
2402 MRR 100 F18	100	28	137	42	122	79x70	60x50	8.3x9.6	100
2402 MRR 125 F18	125	32	162	40	123	79x70	60x50	8.3x9.6	110











MRR		MOBLEN KASNAK ÜZERİ KAUÇUK LASTİK KAPLAMA RULMANLI						
KOD NO								kg
2402 MRR 150	150	32	187	51	79x70	60x50	8.3x9.6	130
2402 MRR 200	200	32	238	55	79x70	60x50	8.3x9.6	140











MRR		MOBLEN KASNAK ÜZERİ KAUÇUK LASTİK KAPLAMA RULMANLI							
KOD NO								kg	
2402 MRR 150 F18	150	32	187	51	154	79x70	60x50	8.3x9.6	130
2402 MRR 200 F18	200	32	238	55	154	79x70	60x50	8.3x9.6	140



PUR		POLİAMİD KASNAK ÜZERİ POLİÜRETAN KAPLAMA RULMANLI						
KOD NO								
	mm	mm	mm	mm	mm	mm	mm	kg
2402 PUR 080	80	32	113	39	79x70	60x50	8.3x9.6	125
2402 PUR 100	100	32	137	42	79x70	60x50	8.3x9.6	150
2402 PUR 125	125	32	162	40	79x70	60x50	8.3x9.6	180





PUR		POLİAMİD KASNAK ÜZERİ POLİÜRETAN KAPLAMA RULMANLI							
KOD NO									
	mm	mm	mm	mm	mm	mm	mm	kg	
2402 PUR 080 F18	80	32	113	39	122	79x70	60x50	8.3x9.6	125
2402 PUR 100 F18	100	32	137	42	122	79x70	60x50	8.3x9.6	150
2402 PUR 125 F18	125	32	162	40	123	79x70	60x50	8.3x9.6	180



PUR		POLİAMİD KASNAK ÜZERİ POLİÜRETAN KAPLAMA RULMANLI						
KOD NO								
	mm	mm	mm	mm	mm	mm	mm	kg
2402 PUR 150	150	32	187	51	79x70	60x50	8.3x9.6	200
2402 PUR 200	200	32	238	55	79x70	60x50	8.3x9.6	220



PUR		POLİAMİD KASNAK ÜZERİ POLİÜRETAN KAPLAMA RULMANLI							
KOD NO									
	mm	mm	mm	mm	mm	mm	mm	kg	
2402 PUR 150 F18	150	32	187	51	154	79x70	60x50	8.3x9.6	200
2402 PUR 200 F18	200	32	238	55	154	79x70	60x50	8.3x9.6	220

AD2401 Serisi (Amortisörlü)

- A:** BAĞLANTI CİVATASI
- B:** ALTİGEN PUL
- C:** ÜST BİLYA KAPAĞI
- D:** CK60 MALZEME SERTLEŞTİRİLMİŞ BİLYA YATAĞI
- E:** KÜRESEL METAL TANE BİLYALAR
- F:** MAŞA ÇANAĞI
- G:** OYNAK RULET MAŞASI
- H:** ALT BİLYA ÇANAĞI
- I:** MONTAJ SOMUNU
- J:** AMORTİSÖR STROK AYAR SOMUNU
- K:** AMORTİSÖR YAYI

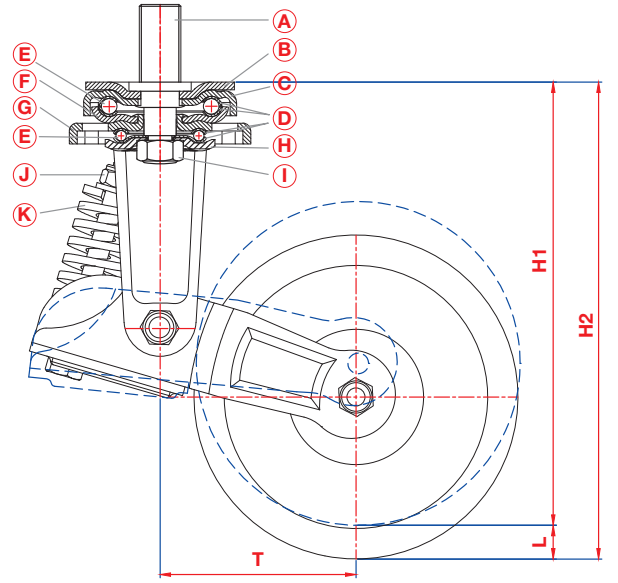

MLR

MOBLEN KASNAK ÜZERİ KAUÇUK LASTİK KAPLAMA RULMANLI

KOD NO						MAKSİMUM TAŞIMA KAPASİTESİ kg	ÖN GERME KUVVETİ kg	H2 TOPLAM YÜKSEKLİK mm	H1 YÜKLÜ TOPLAM YÜKSEKLİK mm	L YAY YOLU mm	YAYIN SON KUVVETİ kg
AD2401 MLR 100 M	100	28	64	M12	30	90	8	155	140	15	18
AD2401 MLR 100 K	100	28	64	M12	30	90	10	155	140	15	28
AD2401 MLR 100 S	100	28	64	M12	30	90	25	155	140	15	40
AD2401 MLR 125 M	125	32	75	M12	30	100	8	180	161	19	20
AD2401 MLR 125 K	125	32	75	M12	30	100	12	180	161	19	30
AD2401 MLR 125 S	125	32	75	M12	30	100	28	180	161	19	45

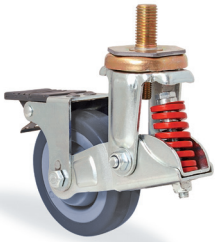

MLR





MOBLEN KASNAK ÜZERİ KAUÇUK LASTİK KAPLAMA RULMANLI

KOD NO							MAKSİMUM TAŞIMA KAPASİTESİ kg	ÖN GERME KUVVETİ kg	H2 TOPLAM YÜKSEKLİK mm	H1 YÜKLÜ TOPLAM YÜKSEKLİK mm	L YAY YOLU mm	YAYIN SON KUVVETİ kg
AD2401 MLR 100 F04 M	100	28	64	135	M12	30	90	8	155	140	15	18
AD2401 MLR 100 F04 K	100	28	64	135	M12	30	90	10	155	140	15	28
AD2401 MLR 100 F04 S	100	28	64	135	M12	30	90	25	155	140	15	40
AD2401 MLR 125 F04 M	125	32	75	146	M12	30	100	8	180	161	19	20
AD2401 MLR 125 F04 K	125	32	75	146	M12	30	100	12	180	161	19	30
AD2401 MLR 125 F04 S	125	32	75	146	M12	30	100	28	180	161	19	45



MTR





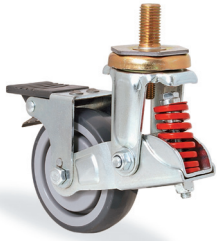

MOBLEN KASNAK ÜZERİ TERMOELASTİK KAPLAMA RULMANLI

KOD NO	 mm	 mm	 mm	 mm	 mm	MAKSİMUM TAŞIMA KAPASİTESİ kg	ÖN GERME KUVVETİ kg	H2 TOPLAM YÜKSEKLİK mm	H1 YÜKLÜ TOPLAM YÜKSEKLİK mm	L YAY YOLU mm	YAYIN SON KUVVETİ kg
AD2401 MTR 100 M	100	32	64	M12	30	100	8	155	140	15	18
AD2401 MTR 100 K	100	32	64	M12	30	100	10	155	140	15	28
AD2401 MTR 100 S	100	32	64	M12	30	100	25	155	140	15	40
AD2401 MTR 125 M	125	32	75	M12	30	120	8	180	161	19	20
AD2401 MTR 125 K	125	32	75	M12	30	120	12	180	161	19	30
AD2401 MTR 125 S	125	32	75	M12	30	120	28	180	161	19	45



MTR





MOBLEN KASNAK ÜZERİ TERMOELASTİK KAPLAMA RULMANLI

KOD NO	 mm	 mm	 mm	 mm	 mm	 mm	MAKSİMUM TAŞIMA KAPASİTESİ kg	ÖN GERME KUVVETİ kg	H2 TOPLAM YÜKSEKLİK mm	H1 YÜKLÜ TOPLAM YÜKSEKLİK mm	L YAY YOLU mm	YAYIN SON KUVVETİ kg
AD2401 MTR 100 F04 M	100	32	64	135	M12	30	100	8	155	140	15	18
AD2401 MTR 100 F04 K	100	32	64	135	M12	30	100	10	155	140	15	28
AD2401 MTR 100 F04 S	100	32	64	135	M12	30	100	25	155	140	15	40
AD2401 MTR 125 F04 M	125	32	75	146	M12	30	120	8	180	161	19	20
AD2401 MTR 125 F04 K	125	32	75	146	M12	30	120	12	180	161	19	30
AD2401 MTR 125 F04 S	125	32	75	146	M12	30	120	28	180	161	19	45



PUR





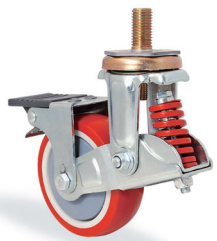

POLİAMİD KASNAK ÜZERİ POLİÜRETAN KAPLAMA RULMANLI

KOD NO	 mm	 mm	 mm	 mm	 mm	MAKSİMUM TAŞIMA KAPASİTESİ kg	ÖN GERME KUVVETİ kg	H2 TOPLAM YÜKSEKLİK mm	H1 YÜKLÜ TOPLAM YÜKSEKLİK mm	L YAY YOLU mm	YAYIN SON KUVVETİ kg
AD2401 PUR 100 M	100	32	64	M12	30	150	8	155	140	15	18
AD2401 PUR 100 K	100	32	64	M12	30	150	10	155	140	15	28
AD2401 PUR 100 S	100	32	64	M12	30	150	25	155	140	15	40
AD2401 PUR 125 M	125	32	75	M12	30	180	8	180	161	19	20
AD2401 PUR 125 K	125	32	75	M12	30	180	12	180	161	19	30
AD2401 PUR 125 S	125	32	75	M12	30	180	28	180	161	19	45



PUR

POLİAMİD KASNAK ÜZERİ POLİÜRETAN KAPLAMA RULMANLI

KOD NO	 mm	 mm	 mm	 mm	 mm	 mm	MAKSİMUM TAŞIMA KAPASİTESİ kg	ÖN GERME KUVVETİ kg	H2 TOPLAM YÜKSEKLİK mm	H1 YÜKLÜ TOPLAM YÜKSEKLİK mm	L YAY YOLU mm	YAYIN SON KUVVETİ kg
AD2401 PUR 100 F04 M	100	32	64	135	M12	30	150	8	155	140	15	18
AD2401 PUR 100 F04 K	100	32	64	135	M12	30	150	10	155	140	15	28
AD2401 PUR 100 F04 S	100	32	64	135	M12	30	150	25	155	140	15	40
AD2401 PUR 125 F04 M	125	32	75	146	M12	30	180	8	180	161	19	20
AD2401 PUR 125 F04 K	125	32	75	146	M12	30	180	12	180	161	19	30
AD2401 PUR 125 F04 S	125	32	75	146	M12	30	180	28	180	161	19	45

AD2402 Serisi (Amortisörlü)

- A:** BAĞLANTI TABLASI
- B:** TABLA CİVATASI
- C:** ÜST BİLYA KAPAĞI
- D:** CK60 MALZEME SERTLEŞTİRİLMİŞ BİLYA YATAĞI
- E:** KÜRESEL METAL TANE BİLYALAR
- F:** MAŞA ÇANAĞI
- G:** OYNAK RULET MAŞASI
- H:** ALT BİLYA ÇANAĞI
- I:** MONTAJ SOMUNU
- J:** AMORTİSÖR STROK AYAR SOMUNU
- K:** AMORTİSÖR YAYI

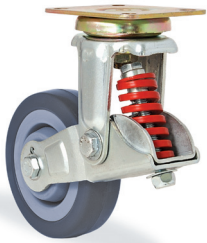
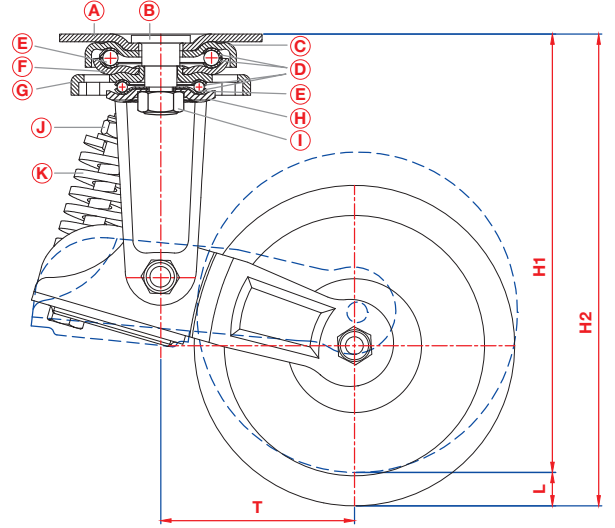

MLR		MOBLEN KASNAK ÜZERİ KAUÇUK LASTİK KAPLAMA RULMANLI										
KOD NO	mm	mm	mm	mm	mm	mm	MAKSİMUM TAŞIMA KAPASİTESİ kg	ÖN GERME KUVVETİ kg	H2 TOPLAM YÜKSEKLİK mm	H1 YÜKLÜ TOPLAM YÜKSEKLİK mm	L YAY YOLU mm	YAYIN SON KUVVETİ kg
AD2402 MLR 100 M	100	28	64	79x70	60x50	8.5	90	8	155	140	15	18
AD2402 MLR 100 K	100	28	64	79x70	60x50	8.5	90	10	155	140	15	28
AD2402 MLR 100 S	100	28	64	79x70	60x50	8.5	90	25	155	140	15	40
AD2402 MLR 125 M	125	32	75	79x70	60x50	8.5	100	8	180	161	19	20
AD2402 MLR 125 K	125	32	75	79x70	60x50	8.5	100	12	180	161	19	30
AD2402 MLR 125 S	125	32	75	79x70	60x50	8.5	100	28	180	161	19	45









MLR		MOBLEN KASNAK ÜZERİ KAUÇUK LASTİK KAPLAMA RULMANLI											
KOD NO	mm	mm	mm	mm	mm	mm	mm	MAKSİMUM TAŞIMA KAPASİTESİ kg	ÖN GERME KUVVETİ kg	H2 TOPLAM YÜKSEKLİK mm	H1 YÜKLÜ TOPLAM YÜKSEKLİK mm	L YAY YOLU mm	YAYIN SON KUVVETİ kg
AD2402 MLR 100 F04 M	100	28	64	135	79x70	60x50	8.5	90	8	155	140	15	18
AD2402 MLR 100 F04 K	100	28	64	135	79x70	60x50	8.5	90	10	155	140	15	28
AD2402 MLR 100 F04 S	100	28	64	135	79x70	60x50	8.5	90	25	155	140	15	40
AD2402 MLR 125 F04 M	125	32	75	146	79x70	60x50	8.5	100	8	180	161	19	20
AD2402 MLR 125 F04 K	125	32	75	146	79x70	60x50	8.5	100	12	180	161	19	30
AD2402 MLR 125 F04 S	125	32	75	146	79x70	60x50	8.5	100	28	180	161	19	45



MTR





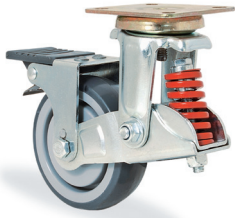

MOBLEN KASNAK ÜZERİ TERMOELASTİK KAPLAMA RULMANLI

KOD NO	 mm	 mm	 mm	 mm	 mm	 mm	MAKSİMUM TAŞIMA KAPASİTESİ kg	ÖN GERME KUVVETİ kg	H2 TOPLAM YÜKSEKLİK mm	H1 YÜKLÜ TOPLAM YÜKSEKLİK mm	L YAY YOLU mm	YAYIN SON KUVVETİ kg
AD2402 MTR 100 M	100	32	64	79x70	60x50	8.5	100	8	155	140	15	18
AD2402 MTR 100 K	100	32	64	79x70	60x50	8.5	100	10	155	140	15	28
AD2402 MTR 100 S	100	32	64	79x70	60x50	8.5	100	25	155	140	15	40
AD2402 MTR 125 M	125	32	75	79x70	60x50	8.5	120	8	180	161	19	20
AD2402 MTR 125 K	125	32	75	79x70	60x50	8.5	120	12	180	161	19	30
AD2402 MTR 125 S	125	32	75	79x70	60x50	8.5	120	28	180	161	19	45



MTR







MOBLEN KASNAK ÜZERİ TERMOELASTİK KAPLAMA RULMANLI

KOD NO	 mm	 mm	 mm	 mm	 mm	 mm	MAKSİMUM TAŞIMA KAPASİTESİ kg	ÖN GERME KUVVETİ kg	H2 TOPLAM YÜKSEKLİK mm	H1 YÜKLÜ TOPLAM YÜKSEKLİK mm	L YAY YOLU mm	YAYIN SON KUVVETİ kg	
AD2402 MTR 100 F04 M	100	32	64	135	79x70	60x50	8.5	100	8	155	140	15	18
AD2402 MTR 100 F04 K	100	32	64	135	79x70	60x50	8.5	100	10	155	140	15	28
AD2402 MTR 100 F04 S	100	32	64	135	79x70	60x50	8.5	100	25	155	140	15	40
AD2402 MTR 125 F04 M	125	32	75	146	79x70	60x50	8.5	120	8	180	161	19	20
AD2402 MTR 125 F04 K	125	32	75	146	79x70	60x50	8.5	120	12	180	161	19	30
AD2402 MTR 125 F04 S	125	32	75	146	79x70	60x50	8.5	120	28	180	161	19	45



PUR







POLİAMİD KASNAK ÜZERİ POLİÜRETAN KAPLAMA RULMANLI

KOD NO	 mm	 mm	 mm	 mm	 mm	 mm	MAKSİMUM TAŞIMA KAPASİTESİ kg	ÖN GERME KUVVETİ kg	H2 TOPLAM YÜKSEKLİK mm	H1 YÜKLÜ TOPLAM YÜKSEKLİK mm	L YAY YOLU mm	YAYIN SON KUVVETİ kg
AD2402 PUR 100 M	100	32	64	79x70	60x50	8.5	150	8	155	140	15	18
AD2402 PUR 100 K	100	32	64	79x70	60x50	8.5	150	10	155	140	15	28
AD2402 PUR 100 S	100	32	64	79x70	60x50	8.5	150	25	155	140	15	40
AD2402 PUR 125 M	125	32	75	79x70	60x50	8.5	180	8	180	161	19	20
AD2402 PUR 125 K	125	32	75	79x70	60x50	8.5	180	12	180	161	19	30
AD2402 PUR 125 S	125	32	75	79x70	60x50	8.5	180	28	180	161	19	45



PUR

POLİAMİD KASNAK ÜZERİ POLİÜRETAN KAPLAMA RULMANLI

KOD NO	 mm	 mm	 mm	 mm	 mm	 mm	MAKSİMUM TAŞIMA KAPASİTESİ kg	ÖN GERME KUVVETİ kg	H2 TOPLAM YÜKSEKLİK mm	H1 YÜKLÜ TOPLAM YÜKSEKLİK mm	L YAY YOLU mm	YAYIN SON KUVVETİ kg	
AD2402 PUR 100 F04 M	100	32	64	135	79x70	60x50	8.5	150	8	155	140	15	18
AD2402 PUR 100 F04 K	100	32	64	135	79x70	60x50	8.5	150	10	155	140	15	28
AD2402 PUR 100 F04 S	100	32	64	135	79x70	60x50	8.5	150	25	155	140	15	40
AD2402 PUR 125 F04 M	125	32	75	146	79x70	60x50	8.5	180	8	180	161	19	20
AD2402 PUR 125 F04 K	125	32	75	146	79x70	60x50	8.5	180	12	180	161	19	30
AD2402 PUR 125 F04 S	125	32	75	146	79x70	60x50	8.5	180	28	180	161	19	45

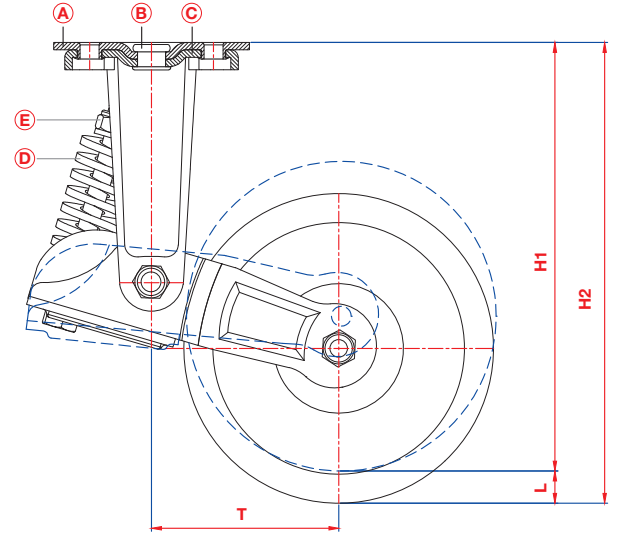

- A:** BAĞLANTI TABLASI
- B:** TABLA PERÇİNİ
- C:** SABİT MAŞA
- D:** AMORTİSÖR YAYI
- E:** AMORTİSÖR STROK AYAR SOMUNU

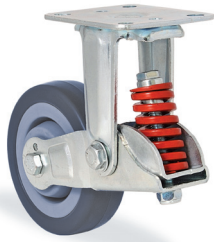

MLR		MOBLEN KASNAK ÜZERİ KAUÇUK LASTİK KAPLAMA RULMANLI										
KOD NO	mm	mm	mm	mm	mm	mm	MAKSİMUM TAŞIMA KAPASİTESİ kg	ÖN GERME KUVVETİ kg	H2 TOPLAM YÜKSEKLİK mm	H1 YÜKLÜ TOPLAM YÜKSEKLİK mm	L YAY YOLU mm	YAYIN SON KUVVETİ kg
AD2407 MLR 100 M	100	28	64	79x70	60x50	8.5	90	8	155	140	15	18
AD2407 MLR 100 K	100	28	64	79x70	60x50	8.5	90	10	155	140	15	28
AD2407 MLR 100 S	100	28	64	79x70	60x50	8.5	90	25	155	140	15	40
AD2407 MLR 125 M	125	32	75	79x70	60x50	8.5	100	8	180	161	19	20
AD2407 MLR 125 K	125	32	75	79x70	60x50	8.5	100	12	180	161	19	30
AD2407 MLR 125 S	125	32	75	79x70	60x50	8.5	100	28	180	161	19	45



MTR		MOBLEN KASNAK ÜZERİ TERMOELASTİK KAPLAMA RULMANLI										
KOD NO	mm	mm	mm	mm	mm	mm	MAKSİMUM TAŞIMA KAPASİTESİ kg	ÖN GERME KUVVETİ kg	H2 TOPLAM YÜKSEKLİK mm	H1 YÜKLÜ TOPLAM YÜKSEKLİK mm	L YAY YOLU mm	YAYIN SON KUVVETİ kg
AD2407 MTR 100 M	100	32	64	79x70	60x50	8.5	100	8	155	140	15	18
AD2407 MTR 100 K	100	32	64	79x70	60x50	8.5	100	10	155	140	15	28
AD2407 MTR 100 S	100	32	64	79x70	60x50	8.5	100	25	155	140	15	40
AD2407 MTR 125 M	125	32	75	79x70	60x50	8.5	120	8	180	161	19	20
AD2407 MTR 125 K	125	32	75	79x70	60x50	8.5	120	12	180	161	19	30
AD2407 MTR 125 S	125	32	75	79x70	60x50	8.5	120	28	180	161	19	45



PUR		POLİAMİD KASNAK ÜZERİ POLİÜRETAN KAPLAMA RULMANLI										
KOD NO	mm	mm	mm	mm	mm	mm	MAKSİMUM TAŞIMA KAPASİTESİ kg	ÖN GERME KUVVETİ kg	H2 TOPLAM YÜKSEKLİK mm	H1 YÜKLÜ TOPLAM YÜKSEKLİK mm	L YAY YOLU mm	YAYIN SON KUVVETİ kg
AD2407 PUR 100 M	100	32	64	79x70	60x50	8.5	150	8	155	140	15	18
AD2407 PUR 100 K	100	32	64	79x70	60x50	8.5	150	10	155	140	15	28
AD2407 PUR 100 S	100	32	64	79x70	60x50	8.5	150	25	155	140	15	40
AD2407 PUR 125 M	125	32	75	79x70	60x50	8.5	180	8	180	161	19	20
AD2407 PUR 125 K	125	32	75	79x70	60x50	8.5	180	12	180	161	19	30
AD2407 PUR 125 S	125	32	75	79x70	60x50	8.5	180	28	180	161	19	45

- A:** BAĞLANTI CİVATASI
B: PLASTİK ALTİGEN BAŞLIK
C: ÜST MUHAFAZA KAPAĞI
D: TEK SIRA BİLYALI RULMAN
E: PLASTİK RULET MAŞASI

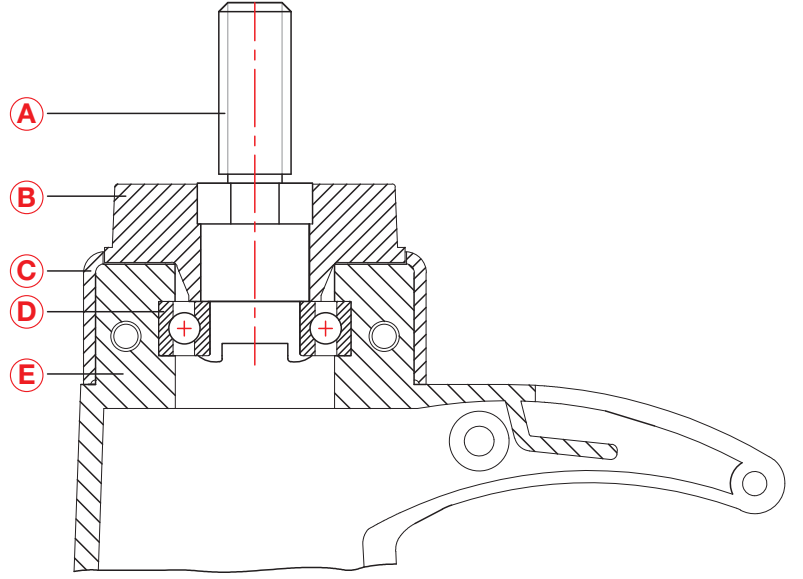







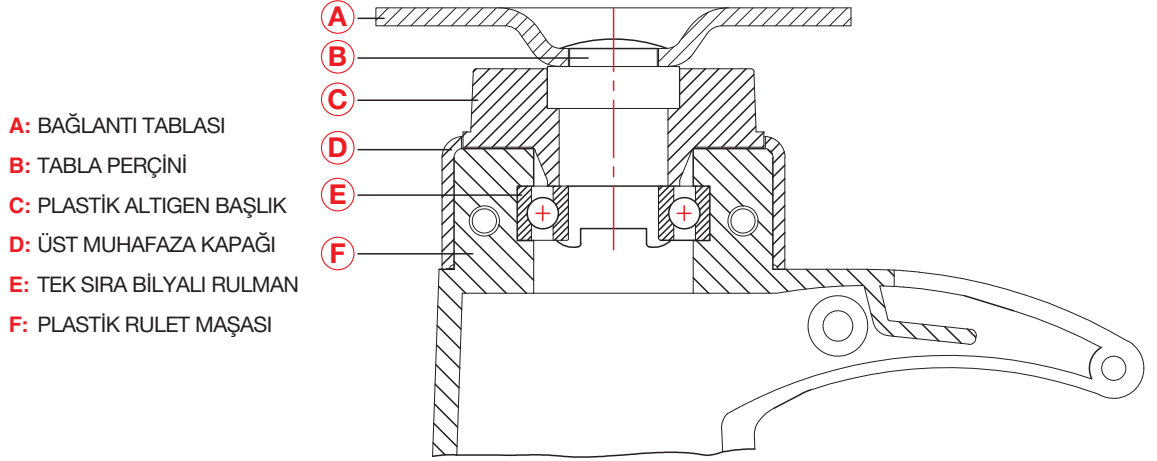

MTR		MOBLEN KASNAK ÜZERİ TERMOELASTİK KAPLAMA RULMANLI					
KOD NO	mm	mm	mm	mm	mm	mm	kg
2501 MTR 100	100	32	158	32.5	M12,16-5/8"	30	100
2501 MTR 125	125	32	183	32.5	M12,16-5/8"	30	110











MTR		MOBLEN KASNAK ÜZERİ TERMOELASTİK KAPLAMA RULMANLI					
KOD NO	mm	mm	mm	mm	mm	mm	kg
2501 MTR 100 F18	100	32	158	32.5	110	M12,16-5/8"	100
2501 MTR 125 F18	125	32	183	32.5	110	M12,16-5/8"	110









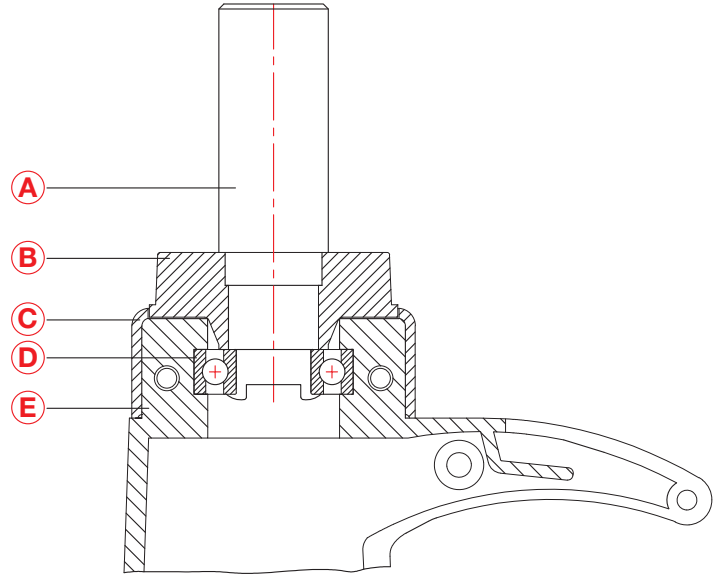

MTR		MOBLEN KASNAK ÜZERİ TERMOELASTİK KAPLAMA RULMANLI						
KOD NO								
	mm	mm	mm	mm	mm	mm	mm	kg
2502 MTR 100	100	32	168	32.5	79x70	60x50	9.5x8.5	100
2502 MTR 125	125	32	193	32.5	79x70	60x50	9.5x8.5	110











MTR		MOBLEN KASNAK ÜZERİ TERMOELASTİK KAPLAMA RULMANLI							
KOD NO									
	mm	mm	mm	mm	mm	mm	mm	kg	
2502 MTR 100 F18	100	32	168	32.5	110	79x70	60x50	9.5x8.5	100
2502 MTR 125 F18	125	32	193	32.5	110	79x70	60x50	9.5x8.5	110

- A:** BAĞLANTI PİMİ
- B:** PLASTİK ALTİGEN BAŞLIK
- C:** ÜST MUHAFAZA KAPAĞI
- D:** TEK SIRA BİLYALI RULMAN
- E:** PLASTİK RULET MAŞASI









MTR		MOBLEN KASNAK ÜZERİ TERMOELASTİK KAPLAMA RULMANLI					
KOD NO	 mm	 mm	 mm	 mm	 mm	 mm	 kg
2505 MTR 100	100	32	158	32.5	22	50	100
2505 MTR 125	125	32	183	32.5	22	50	110

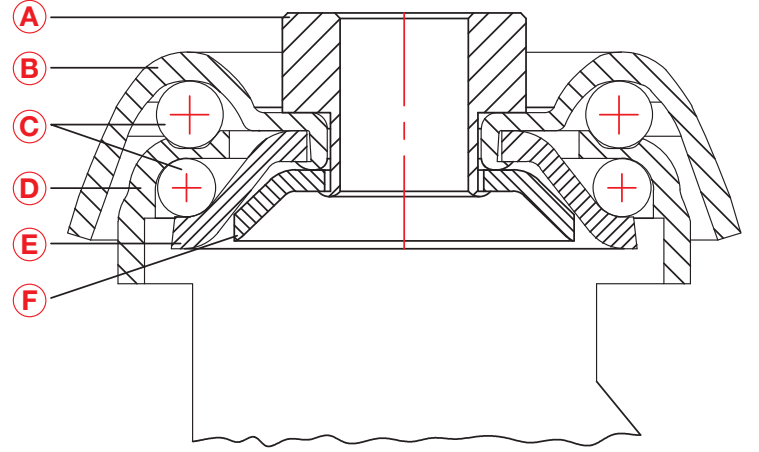







MTR		MOBLEN KASNAK ÜZERİ TERMOELASTİK KAPLAMA RULMANLI						
KOD NO	 mm	 mm	 mm	 mm	 mm	 mm	 mm	 kg
2505 MTR 100 F18	100	32	158	32.5	110	22	50	100
2505 MTR 125 F18	125	32	183	32.5	110	22	50	110

- A:** BORU PERÇİNİ
B: ÜST BİLYA KAPAĞI
C: KÜRESEL METAL TANE BİLYALAR
D: OYNAK RULET MAŞASI
E: ALT BİLYA ÇANAĞI
F: TERS ÇANAK







**MLR****MOBLEN KASNAK ÜZERİ KAUÇUK LASTİK KAPLAMA RULMANLI**

KOD NO	 mm	 mm	 mm	 mm	 mm	 kg
2600 MLR 100	100	28	130	34	12	100
2600 MLR 125	125	32	153	40	12	110

**MTR****MOBLEN KASNAK ÜZERİ TERMOELASTİK KAPLAMA RULMANLI**

KOD NO	 mm	 mm	 mm	 mm	 mm	 kg
2600 MTR 100	100	32	130	34	12	100
2600 MTR 125	125	32	153	40	12	110

**PUR****POLİAMİD KASNAK ÜZERİ POLİÜRETAN KAPLAMA RULMANLI**

KOD NO	 mm	 mm	 mm	 mm	 mm	 kg
2600 PUR 100	100	32	130	34	12	120
2600 PUR 125	125	32	153	40	12	130

- A:** PLASTİK ÜST BAŞLIK
- B:** ÜST BİLYA KAPAĞI
- C:** KÜRESEL METAL TANE BİLYALAR
- D:** CK60 MALZEMEDEN
SERTLEŞTİRİLMİŞ BİLYA YATAĞI
- E:** PLASTİK OYNAK MAŞA
- F:** ALT BİLYA ÇANAĞI
- G:** CK60 MALZEMEDEN
SERTLEŞTİRİLMİŞ FREN YAYI
- H:** PLASTİK FREN PEDALI

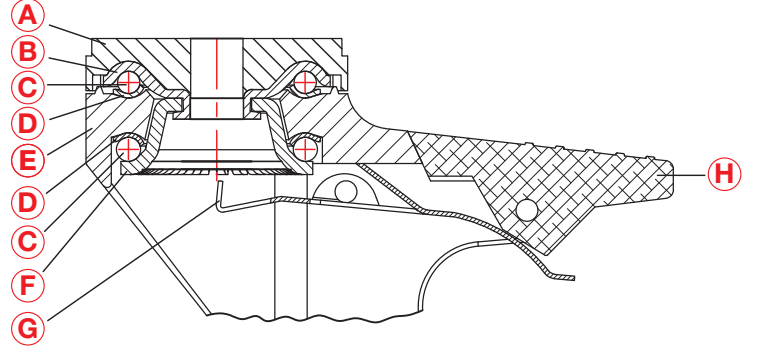

MTR		MOBLEN KASNAK ÜZERİ TERMOELASTİK KAPLAMA RULMANLI					
KOD NO	mm	mm	mm	mm	mm	kg	
P2800 MTR 100	100	32	145	42	12	100	
P2800 MTR 125	125	32	166	36	12	110	
P2800 MTR 150	150	32	193	30	12	130	



MTR		MOBLEN KASNAK ÜZERİ TERMOELASTİK KAPLAMA RULMANLI					
KOD NO	mm	mm	mm	mm	mm	mm	kg
P2800 MTR 100 F18	100	32	145	42	108	12	100
P2800 MTR 125 F18	125	32	166	36	107	12	110
P2800 MTR 150 F18	150	32	193	30	107	12	130

- A:** BAĞLANTI CİVATASI
- B:** PLASTİK ÜST KAPAK
- C:** ÜST BİLYA ÇANAĞI
- D:** KÜRESEL METAL TANE BİLYALAR
- E:** CK60 MALZEMEDEN
SERTLEŞTİRİLMİŞ BİLYA YATAĞI
- F:** PLASTİK OYNAK MAŞA
- G:** MONTAJ PULU
- H:** ALT BİLYA ÇANAĞI
- I:** CK60 MALZEMEDEN
SERTLEŞTİRİLMİŞ FREN YAYI
- J:** PLASTİK FREN PEDALI

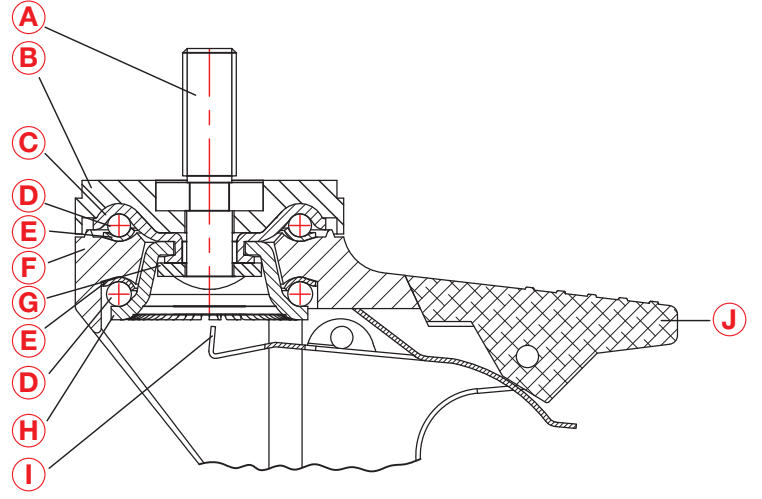

MTR		MOBLEN KASNAK ÜZERİ TERMOELASTİK KAPLAMA RULMANLI					
KOD NO	mm	mm	mm	mm	mm	mm	kg
P2801 MTR 100	100	32	145	42	M12,16-5/8"	30	100
P2801 MTR 125	125	32	166	36	M12,16-5/8"	30	110
P2801 MTR 150	150	32	193	30	M12,16-5/8"	30	130



MTR		MOBLEN KASNAK ÜZERİ TERMOELASTİK KAPLAMA RULMANLI						
KOD NO	mm	mm	mm	mm	mm	mm	kg	
P2801 MTR 100 F18	100	32	145	42	108	M12,16-5/8"	30	100
P2801 MTR 125 F18	125	32	166	36	107	M12,16-5/8"	30	110
P2801 MTR 150 F18	150	32	193	30	107	M12,16-5/8"	30	130

- A:** OYNAK BAĞLANTI TABLASI
- B:** TABLA PERÇİNİ
- C:** PLASTİK ÜST KAPAK
- D:** ÜST BİLYA KAPAĞI
- E:** KÜRESEL METAL TANE BİLYALAR
- F:** CK60 MALZEMEDEN
SERTLEŞTİRİLMİŞ BİLYA YATAĞI
- G:** PLASTİK OYNAK MAŞA
- H:** MONTAJ PULU
- I:** ALT BİLYA ÇANAĞI
- J:** CK60 MALZEMEDEN
SERTLEŞTİRİLMİŞ FREN YAYI
- K:** PLASTİK FREN PEDALI

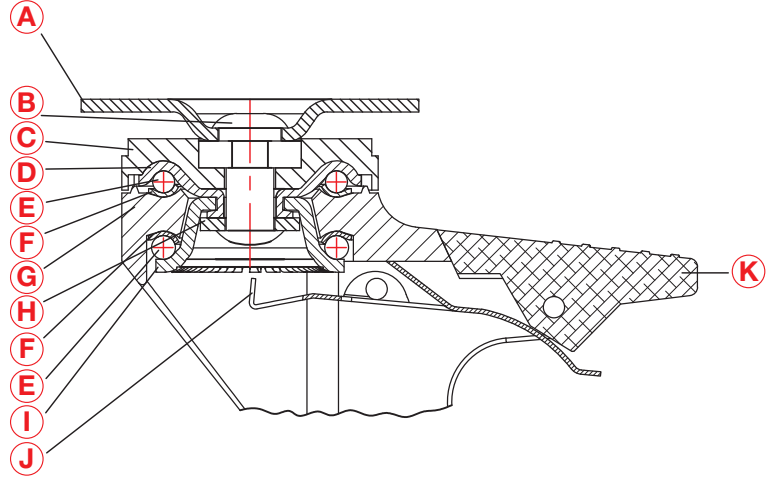

MTR

MOBLEN KASNAK ÜZERİ TERMOELASTİK KAPLAMA RULMANLI

KOD NO	mm	mm	mm	mm	mm	mm	mm	kg
P2802 MTR 100	100	32	155	42	79x70	60x50	9.5x8.5	100
P2802 MTR 125	125	32	176	36	79x70	60x50	9.5x8.5	110
P2802 MTR 150	150	32	202	30	79x70	60x50	9.5x8.5	130



MTR

MOBLEN KASNAK ÜZERİ TERMOELASTİK KAPLAMA RULMANLI

KOD NO	mm	mm	mm	mm	mm	mm	mm	kg	
P2802 MTR 100 F18	100	32	155	42	108	79x70	60x50	9.5x8.5	100
P2802 MTR 125 F18	125	32	176	36	107	79x70	60x50	9.5x8.5	110
P2802 MTR 150 F18	150	32	202	30	107	79x70	60x50	9.5x8.5	130

- A:** BAĞLANTI PİMİ
- B:** PLASTİK ÜST KAPAK
- C:** ÜST BİLYA ÇANAĞI
- D:** KÜRESEL METAL TANE BİLYALAR
- E:** CK60 MALZEMEDEN
SERTLEŞTİRİLMİŞ BİLYA YATAĞI
- F:** PLASTİK OYNAK MAŞA
- G:** MONTAJ PULU
- H:** ALT BİLYA ÇANAĞI
- I:** CK60 MALZEMEDEN
SERTLEŞTİRİLMİŞ FREN YAYI
- J:** PLASTİK FREN PEDALI

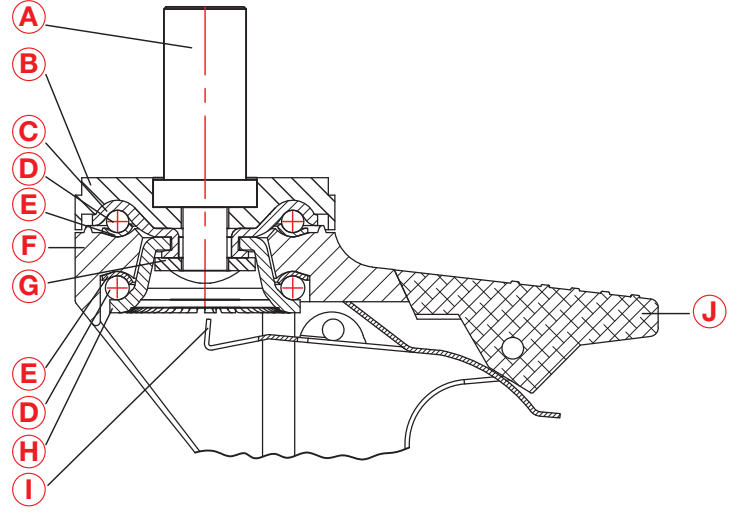

MTR		MOBLEN KASNAK ÜZERİ TERMOELASTİK KAPLAMA RULMANLI					
KOD NO	mm	mm	mm	mm	mm	mm	kg
P2805 MTR 100	100	32	145	42	22	50	100
P2805 MTR 125	125	32	166	36	22	50	110
P2805 MTR 150	150	32	193	30	22	50	130



MTR		MOBLEN KASNAK ÜZERİ TERMOELASTİK KAPLAMA RULMANLI					
KOD NO	mm	mm	mm	mm	mm	mm	kg
P2805 MTR 100 F18	100	32	145	42	108	22	100
P2805 MTR 125 F18	125	32	166	36	107	22	110
P2805 MTR 150 F18	150	32	193	30	107	22	130

- A:** IMBUS BAĞLANTI CIVATASI
- B:** KARE SOMUN
- C:** SOKET VE SOMUN ALTI
TAKVİYELİ PLASTİK
- D:** BAĞLANTI SOKETİ
- E:** PLASTİK ÜST KAPAK
- F:** ÜST BİLYA ÇANAĞI
- G:** KÜRESEL METAL TANE BİLYALAR
- H:** CK60 MALZEMEDEN
SERTLEŞTİRİLMİŞ BİLYA YATAĞI
- I:** PLASTİK OYNAK MAŞA
- J:** MONTAJ PULU
- K:** ALT BİLYA ÇANAĞI
- L:** CK60 MALZEMEDEN
SERTLEŞTİRİLMİŞ FREN YAYI
- M:** PLASTİK FREN PEDALI

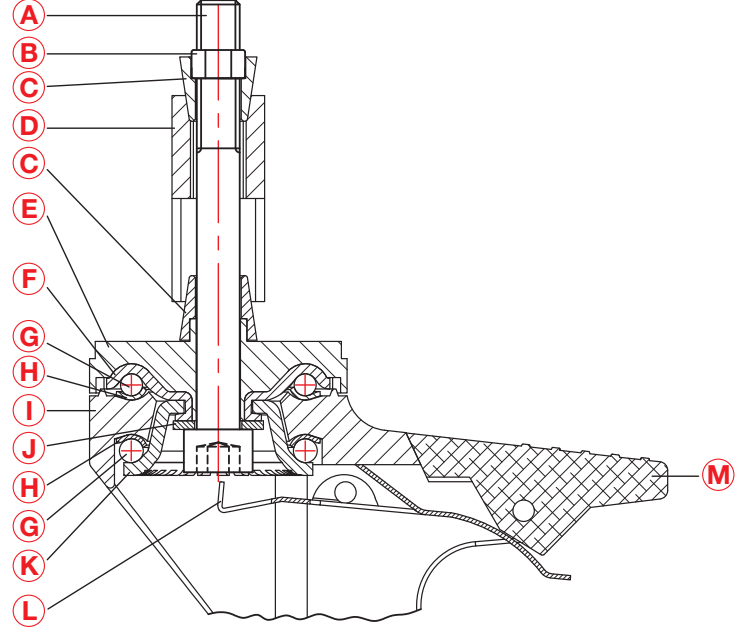







MTR		MOBLEN KASNAK ÜZERİ TERMOELASTİK KAPLAMA RULMANLI				
KOD NO	mm	mm	mm	mm	mm	kg
P2825 MTR 100	100	32	145	42	80	100
P2825 MTR 125	125	32	166	36	80	110
P2825 MTR 150	150	32	193	30	80	130

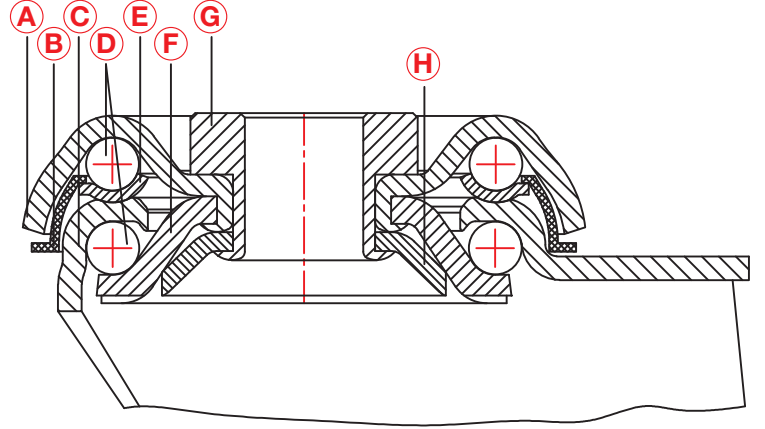







MTR		MOBLEN KASNAK ÜZERİ TERMOELASTİK KAPLAMA RULMANLI				
KOD NO	mm	mm	mm	mm	mm	kg
P2825 MTR 100 F18	100	32	145	42	108	100
P2825 MTR 125 F18	125	32	166	36	107	110
P2825 MTR 150 F18	150	32	193	30	107	130

- A:** ÜST BİLYA KAPAĞI
B: BİLYA MUHAFAZA TOZLUĞU
C: OYNAK RULET MAŞASI
D: KÜRESEL METAL TANE BİLYALAR
E: CK60 MALZEMEDEN
 SERTLEŞTİRİLMİŞ BİLYA YATAĞI
F: ALT BİLYA ÇANAĞI
G: BORU PERÇİNİ
H: TERS ÇANAK







**MLR****MOBLEN KASNAK ÜZERİ KAUÇUK LASTİK KAPLAMA RULMANLI**

KOD NO	 mm	 mm	 mm	 mm	 mm	 kg
2800 MLR 100	100	28	129	41	12	100
2800 MLR 125	125	32	156	40	12	110
2800 MLR 150	150	32	180	51	12	130

**MLR****MOBLEN KASNAK ÜZERİ KAUÇUK LASTİK KAPLAMA RULMANLI**

KOD NO	 mm	 mm	 mm	 mm	 mm	 mm	 kg
2800 MLR 100 F18	100	28	129	41	122	12	100
2800 MLR 125 F18	125	32	156	40	123	12	110
2800 MLR 150 F18	150	32	180	51	154	12	130

**MMB****MOBLEN TEKER BURÇLU**







KOD NO	 mm	 mm	 mm	 mm	 mm	 kg
2800 MMB 080	80	30	107	39	12	100
2800 MMB 100	100	30	129	41	12	110
2800 MMB 125	125	30	156	40	12	110

* 080 ve 100'LÜK RULETLERİMİZDE BEYAZ TEKER KULLANILMAKTADIR.









* 080 ve 100'LÜK RULETLERİMİZDE BEYAZ TEKER KULLANILMAKTADIR.







MMB
MOBLEN TEKER BURÇLU

KOD NO	 mm	 mm	 mm	 mm	 mm	 mm	 kg
2800 MMB 080 F18	80	30	107	39	122	12	100
2800 MMB 100 F18	100	30	129	41	122	12	130
2800 MMB 125 F18	125	30	156	40	123	12	120









MRR
MOBLEN KASNAK ÜZERİ KAÜÇUK LASTİK KAPLAMA RULMANLI

KOD NO	 mm	 mm	 mm	 mm	 mm	 mm	 kg
2800 MRR 100	100	28	129	41	12		100
2800 MRR 125	125	32	156	40	12		110









MRR
MOBLEN KASNAK ÜZERİ KAÜÇUK LASTİK KAPLAMA RULMANLI

KOD NO	 mm	 mm	 mm	 mm	 mm	 mm	 kg
2800 MRR 100 F18	100	28	129	41	122	12	100
2800 MRR 125 F18	125	32	156	40	123	12	110







MRR
MOBLEN KASNAK ÜZERİ KAÜÇUK LASTİK KAPLAMA RULMANLI

KOD NO	 mm	 mm	 mm	 mm	 mm	 mm	 kg
2800 MRR 150	150	32	180	51	12		130
2800 MRR 200	200	32	232	55	12		140







MRR
MOBLEN KASNAK ÜZERİ KAÜÇUK LASTİK KAPLAMA RULMANLI

KOD NO	 mm	 mm	 mm	 mm	 mm	 mm	 kg
2800 MRR 150 F18	150	32	180	51	154	12	130
2800 MRR 200 F18	200	32	232	55	154	12	140









MTB		MOBLEN KASNAK ÜZERİ TERMOELASTİK KAPLAMA BURÇLU					
KOD NO	 mm	 mm	 mm	 mm	 mm	 kg	
2800 MTB 080	80	32	107	39	12	90	
2800 MTB 100	100	32	129	41	12	100	
2800 MTB 125	125	32	156	40	12	110	
2800 MTB 150	150	32	180	51	12	130	
2800 MTB 200	200	32	232	55	12	140	









MTB		MOBLEN KASNAK ÜZERİ TERMOELASTİK KAPLAMA BURÇLU					
KOD NO	 mm	 mm	 mm	 mm	 mm	 mm	 kg
2800 MTB 080 F18	80	32	107	39	122	12	90
2800 MTB 100 F18	100	32	129	41	122	12	100
2800 MTB 125 F18	125	32	156	40	123	12	110
2800 MTB 150 F18	150	32	180	51	154	12	130
2800 MTB 200 F18	200	32	232	55	154	12	140









MTR		MOBLEN KASNAK ÜZERİ TERMOELASTİK KAPLAMA RULMANLI					
KOD NO	 mm	 mm	 mm	 mm	 mm	 kg	
2800 MTR 080	80	32	107	39	12	90	
2800 MTR 100	100	32	129	41	12	100	
2800 MTR 125	125	32	156	40	12	110	





MTR		MOBLEN KASNAK ÜZERİ TERMOELASTİK KAPLAMA RULMANLI					
KOD NO	 mm	 mm	 mm	 mm	 mm	 mm	 kg
2800 MTR 080 F18	80	32	107	39	122	12	90
2800 MTR 100 F18	100	32	129	41	122	12	100
2800 MTR 125 F18	125	32	156	40	123	12	110









MTR		MOBLEN KASNAK ÜZERİ TERMOELASTİK KAPLAMA RULMANLI					
KOD NO	 mm	 mm	 mm	 mm	 mm	 kg	
2800 MTR 150	150	32	180	51	12	130	
2800 MTR 200	200	32	232	55	12	140	









MTR		MOBLEN KASNAK ÜZERİ TERMOELASTİK KAPLAMA RULMANLI					
KOD NO	 mm	 mm	 mm	 mm	 mm	 mm	 kg
2800 MTR 150 F18	150	32	180	51	154	12	130
2800 MTR 200 F18	200	32	232	55	154	12	140









PPB		POLİAMİD TEKER BURÇLU					
KOD NO	 mm	 mm	 mm	 mm	 mm	 mm	 kg
2800 PPB 080	80	30	107	39	12		120
2800 PPB 100	100	30	129	41	12		130
2800 PPB 125	125	30	156	40	12		130







PPB		POLİAMİD TEKER BURÇLU					
KOD NO	 mm	 mm	 mm	 mm	 mm	 mm	 kg
2800 PPB 080 F18	80	30	107	39	122	12	120
2800 PPB 100 F18	100	30	129	41	122	12	130
2800 PPB 125 F18	125	30	156	40	123	12	130









PUB		POLİAMİD KASNAK ÜZERİ POLİÜRETAN KAPLAMA BURÇLU					
KOD NO	 mm	 mm	 mm	 mm	 mm	 mm	 kg
2800 PUB 080	80	32	107	39	12		110
2800 PUB 100	100	32	129	41	12		120
2800 PUB 125	125	32	156	40	12		130
2800 PUB 150	150	32	180	51	12		150
2800 PUB 200	200	32	232	55	12		150









PUB		POLİAMİD KASNAK ÜZERİ POLİÜRETAN KAPLAMA BURÇLU					
KOD NO	 mm	 mm	 mm	 mm	 mm	 mm	 kg
2800 PUB 080 F18	80	32	107	39	122	12	110
2800 PUB 100 F18	100	32	129	41	122	12	120
2800 PUB 125 F18	125	32	156	40	123	12	130
2800 PUB 150 F18	150	32	180	51	154	12	150
2800 PUB 200 F18	200	32	232	55	154	12	150







PUR		POLİAMİD KASNAK ÜZERİ POLİÜRETAN KAPLAMA RULMANLI					
KOD NO	 mm	 mm	 mm	 mm	 mm	 kg	
2800 PUR 080	80	32	107	39	12	110	
2800 PUR 100	100	32	129	41	12	120	
2800 PUR 125	125	32	156	40	12	130	









PUR		POLİAMİD KASNAK ÜZERİ POLİÜRETAN KAPLAMA RULMANLI					
KOD NO	 mm	 mm	 mm	 mm	 mm	 mm	 kg
2800 PUR 080 F18	80	32	107	39	122	12	110
2800 PUR 100 F18	100	32	129	41	122	12	120
2800 PUR 125 F18	125	32	156	40	123	12	130



PUR		POLİAMİD KASNAK ÜZERİ POLİÜRETAN KAPLAMA RULMANLI					
KOD NO	 mm	 mm	 mm	 mm	 mm	 kg	
2800 PUR 150	150	32	180	51	12	150	
2800 PUR 200	200	32	232	55	12	150	



PUR		POLİAMİD KASNAK ÜZERİ POLİÜRETAN KAPLAMA RULMANLI					
KOD NO	 mm	 mm	 mm	 mm	 mm	 mm	 kg
2800 PUR 150 F18	150	32	180	51	154	12	150
2800 PUR 200 F18	200	32	232	55	154	12	150







SES		GALVANİZ KAPLI SAC ÜZERİ GRİ KAUÇUK LASTİK KAPLAMA MASURALI					
KOD NO	 mm	 mm	 mm	 mm	 mm	 kg	
2800 SES 080	80	25	107	39	12	60	
2800 SES 100	100	30	129	41	12	80	
2800 SES 125	125	27	156	40	12	90	
2800 SES 150	150	27	180	51	12	100	



SES		GALVANİZ KAPLI SAC ÜZERİ GRİ KAUÇUK LASTİK KAPLAMA MASURALI					
KOD NO	 mm	 mm	 mm	 mm	 mm	 mm	 kg
2800 SES 080 F18	80	25	107	39	122	12	60
2800 SES 100 F18	100	30	129	41	122	12	80
2800 SES 125 F18	125	27	156	40	123	12	90
2800 SES 150 F18	150	27	180	51	154	12	100



UUR		RULMANLI, ENJEKSİYON POLİÜRETAN MARKET TEKERİ			
KOD NO	 mm	 mm	 mm	 mm	 kg
2800 UUR 125 F10	125	32	155	40	80

- A:** BAĞLANTI CİVATASI
- B:** ALTİGEN PUL
- C:** KISA BORU PERÇİNİ
- D:** ÜST BİLYA KAPAĞI
- E:** KÜRESEL METAL TANE BİLYALAR
- F:** CK60 MALZEMEDEN SERTLEŞTİRİLMİŞ BİLYA YATAĞI
- G:** BİLYA MUHAFAZA TOZLUĞU
- H:** OYNAK RULET MAŞASI
- I:** ALT BİLYA ÇANAĞI
- J:** MONTAJ PULU

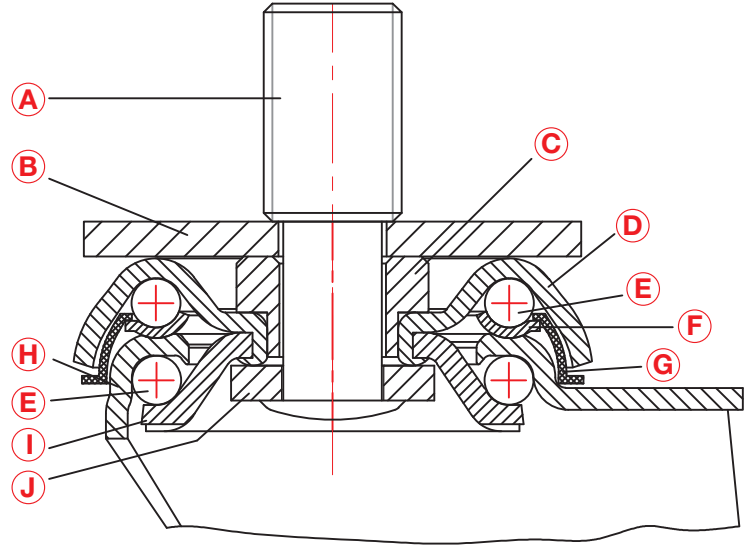

MLR		MOBLEN KASNAK ÜZERİ KAUÇUK LASTİK KAPLAMA RULMANLI					
KOD NO	mm	mm	mm	mm	mm	mm	kg
2801 MLR 100	100	28	133	41	M12,M16,5/8"	25	100
2801 MLR 125	125	32	160	40	M12,M16,5/8"	25	110



MLR		MOBLEN KASNAK ÜZERİ KAUÇUK LASTİK KAPLAMA RULMANLI					
KOD NO	mm	mm	mm	mm	mm	mm	kg
2801 MLR 100 F18	100	28	133	41	122	M12,M16,5/8"	25
2801 MLR 125 F18	125	32	160	40	123	M12,M16,5/8"	25











MMB		MOBLEN TEKER BURÇLU					
KOD NO	mm	mm	mm	mm	mm	mm	kg
2801 MMB 080	80	30	111	39	M12,M16,5/8"	25	100
2801 MMB 100	100	30	133	41	M12,M16,5/8"	25	110
2801 MMB 125	125	30	160	40	M12,M16,5/8"	25	110

* 080 ve 100'LÜK RULETLERİMİZDE BEYAZ TEKER KULLANILMAKTADIR.











* 080 ve 100'LÜK RULETLERİMİZDE BEYAZ TEKER KULLANILMAKTADIR.









MMB
MOBLEN TEKER BURÇLU

KOD NO	 mm	 mm	 mm	 mm	 mm	 mm	 mm	 kg
2801 MMB 080 F18	80	30	111	39	122	M12,M16,5/8"	25	100
2801 MMB 100 F18	100	30	133	41	122	M12,M16,5/8"	25	110
2801 MMB 125 F18	125	30	160	40	123	M12,M16,5/8"	25	110









MRR
MOBLEN KASNAK ÜZERİ KAÜÇUK LASTİK KAPLAMA RULMANLI

KOD NO	 mm	 mm	 mm	 mm	 mm	 mm	 mm	 kg
2801 MRR 100	100	28	133	41	122	M12,M16,5/8"	25	100
2801 MRR 125	125	32	160	40	123	M12,M16,5/8"	25	110









MRR
MOBLEN KASNAK ÜZERİ KAÜÇUK LASTİK KAPLAMA RULMANLI

KOD NO	 mm	 mm	 mm	 mm	 mm	 mm	 mm	 kg
2801 MRR 100 F18	100	28	133	41	122	M12,M16,5/8"	25	100
2801 MRR 125 F18	125	32	160	40	123	M12,M16,5/8"	25	110









MRR
MOBLEN KASNAK ÜZERİ KAÜÇUK LASTİK KAPLAMA RULMANLI

KOD NO	 mm	 mm	 mm	 mm	 mm	 mm	 mm	 kg
2801 MRR 150	150	32	184	51	122	M12,M16,5/8"	25	130
2801 MRR 200	200	32	236	55	123	M12,M16,5/8"	25	140









MRR
MOBLEN KASNAK ÜZERİ KAÜÇUK LASTİK KAPLAMA RULMANLI

KOD NO	 mm	 mm	 mm	 mm	 mm	 mm	 mm	 kg
2801 MRR 150 F18	150	32	184	51	154	M12,M16,5/8"	25	130
2801 MRR 200 F18	200	32	236	55	154	M12,M16,5/8"	25	140









MTB		MOBLEN KASNAK ÜZERİ TERMOELASTİK KAPLAMA BURÇLU						
KOD NO								
	mm	mm	mm	mm	mm	mm	kg	
2801 MTB 080	80	32	111	39	M12,M16,5/8"	25	90	
2801 MTB 100	100	32	133	41	M12,M16,5/8"	25	100	
2801 MTB 125	125	32	160	40	M12,M16,5/8"	25	110	
2801 MTB 150	150	32	184	51	M12,M16,5/8"	25	130	
2801 MTB 200	200	32	236	55	M12,M16,5/8"	25	140	









MTB		MOBLEN KASNAK ÜZERİ TERMOELASTİK KAPLAMA BURÇLU						
KOD NO								
	mm	mm	mm	mm	mm	mm	kg	
2801 MTB 080 F18	80	32	111	39	122	M12,M16,5/8"	25	90
2801 MTB 100 F18	100	32	133	41	122	M12,M16,5/8"	25	100
2801 MTB 125 F18	125	32	160	40	123	M12,M16,5/8"	25	110
2801 MTB 150 F18	150	32	184	51	154	M12,M16,5/8"	25	130
2801 MTB 200 F18	200	32	236	55	154	M12,M16,5/8"	25	140









MTR		MOBLEN KASNAK ÜZERİ TERMOELASTİK KAPLAMA RULMANLI						
KOD NO								
	mm	mm	mm	mm	mm	mm	kg	
2801 MTR 080	80	32	111	39	M12,M16,5/8"	25	90	
2801 MTR 100	100	32	133	41	M12,M16,5/8"	25	100	
2801 MTR 125	125	32	160	40	M12,M16,5/8"	25	110	











MTR		MOBLEN KASNAK ÜZERİ TERMOELASTİK KAPLAMA RULMANLI						
KOD NO								
	mm	mm	mm	mm	mm	mm	kg	
2801 MTR 080 F18	80	32	111	39	122	M12,M16,5/8"	25	90
2801 MTR 100 F18	100	32	133	41	122	M12,M16,5/8"	25	100
2801 MTR 125 F18	125	32	160	40	123	M12,M16,5/8"	25	110











MTR		MOBLEN KASNAK ÜZERİ TERMOELASTİK KAPLAMA RULMANLI						
KOD NO								
	mm	mm	mm	mm	mm	mm	kg	
2801 MTR 150	150	32	184	51	M12,M16,5/8"	25	130	
2801 MTR 200	200	32	236	55	M12,M16,5/8"	25	140	











MTR		MOBLEN KASNAK ÜZERİ TERMOELASTİK KAPLAMA RULMANLI						
KOD NO								
	mm	mm	mm	mm	mm	mm	mm	kg
2801 MTR 150 F18	150	32	184	51	154	M12,M16,5/8"	25	130
2801 MTR 200 F18	200	32	236	55	154	M12,M16,5/8"	25	140











PPB		POLİAMİD TEKER BURÇLU						
KOD NO								
	mm	mm	mm	mm	mm	mm	mm	kg
2801 PPB 080	80	30	111	39	M12,M16,5/8"	25	120	
2801 PPB 100	100	30	133	41	M12,M16,5/8"	25	130	
2801 PPB 125	125	30	160	40	M12,M16,5/8"	25	130	











PPB		POLİAMİD TEKER BURÇLU						
KOD NO								
	mm	mm	mm	mm	mm	mm	mm	kg
2801 PPB 080 F18	80	30	111	39	122	M12,M16,5/8"	25	120
2801 PPB 100 F18	100	30	133	41	122	M12,M16,5/8"	25	130
2801 PPB 125 F18	125	30	160	40	123	M12,M16,5/8"	25	130









PUB		POLİAMİD KASNAK ÜZERİ POLİÜRETAN KAPLAMA BURÇLU						
KOD NO								
	mm	mm	mm	mm	mm	mm	mm	kg
2801 PUB 080	80	32	111	39	M12,M16,5/8"	25	110	
2801 PUB 100	100	32	133	41	M12,M16,5/8"	25	120	
2801 PUB 125	125	32	160	40	M12,M16,5/8"	25	130	
2801 PUB 150	150	32	184	51	M12,M16,5/8"	25	150	
2801 PUB 200	200	32	236	55	M12,M16,5/8"	25	150	









PUB		POLİAMİD KASNAK ÜZERİ POLİÜRETAN KAPLAMA BURÇLU						
KOD NO								
	mm	mm	mm	mm	mm	mm	mm	kg
2801 PUB 080 F18	80	32	111	39	122	M12,M16,5/8"	25	110
2801 PUB 100 F18	100	32	133	41	122	M12,M16,5/8"	25	120
2801 PUB 125 F18	125	32	160	40	123	M12,M16,5/8"	25	130
2801 PUB 150 F18	150	32	184	51	154	M12,M16,5/8"	25	150
2801 PUB 200 F18	200	32	236	55	154	M12,M16,5/8"	25	150









PUR		POLİAMİD KASNAK ÜZERİ POLİÜRETAN KAPLAMA RULMANLI						
KOD NO	 mm	 mm	 mm	 mm	 mm	 mm	 kg	
2801 PUR 080	80	32	111	39	M12,M16,5/8"	25	110	
2801 PUR 100	100	32	133	41	M12,M16,5/8"	25	120	
2801 PUR 125	125	32	160	40	M12,M16,5/8"	25	130	









PUR		POLİAMİD KASNAK ÜZERİ POLİÜRETAN KAPLAMA RULMANLI						
KOD NO	 mm	 mm	 mm	 mm	 mm	 mm	 kg	
2801 PUR 080 F18	80	32	111	39	122	M12,M16,5/8"	25	110
2801 PUR 100 F18	100	32	133	41	122	M12,M16,5/8"	25	120
2801 PUR 125 F18	125	32	160	40	123	M12,M16,5/8"	25	130



PUR		POLİAMİD KASNAK ÜZERİ POLİÜRETAN KAPLAMA RULMANLI						
KOD NO	 mm	 mm	 mm	 mm	 mm	 mm	 kg	
2801 PUR 150	150	32	184	51	M12,M16,5/8"	25	150	
2801 PUR 200	200	32	236	55	M12,M16,5/8"	25	150	











PUR		POLİAMİD KASNAK ÜZERİ POLİÜRETAN KAPLAMA RULMANLI						
KOD NO	 mm	 mm	 mm	 mm	 mm	 mm	 kg	
2801 PUR 150 F18	150	32	184	51	154	M12,M16,5/8"	25	150
2801 PUR 200 F18	200	32	236	55	154	M12,M16,5/8"	25	150







SES		GALVANİZ KAPLI SAC ÜZERİ GRİ KAUÇUK LASTİK KAPLAMA MASURALI						
KOD NO	 mm	 mm	 mm	 mm	 mm	 mm	 kg	
2801 SES 080	80	25	111	39	M12,M16,5/8"	25	60	
2801 SES 100	100	30	133	41	M12,M16,5/8"	25	80	
2801 SES 125	125	27	160	40	M12,M16,5/8"	25	90	
2801 SES 150	150	27	184	51	M12,M16,5/8"	25	100	



SES
GALVANİZ KAPLI SAC ÜZERİ GRİ KAUÇUK LASTİK KAPLAMA MASURALI







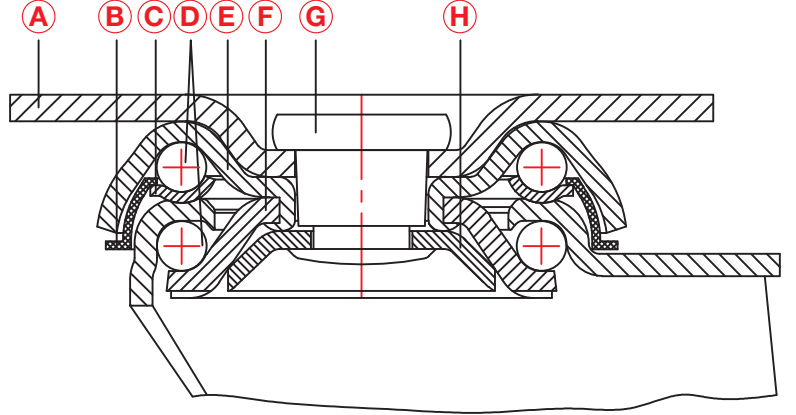

KOD NO	 mm	 mm	 mm	 mm	 mm	 mm	 mm	 kg
2801 SES 080 F18	80	25	111	39	122	M12,M16,5/8"	25	60
2801 SES 100 F18	100	30	133	41	122	M12,M16,5/8"	25	80
2801 SES 125 F18	125	27	160	40	123	M12,M16,5/8"	25	90
2801 SES 150 F18	150	27	184	51	154	M12,M16,5/8"	25	100

PUR
POLİAMİD KASNAK ÜZERİ POLİÜRETAN KAPLAMA RULMANLI









KOD NO	 mm	 mm	 mm	 mm	 kg
2801 PUR 125 F10	125	32	160	40	110

- A:** OYNAK BAĞLANTI TABLASI
B: BİLYA MUHAFAZA TOZLUĞU
C: CK60 MALZEMEDEN
 SERTLEŞTİRİLMİŞ BİLYA YATAĞI
D: KÜRESEL METAL TANE BİLYALAR
E: ÜST BİLYA KAPAĞI
F: ALT BİLYA ÇANAĞI
G: TABLA PERÇİNİ
H: TERS ÇANAK









**MLR****MOBLEN KASNAK ÜZERİ KAUÇUK LASTİK KAPLAMA RULMANLI**

KOD NO	 mm	 mm	 mm	 mm	 mm	 mm	 mm	 kg
2802 MLR 100	100	28	132	41	79x70	60x50	9.5x8.5	100
2802 MLR 125	125	32	159	40	79x70	60x50	9.5x8.5	110

**MLR****MOBLEN KASNAK ÜZERİ KAUÇUK LASTİK KAPLAMA RULMANLI**

KOD NO	 mm	 mm	 mm	 mm	 mm	 mm	 mm	 mm	 kg
2802 MLR 100 F18	100	28	132	41	122	79x70	60x50	9.5x8.5	100
2802 MLR 125 F18	125	32	159	40	123	79x70	60x50	9.5x8.5	110









**MMB****MOBLEN TEKER BURÇLU**

KOD NO	 mm	 mm	 mm	 mm	 mm	 mm	 mm	 kg
2802 MMB 080	80	30	110	39	79x70	60x50	9.5x8.5	100
2802 MMB 100	100	30	132	41	79x70	60x50	9.5x8.5	110
2802 MMB 125	125	30	159	40	79x70	60x50	9.5x8.5	110

* 080 ve 100'LÜK RULETLERİMİZDE BEYAZ TEKER KULLANILMAKTADIR.



* 080 ve 100'LÜK RULETLERİMİZDE BEYAZ TEKER KULLANILMAKTADIR.

MMB		MOBLEN TEKER BURÇLU							
KOD NO									
	mm	mm	mm	mm	mm	mm	mm	mm	kg
2802 MMB 080 F18	80	30	110	39	122	79x70	60x50	9.5x8.5	100
2802 MMB 100 F18	100	30	132	41	122	79x70	60x50	9.5x8.5	110
2802 MMB 125 F18	125	30	159	40	123	79x70	60x50	9.5x8.5	110



MRR		MOBLEN KASNAK ÜZERİ KAUKUK LASTİK KAPLAMA RULMANLI							
KOD NO									
	mm	mm	mm	mm	mm	mm	mm	mm	kg
2802 MRR 100	100	28	132	41	122	79x70	60x50	9.5x8.5	100
2802 MRR 125	125	32	159	40	123	79x70	60x50	9.5x8.5	110



MRR		MOBLEN KASNAK ÜZERİ KAUKUK LASTİK KAPLAMA RULMANLI							
KOD NO									
	mm	mm	mm	mm	mm	mm	mm	mm	kg
2802 MRR 100 F18	100	28	132	41	122	79x70	60x50	9.5x8.5	100
2802 MRR 125 F18	125	32	159	40	123	79x70	60x50	9.5x8.5	110











MRR		MOBLEN KASNAK ÜZERİ KAUKUK LASTİK KAPLAMA RULMANLI							
KOD NO									
	mm	mm	mm	mm	mm	mm	mm	mm	kg
2802 MRR 150	150	32	183	51	122	79x70	60x50	9.5x8.5	130
2802 MRR 200	200	32	235	55	123	79x70	60x50	9.5x8.5	140





MRR		MOBLEN KASNAK ÜZERİ KAUKUK LASTİK KAPLAMA RULMANLI							
KOD NO									
	mm	mm	mm	mm	mm	mm	mm	mm	kg
2802 MRR 150 F18	150	32	183	51	154	79x70	60x50	9.5x8.5	130
2802 MRR 200 F18	200	32	235	55	154	79x70	60x50	9.5x8.5	140











MTB		MOBLEN KASNAK ÜZERİ TERMOELASTİK KAPLAMA BURÇLU						
KOD NO								
	mm	mm	mm	mm	mm	mm	mm	kg
2802 MTB 080	80	32	110	39	79x70	60x50	9.5x8.5	90
2802 MTB 100	100	32	132	41	79x70	60x50	9.5x8.5	100
2802 MTB 125	125	32	159	40	79x70	60x50	9.5x8.5	110
2802 MTB 150	150	32	183	51	79x70	60x50	9.5x8.5	130
2802 MTB 200	200	32	235	55	79x70	60x50	9.5x8.5	140











MTB		MOBLEN KASNAK ÜZERİ TERMOELASTİK KAPLAMA BURÇLU							
KOD NO									
	mm	mm	mm	mm	mm	mm	mm	mm	kg
2802 MTB 080 F18	80	32	110	39	122	79x70	60x50	9.5x8.5	90
2802 MTB 100 F18	100	32	132	41	122	79x70	60x50	9.5x8.5	100
2802 MTB 125 F18	125	32	159	40	123	79x70	60x50	9.5x8.5	110
2802 MTB 150 F18	150	32	183	51	154	79x70	60x50	9.5x8.5	130
2802 MTB 200 F18	200	32	235	55	154	79x70	60x50	9.5x8.5	140











MTR		MOBLEN KASNAK ÜZERİ TERMOELASTİK KAPLAMA RULMANLI							
KOD NO									
	mm	mm	mm	mm	mm	mm	mm	mm	kg
2802 MTR 080	80	32	110	39		79x70	60x50	9.5x8.5	90
2802 MTR 100	100	32	132	41		79x70	60x50	9.5x8.5	100
2802 MTR 125	125	32	159	40		79x70	60x50	9.5x8.5	110



MTR		MOBLEN KASNAK ÜZERİ TERMOELASTİK KAPLAMA RULMANLI							
KOD NO									
	mm	mm	mm	mm	mm	mm	mm	mm	kg
2802 MTR 080 F18	80	32	110	39	122	79x70	60x50	9.5x8.5	90
2802 MTR 100 F18	100	32	132	41	122	79x70	60x50	9.5x8.5	100
2802 MTR 125 F18	125	32	159	40	123	79x70	60x50	9.5x8.5	110











MTR		MOBLEN KASNAK ÜZERİ TERMOELASTİK KAPLAMA RULMANLI							
KOD NO									
	mm	mm	mm	mm	mm	mm	mm	mm	kg
2802 MTR 150	150	32	183	51		79x70	60x50	9.5x8.5	130
2802 MTR 200	200	32	235	55		79x70	60x50	9.5x8.5	140











MTR		MOBLEN KASNAK ÜZERİ TERMOELASTİK KAPLAMA RULMANLI							
KOD NO									
	mm	mm	mm	mm	mm	mm	mm	mm	kg
2802 MTR 150 F18	150	32	183	51	154	79x70	60x50	9.5x8.5	130
2802 MTR 200 F18	200	32	235	55	154	79x70	60x50	9.5x8.5	140











PPB		POLİAMİD TEKER BURÇLU							
KOD NO									
	mm	mm	mm	mm	mm	mm	mm	mm	kg
2802 PPB 080	80	30	110	39	79x70	60x50	9.5x8.5	9.5x8.5	120
2802 PPB 100	100	30	132	41	79x70	60x50	9.5x8.5	9.5x8.5	130
2802 PPB 125	125	30	159	40	79x70	60x50	9.5x8.5	9.5x8.5	130











PPB		POLİAMİD TEKER BURÇLU							
KOD NO									
	mm	mm	mm	mm	mm	mm	mm	mm	kg
2802 PPB 080 F18	80	30	110	39	122	79x70	60x50	9.5x8.5	120
2802 PPB 100 F18	100	30	132	41	122	79x70	60x50	9.5x8.5	130
2802 PPB 125 F18	125	30	159	40	123	79x70	60x50	9.5x8.5	130











PUB		POLİAMİD KASNAK ÜZERİ POLİÜRETAN KAPLAMA BURÇLU							
KOD NO									
	mm	mm	mm	mm	mm	mm	mm	mm	kg
2802 PUB 080	80	32	110	39	79x70	60x50	9.5x8.5	9.5x8.5	110
2802 PUB 100	100	32	132	41	79x70	60x50	9.5x8.5	9.5x8.5	120
2802 PUB 125	125	32	159	40	79x70	60x50	9.5x8.5	9.5x8.5	130
2802 PUB 150	150	32	183	51	79x70	60x50	9.5x8.5	9.5x8.5	150
2802 PUB 200	200	32	235	55	79x70	60x50	9.5x8.5	9.5x8.5	150











PUB		POLİAMİD KASNAK ÜZERİ POLİÜRETAN KAPLAMA BURÇLU							
KOD NO									
	mm	mm	mm	mm	mm	mm	mm	mm	kg
2802 PUB 080 F18	80	32	110	39	122	79x70	60x50	9.5x8.5	110
2802 PUB 100 F18	100	32	132	41	122	79x70	60x50	9.5x8.5	120
2802 PUB 125 F18	125	32	159	40	123	79x70	60x50	9.5x8.5	130
2802 PUB 150 F18	150	32	183	51	154	79x70	60x50	9.5x8.5	150
2802 PUB 200 F18	200	32	235	55	154	79x70	60x50	9.5x8.5	150











PUR		POLİAMİD KASNAK ÜZERİ POLİÜRETAN KAPLAMA RULMANLI						
KOD NO								
	mm	mm	mm	mm	mm	mm	mm	kg
2802 PUR 080	80	32	110	39	79x70	60x50	9.5x8.5	110
2802 PUR 100	100	32	132	41	79x70	60x50	9.5x8.5	120
2802 PUR 125	125	32	159	40	79x70	60x50	9.5x8.5	130











PUR		POLİAMİD KASNAK ÜZERİ POLİÜRETAN KAPLAMA RULMANLI							
KOD NO									
	mm	mm	mm	mm	mm	mm	mm	kg	
2802 PUR 080 F18	80	32	110	39	122	79x70	60x50	9.5x8.5	110
2802 PUR 100 F18	100	32	132	41	122	79x70	60x50	9.5x8.5	120
2802 PUR 125 F18	125	32	159	40	123	79x70	60x50	9.5x8.5	130



PUR		POLİAMİD KASNAK ÜZERİ POLİÜRETAN KAPLAMA RULMANLI						
KOD NO								
	mm	mm	mm	mm	mm	mm	mm	kg
2802 PUR 150	150	32	183	51	79x70	60x50	9.5x8.5	150
2802 PUR 200	200	32	235	55	79x70	60x50	9.5x8.5	150













PUR		POLİAMİD KASNAK ÜZERİ POLİÜRETAN KAPLAMA RULMANLI							
KOD NO									
	mm	mm	mm	mm	mm	mm	mm	kg	
2802 PUR 150 F18	150	32	183	51	154	79x70	60x50	9.5x8.5	150
2802 PUR 200 F18	200	32	235	55	154	79x70	60x50	9.5x8.5	150



SES		GALVANİZ KAPLI SAC ÜZERİ GRİ KAUÇUK LASTİK KAPLAMA MASURALI						
KOD NO								
	mm	mm	mm	mm	mm	mm	mm	kg
2802 SES 080	80	25	110	39	79x70	60x50	9.5x8.5	60
2802 SES 100	100	30	132	41	79x70	60x50	9.5x8.5	80
2802 SES 125	125	27	159	40	79x70	60x50	9.5x8.5	90
2802 SES 150	150	27	183	51	79x70	60x50	9.5x8.5	100

SES
GALVANİZ KAPLI SAC ÜZERİ GRİ KAUÇUK LASTİK KAPLAMA MASURALI

KOD NO	 mm	 mm	 mm	 mm	 mm	 mm	 mm	 mm	 mm	 kg
2802 SES 080 F18	80	25	110	39	122	79x70	60x50	9.5x8.5	60	
2802 SES 100 F18	100	30	132	41	122	79x70	60x50	9.5x8.5	80	
2802 SES 125 F18	125	27	159	40	123	79x70	60x50	9.5x8.5	90	
2802 SES 150 F18	150	27	183	51	154	79x70	60x50	9.5x8.5	100	

- A:** BAĞLANTI PİMİ
- B:** ÜST BAŞLIK MONTAJ PULU
- C:** KÜRESEL METAL TANE BİLYALAR
- D:** ÜST BİLYA KAPAĞI
- E:** CK60 MALZEMEDEN SERTLEŞTİRİLMİŞ BİLYA YATAĞI
- F:** BİLYA MUHAFAZA TOZLUĞU
- G:** OYNAK RULET MAŞASI
- H:** ALT BİLYA ÇANAĞI
- I:** TERS ÇANAK

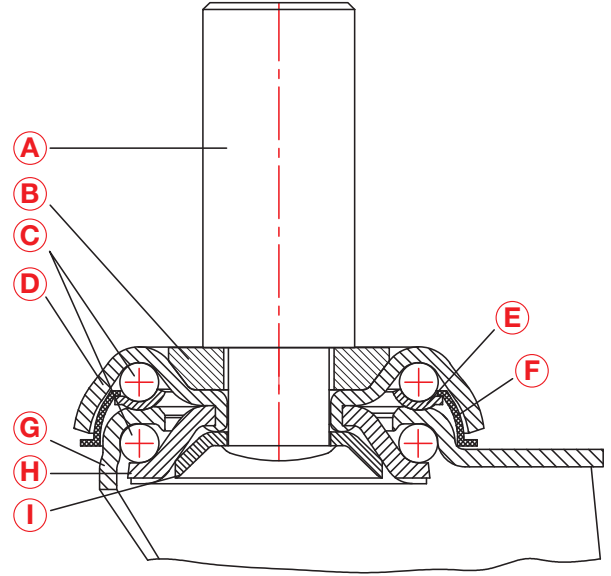

MLR		MOBLEN KASNAK ÜZERİ KAUÇUK LASTİK KAPLAMA RULMANLI					
KOD NO	mm	mm	mm	mm	mm	mm	kg
2805 MLR 100	100	28	129	41	22	50	100
2805 MLR 125	125	32	156	40	22	50	110



MLR		MOBLEN KASNAK ÜZERİ KAUÇUK LASTİK KAPLAMA RULMANLI						
KOD NO	mm	mm	mm	mm	mm	mm	kg	
2805 MLR 100 F18	100	28	129	41	122	22	50	100
2805 MLR 125 F18	125	32	156	40	123	22	50	110











MMB		MOBLEN TEKER BURÇLU					
KOD NO	mm	mm	mm	mm	mm	mm	kg
2805 MMB 080	80	30	107	39	22	50	100
2805 MMB 100	100	30	129	41	22	50	110
2805 MMB 125	125	30	156	40	22	50	110



* 080 ve 100'LÜK RULETLERİMİZDE BEYAZ TEKER KULLANILMAKTADIR.



* 080 ve 100'LÜK RULETLERİMİZDE BEYAZ TEKER KULLANILMAKTADIR.

MMB		MOBLEN TEKER BURÇLU						
KOD NO	 mm	 mm	 mm	 mm	 mm	 mm	 mm	 kg
2805 MMB 080 F18	80	30	107	39	122	22	50	100
2805 MMB 100 F18	100	30	129	41	122	22	50	110
2805 MMB 125 F18	125	30	156	40	123	22	50	110



MRR		MOBLEN KASNAK ÜZERİ KAUÇUK LASTİK KAPLAMA RULMANLI						
KOD NO	 mm	 mm	 mm	 mm	 mm	 mm	 mm	 kg
2805 MRR 100	100	28	129	41	22	50	100	
2805 MRR 125	125	32	156	40	22	50	110	



MRR		MOBLEN KASNAK ÜZERİ KAUÇUK LASTİK KAPLAMA RULMANLI						
KOD NO	 mm	 mm	 mm	 mm	 mm	 mm	 mm	 kg
2805 MRR 100 F18	100	28	129	41	122	22	50	100
2805 MRR 125 F18	125	32	156	40	123	22	50	110









MRR		MOBLEN KASNAK ÜZERİ KAUÇUK LASTİK KAPLAMA RULMANLI						
KOD NO	 mm	 mm	 mm	 mm	 mm	 mm	 mm	 kg
2805 MRR 150	150	32	180	51	22	50	130	
2805 MRR 200	200	32	232	55	22	50	140	











MRR		MOBLEN KASNAK ÜZERİ KAUÇUK LASTİK KAPLAMA RULMANLI						
KOD NO	 mm	 mm	 mm	 mm	 mm	 mm	 mm	 kg
2805 MRR 150 F18	150	32	180	51	154	22	50	130
2805 MRR 200 F18	200	32	232	55	154	22	50	140











MTB		MOBLEN KASNAK ÜZERİ TERMOELASTİK KAPLAMA BURÇLU						
KOD NO	 mm	 mm	 mm	 mm	 mm	 mm	 kg	
2805 MTB 080	80	32	107	39	22	50	90	
2805 MTB 100	100	32	129	41	22	50	100	
2805 MTB 125	125	32	156	40	22	50	110	
2805 MTB 150	150	32	180	51	22	50	130	
2805 MTB 200	200	32	232	55	22	50	140	











MTB		MOBLEN KASNAK ÜZERİ TERMOELASTİK KAPLAMA BURÇLU						
KOD NO	 mm	 mm	 mm	 mm	 mm	 mm	 mm	 kg
2805 MTB 080 F18	80	32	107	39	122	22	50	90
2805 MTB 100 F18	100	32	129	41	122	22	50	100
2805 MTB 125 F18	125	32	156	40	123	22	50	110
2805 MTB 150 F18	150	32	180	51	154	22	50	130
2805 MTB 200 F18	200	32	232	55	154	22	50	140











MTR		MOBLEN KASNAK ÜZERİ TERMOELASTİK KAPLAMA RULMANLI						
KOD NO	 mm	 mm	 mm	 mm	 mm	 mm	 mm	 kg
2805 MTR 080	80	32	107	39	22	50	90	
2805 MTR 100	100	32	129	41	22	50	100	
2805 MTR 125	125	32	156	40	22	50	110	









MTR		MOBLEN KASNAK ÜZERİ TERMOELASTİK KAPLAMA RULMANLI						
KOD NO	 mm	 mm	 mm	 mm	 mm	 mm	 mm	 kg
2805 MTR 080 F18	80	32	107	39	122	22	50	90
2805 MTR 100 F18	100	32	129	41	122	22	50	100
2805 MTR 125 F18	125	32	156	40	123	22	50	110











MTR		MOBLEN KASNAK ÜZERİ TERMOELASTİK KAPLAMA RULMANLI						
KOD NO	 mm	 mm	 mm	 mm	 mm	 mm	 mm	 kg
2805 MTR 150	150	32	180	51	22	50	130	
2805 MTR 200	200	32	232	55	22	50	140	











MTR		MOBLEN KASNAK ÜZERİ TERMOELASTİK KAPLAMA RULMANLI						
KOD NO	 mm	 mm	 mm	 mm	 mm	 mm	 mm	 kg
2805 MTR 150 F18	150	32	180	51	154	22	50	130
2805 MTR 200 F18	200	32	232	55	154	22	50	140











PPB		POLİAMİD TEKER BURÇLU						
KOD NO	 mm	 mm	 mm	 mm	 mm	 mm	 mm	 kg
2805 PPB 080	80	30	107	39	22	50	120	
2805 PPB 100	100	30	129	41	22	50	130	
2805 PPB 125	125	30	156	40	22	50	130	











PPB		POLİAMİD TEKER BURÇLU						
KOD NO	 mm	 mm	 mm	 mm	 mm	 mm	 mm	 kg
2805 PPB 080 F18	80	30	107	39	122	22	50	120
2805 PPB 100 F18	100	30	129	41	122	22	50	130
2805 PPB 125 F18	125	30	156	40	123	22	50	130









PUB		POLİAMİD KASNAK ÜZERİ POLİÜRETAN KAPLAMA BURÇLU						
KOD NO	 mm	 mm	 mm	 mm	 mm	 mm	 mm	 kg
2805 PUB 080	80	32	107	39	22	50	110	
2805 PUB 100	100	32	129	41	22	50	120	
2805 PUB 125	125	32	156	40	22	50	130	
2805 PUB 150	150	32	180	51	22	50	150	
2805 PUB 200	200	32	232	55	22	50	150	









PUB		POLİAMİD KASNAK ÜZERİ POLİÜRETAN KAPLAMA BURÇLU						
KOD NO	 mm	 mm	 mm	 mm	 mm	 mm	 mm	 kg
2805 PUB 080 F18	80	32	107	39	122	22	50	110
2805 PUB 100 F18	100	32	129	41	122	22	50	120
2805 PUB 125 F18	125	32	156	40	123	22	50	130
2805 PUB 150 F18	150	32	180	51	154	22	50	150
2805 PUB 200 F18	200	32	232	55	154	22	50	150









PUR		POLİAMİD KASNAK ÜZERİ POLİÜRETAN KAPLAMA RULMANLI						
KOD NO	 mm	 mm	 mm	 mm	 mm	 mm	 kg	
2805 PUR 080	80	32	107	39	22	50	110	
2805 PUR 100	100	32	129	41	22	50	120	
2805 PUR 125	125	32	156	40	22	50	130	









PUR		POLİAMİD KASNAK ÜZERİ POLİÜRETAN KAPLAMA RULMANLI						
KOD NO	 mm	 mm	 mm	 mm	 mm	 mm	 kg	
2805 PUR 080 F18	80	32	107	39	122	22	110	
2805 PUR 100 F18	100	32	129	41	122	22	120	
2805 PUR 125 F18	125	32	156	40	123	22	130	



PUR		POLİAMİD KASNAK ÜZERİ POLİÜRETAN KAPLAMA RULMANLI						
KOD NO	 mm	 mm	 mm	 mm	 mm	 mm	 kg	
2805 PUR 150	150	32	180	51	22	50	150	
2805 PUR 200	200	32	232	55	22	50	150	











PUR		POLİAMİD KASNAK ÜZERİ POLİÜRETAN KAPLAMA RULMANLI						
KOD NO	 mm	 mm	 mm	 mm	 mm	 mm	 kg	
2805 PUR 150 F18	150	32	180	51	154	22	150	
2805 PUR 200 F18	200	32	232	55	154	22	150	



SES		GALVANİZ KAPLI SAC ÜZERİ GRİ KAUÇUK LASTİK KAPLAMA MASURALI						
KOD NO	 mm	 mm	 mm	 mm	 mm	 mm	 kg	
2805 SES 080	80	25	107	39	22	50	60	
2805 SES 100	100	30	129	41	22	50	80	
2805 SES 125	125	27	156	40	22	50	90	
2805 SES 150	150	27	180	51	22	50	100	

SES
GALVANİZ KAPLI SAC ÜZERİ GRİ KAÇUK LASTİK KAPLAMA MASURALI

KOD NO	 mm	 mm	 mm	 mm	 mm	 mm	 mm	 kg
2805 SES 080 F18	80	25	107	39	122	22	50	60
2805 SES 100 F18	100	30	129	41	122	22	50	80
2805 SES 125 F18	125	27	156	40	123	22	50	90
2805 SES 150 F18	150	27	180	51	154	22	50	100

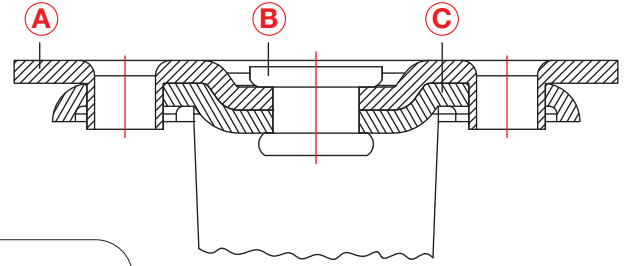

- A:** TABLA
B: TABLA PERÇİNİ
C: SABİT MAŞA

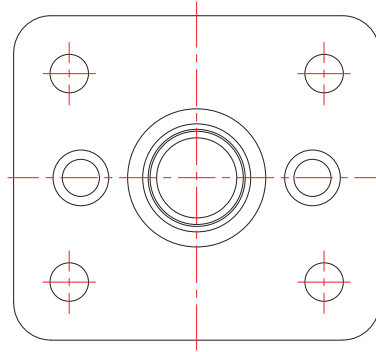

MLR		MOBLEN KASNAK ÜZERİ KAUÇUK LASTİK KAPLAMA RULMANLI						
KOD NO	mm	mm	mm	mm	mm	mm	kg	
2807 MLR 100	100	28	132	79x70	60x50	9.5x8.5	100	
2807 MLR 125	125	32	159	79x70	60x50	9.5x8.5	110	









MMB		MOBLEN TEKER BURÇLU						
KOD NO	mm	mm	mm	mm	mm	mm	kg	
2807 MMB 080	80	30	110	79x70	60x50	9.5x8.5	100	
2807 MMB 100	100	30	132	79x70	60x50	9.5x8.5	110	
2807 MMB 125	125	30	159	79x70	60x50	9.5x8.5	110	

* 080 ve 100'LÜK RULETLERİMİZDE BEYAZ TEKER KULLANILMAKTADIR.









MRR		MOBLEN KASNAK ÜZERİ KAUÇUK LASTİK KAPLAMA RULMANLI						
KOD NO	mm	mm	mm	mm	mm	mm	kg	
2807 MRR 100	100	28	132	79x70	60x50	9.5x8.5	100	
2807 MRR 125	125	32	159	79x70	60x50	9.5x8.5	110	









MRR
MOBLEN KASNAK ÜZERİ KAUÇUK LASTİK KAPLAMA RULMANLI

KOD NO	 mm	 mm	 mm	 mm	 mm	 mm	 kg
2807 MRR 150	150	32	184	79x70	60x50	9.5x8.5	130
2807 MRR 200	200	32	236	79x70	60x50	9.5x8.5	140









MTB
MOBLEN KASNAK ÜZERİ TERMOELASTİK KAPLAMA BURÇLU

KOD NO	 mm	 mm	 mm	 mm	 mm	 mm	 kg
2807 MTB 080	80	32	110	79x70	60x50	9.5x8.5	90
2807 MTB 100	100	32	132	79x70	60x50	9.5x8.5	100
2807 MTB 125	125	32	159	79x70	60x50	9.5x8.5	110
2807 MTB 150	150	32	183	79x70	60x50	9.5x8.5	130
2807 MTB 200	200	32	235	79x70	60x50	9.5x8.5	140









MTR
MOBLEN KASNAK ÜZERİ TERMOELASTİK KAPLAMA RULMANLI

KOD NO	 mm	 mm	 mm	 mm	 mm	 mm	 kg
2807 MTR 080	80	32	110	79x70	60x50	9.5x8.5	90
2807 MTR 100	100	32	132	79x70	60x50	9.5x8.5	100
2807 MTR 125	125	32	159	79x70	60x50	9.5x8.5	110









MTR
MOBLEN KASNAK ÜZERİ TERMOELASTİK KAPLAMA RULMANLI

KOD NO	 mm	 mm	 mm	 mm	 mm	 mm	 kg
2807 MTR 150	150	32	183	79x70	60x50	9.5x8.5	130
2807 MTR 200	200	32	235	79x70	60x50	9.5x8.5	140









PPB
POLİAMİD TEKER BURÇLU

KOD NO	 mm	 mm	 mm	 mm	 mm	 mm	 kg
2807 PPB 080	80	30	110	79x70	60x50	9.5x8.5	120
2807 PPB 100	100	30	132	79x70	60x50	9.5x8.5	130
2807 PPB 125	125	30	159	79x70	60x50	9.5x8.5	130









PUB		POLİAMİD KASNAK ÜZERİ POLİÜRETAN KAPLAMA BURÇLU						
KOD NO	 mm	 mm	 mm	 mm	 mm	 mm	 kg	
2807 PUB 080	80	32	110	79x70	60x50	9.5x8.5	110	
2807 PUB 100	100	32	132	79x70	60x50	9.5x8.5	120	
2807 PUB 125	125	32	159	79x70	60x50	9.5x8.5	130	
2807 PUB 150	150	32	183	79x70	60x50	9.5x8.5	150	
2807 PUB 200	200	32	235	79x70	60x50	9.5x8.5	150	



PUR		POLİAMİD KASNAK ÜZERİ POLİÜRETAN KAPLAMA RULMANLI						
KOD NO	 mm	 mm	 mm	 mm	 mm	 mm	 kg	
2807 PUR 080	80	32	110	79x70	60x50	9.5x8.5	110	
2807 PUR 100	100	32	132	79x70	60x50	9.5x8.5	120	
2807 PUR 125	125	32	159	79x70	60x50	9.5x8.5	130	



PUR		POLİAMİD KASNAK ÜZERİ POLİÜRETAN KAPLAMA RULMANLI						
KOD NO	 mm	 mm	 mm	 mm	 mm	 mm	 kg	
2807 PUR 150	150	32	183	79x70	60x50	9.5x8.5	150	
2807 PUR 200	200	32	235	79x70	60x50	9.5x8.5	150	



SES		GALVANİZ KAPLI SAC ÜZERİ GRİ KAÇUK LASTİK KAPLAMA MASURALI						
KOD NO	 mm	 mm	 mm	 mm	 mm	 mm	 kg	
2807 SES 080	80	25	110	79x70	60x50	9.5x8.5	60	
2807 SES 100	100	30	132	79x70	60x50	9.5x8.5	80	
2807 SES 125	125	27	159	79x70	60x50	9.5x8.5	90	
2807 SES 150	150	27	183	79x70	60x50	9.5x8.5	100	

- A:** IMBUS BAĞLANTI CİVATASI
- B:** KARE SOMUN
- C:** SOKET VE SOMUN ALTI TAKVİYELİ PLASTİK
- D:** BAĞLANTI SOKETİ
- E:** BORU PERÇİNİ
- F:** ÜST BİLYA KAPAĞI
- G:** KÜRESEL METAL TANE BİLYALAR
- H:** CK60 MALZEMEDEN SERTLEŞTİRİLMİŞ BİLYA YATAĞI
- I:** BİLYA MUHAFAZA TOZLUĞU
- J:** OYNAK RULET MAŞASI
- K:** ALT BİLYA ÇANAĞI
- L:** TERS ÇANAK
- M:** MONTAJ PULU

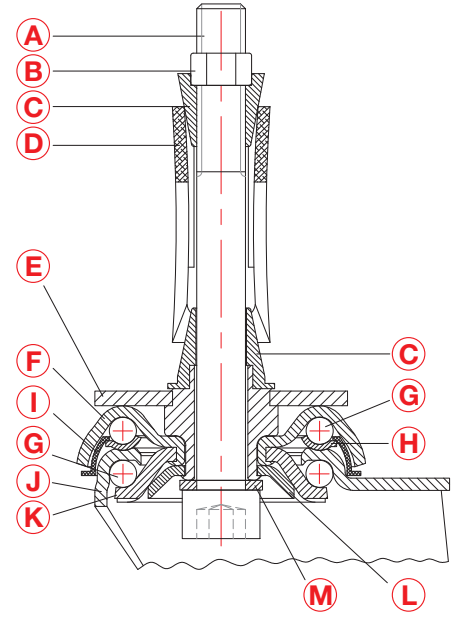

MLR		MOBLEN KASNAK ÜZERİ KAUCUK LASTİK KAPLAMA RULMANLI				
KOD NO	mm	mm	mm	mm	mm	kg
2825 MLR 100	100	28	132	41	80	100
2825 MLR 125	125	32	159	40	80	110



MLR		MOBLEN KASNAK ÜZERİ KAUCUK LASTİK KAPLAMA RULMANLI				
KOD NO	mm	mm	mm	mm	mm	kg
2825 MLR 100 F18	100	28	132	41	122	100
2825 MLR 125 F18	125	32	159	40	123	110









MMB		MOBLEN TEKER BURÇLU				
KOD NO	mm	mm	mm	mm	mm	kg
2825 MMB 080	80	30	110	39	80	100
2825 MMB 100	100	30	132	41	80	110
2825 MMB 125	125	30	159	40	80	110

* 080 ve 100'LÜK RULETLERİMİZDE BEYAZ TEKER KULLANILMAKTADIR.



* 080 ve 100'LÜK RULETLERİMİZDE BEYAZ TEKER KULLANILMAKTADIR.

MMB		MOBLEN TEKER BURÇLU					
KOD NO	 mm	 mm	 mm	 mm	 mm	 mm	 kg
2825 MMB 080 F18	80	30	110	39	122	80	100
2825 MMB 100 F18	100	30	132	41	122	80	110
2825 MMB 125 F18	125	30	159	40	123	80	110



MRR		MOBLEN KASNAK ÜZERİ KAUÇUK LASTİK KAPLAMA RULMANLI					
KOD NO	 mm	 mm	 mm	 mm	 mm	 mm	 kg
2825 MRR 100	100	28	132	41	80	80	100
2825 MRR 125	125	32	159	40	80	80	110



MRR		MOBLEN KASNAK ÜZERİ KAUÇUK LASTİK KAPLAMA RULMANLI					
KOD NO	 mm	 mm	 mm	 mm	 mm	 mm	 kg
2825 MRR 100 F18	100	28	132	41	122	80	100
2825 MRR 125 F18	125	32	159	40	123	80	110









MRR		MOBLEN KASNAK ÜZERİ KAUÇUK LASTİK KAPLAMA RULMANLI					
KOD NO	 mm	 mm	 mm	 mm	 mm	 mm	 kg
2825 MRR 150	150	32	184	51	80	80	130
2825 MRR 200	200	32	236	55	80	80	140









MRR		MOBLEN KASNAK ÜZERİ KAUÇUK LASTİK KAPLAMA RULMANLI					
KOD NO	 mm	 mm	 mm	 mm	 mm	 mm	 kg
2825 MRR 150 F18	150	32	184	51	154	80	130
2825 MRR 200 F18	200	32	236	55	154	80	140









MTB		MOBLEN KASNAK ÜZERİ TERMOELASTİK KAPLAMA BURÇLU				
KOD NO	 mm	 mm	 mm	 mm	 mm	 kg
2825 MTB 080	80	32	110	39	80	90
2825 MTB 100	100	32	132	41	80	100
2825 MTB 125	125	32	159	40	80	110
2825 MTB 150	150	32	184	51	80	130
2825 MTB 200	200	32	236	55	80	140









MTB		MOBLEN KASNAK ÜZERİ TERMOELASTİK KAPLAMA BURÇLU				
KOD NO	 mm	 mm	 mm	 mm	 mm	 kg
2825 MTB 080 F18	80	32	110	39	122	90
2825 MTB 100 F18	100	32	132	41	122	100
2825 MTB 125 F18	125	32	159	40	123	110
2825 MTB 150 F18	150	32	184	51	154	130
2825 MTB 200 F18	200	32	236	55	154	140









MTR		MOBLEN KASNAK ÜZERİ TERMOELASTİK KAPLAMA RULMANLI				
KOD NO	 mm	 mm	 mm	 mm	 mm	 kg
2825 MTR 080	80	32	110	39	80	90
2825 MTR 100	100	32	132	41	80	100
2825 MTR 125	125	32	159	40	80	110









MTR		MOBLEN KASNAK ÜZERİ TERMOELASTİK KAPLAMA RULMANLI				
KOD NO	 mm	 mm	 mm	 mm	 mm	 kg
2825 MTR 080 F18	80	32	110	39	122	90
2825 MTR 100 F18	100	32	132	41	122	100
2825 MTR 125 F18	125	32	159	40	123	110









MTR		MOBLEN KASNAK ÜZERİ TERMOELASTİK KAPLAMA RULMANLI				
KOD NO	 mm	 mm	 mm	 mm	 mm	 kg
2825 MTR 150	150	32	184	51	80	130
2825 MTR 200	200	32	236	55	80	140









MTR		MOBLEN KASNAK ÜZERİ TERMOELASTİK KAPLAMA RULMANLI					
KOD NO	 mm	 mm	 mm	 mm	 mm	 mm	 kg
2825 MTR 150 F18	150	32	184	51	154	80	130
2825 MTR 200 F18	200	32	236	55	154	80	140









PPB		POLİAMİD TEKER BURÇLU				
KOD NO	 mm	 mm	 mm	 mm	 mm	 kg
2825 PPB 080	80	30	110	39	80	120
2825 PPB 100	100	30	132	41	80	130
2825 PPB 125	125	30	159	40	80	130









PPB		POLİAMİD TEKER BURÇLU					
KOD NO	 mm	 mm	 mm	 mm	 mm	 kg	
2825 PPB 080 F18	80	30	110	39	122	80	120
2825 PPB 100 F18	100	30	132	41	122	80	130
2825 PPB 125 F18	125	30	159	40	123	80	130









PUB		POLİAMİD KASNAK ÜZERİ POLİÜRETAN KAPLAMA BURÇLU				
KOD NO	 mm	 mm	 mm	 mm	 mm	 kg
2825 PUB 080	80	32	110	39	80	110
2825 PUB 100	100	32	132	41	80	120
2825 PUB 125	125	32	159	40	80	130
2825 PUB 150	150	32	184	51	80	150
2825 PUB 200	200	32	236	55	80	150









PUB		POLİAMİD KASNAK ÜZERİ POLİÜRETAN KAPLAMA BURÇLU				
KOD NO	 mm	 mm	 mm	 mm	 mm	 kg
2825 PUB 080 F18	80	32	110	39	122	110
2825 PUB 100 F18	100	32	132	41	122	120
2825 PUB 125 F18	125	32	159	40	123	130
2825 PUB 150 F18	150	32	184	51	154	150
2825 PUB 200 F18	200	32	236	55	154	150









PUR		POLİAMİD KASNAK ÜZERİ POLİÜRETAN KAPLAMA RULMANLI					
KOD NO	 mm	 mm	 mm	 mm	 mm	 kg	
2825 PUR 080	80	32	110	39	80	110	
2825 PUR 100	100	32	132	41	80	120	
2825 PUR 125	125	32	159	40	80	130	









PUR		POLİAMİD KASNAK ÜZERİ POLİÜRETAN KAPLAMA RULMANLI					
KOD NO	 mm	 mm	 mm	 mm	 mm	 mm	 kg
2825 PUR 080 F18	80	32	110	39	122	80	110
2825 PUR 100 F18	100	32	132	41	122	80	120
2825 PUR 125 F18	125	32	159	40	123	80	130



PUR		POLİAMİD KASNAK ÜZERİ POLİÜRETAN KAPLAMA RULMANLI					
KOD NO	 mm	 mm	 mm	 mm	 mm	 kg	
2825 PUR 150	150	32	184	51	80	150	
2825 PUR 200	200	32	236	55	80	150	



PUR		POLİAMİD KASNAK ÜZERİ POLİÜRETAN KAPLAMA RULMANLI					
KOD NO	 mm	 mm	 mm	 mm	 mm	 mm	 kg
2825 PUR 150 F18	150	32	184	51	154	80	150
2825 PUR 200 F18	200	32	236	55	154	80	150



SES		GALVANİZ KAPLI SAC ÜZERİ GRİ KAUÇUK LASTİK KAPLAMA MASURALI					
KOD NO	 mm	 mm	 mm	 mm	 mm	 kg	
2825 SES 080	80	25	110	34	80	60	
2825 SES 100	100	30	132	41	80	80	
2825 SES 125	125	27	159	40	80	90	
2825 SES 150	150	27	184	51	80	100	





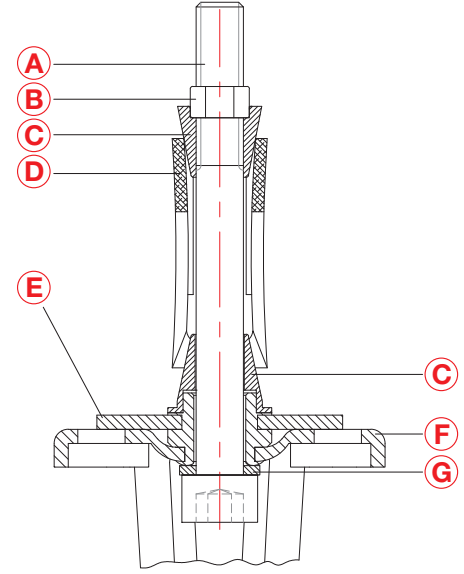

SES		GALVANİZ KAPLI SAC ÜZERİ GRİ KAUÇUK LASTİK KAPLAMA MASURALI					
KOD NO	 mm	 mm	 mm	 mm	 mm	 mm	 kg
2825 SES 080 F18	80	25	110	34	122	80	60
2825 SES 100 F18	100	30	132	41	122	80	80
2825 SES 125 F18	125	27	159	40	123	80	90
2825 SES 150 F18	150	27	184	51	154	80	100

- A:** IMBUS BAĞLANTI CİVATASI
- B:** KARE SOMUN
- C:** SOKET VE SOMUN ALTI TAKVİYELİ PLASTİK
- D:** BAĞLANTI SOKETİ
- E:** BORU PERÇİNİ
- F:** SABİT RULET MAŞASI
- G:** MONTAJ RONDELASI



MLR		MOBLEN KASNAK ÜZERİ KAUÇUK LASTİK KAPLAMA RULMANLI			
KOD NO	 mm	 mm	 mm	 mm	 kg
2827 MLR 100	100	28	132	80	100
2827 MLR 125	125	32	159	80	110



MMB		MOBLEN TEKER BURÇLU			
KOD NO	 mm	 mm	 mm	 mm	 kg
2827 MMB 080	80	30	110	80	100
2827 MMB 100	100	30	132	80	110
2827 MMB 125	125	30	159	80	110

* 080 ve 100'LÜK RULETLERİMİZDE BEYAZ TEKER KULLANILMAKTADIR.







MRR		MOBLEN KASNAK ÜZERİ KAUÇUK LASTİK KAPLAMA RULMANLI			
KOD NO	 mm	 mm	 mm	 mm	 kg
2827 MRR 100	100	28	132	80	100
2827 MRR 125	125	32	159	80	110







MRR		MOBLEN KASNAK ÜZERİ KAUÇUK LASTİK KAPLAMA RULMANLI				
KOD NO	 mm	 mm	 mm	 mm	 kg	
2827 MRR 150	150	32	184	80	130	
2827 MRR 200	200	32	236	80	140	







MTB		MOBLEN KASNAK ÜZERİ TERMOELASTİK KAPLAMA BURÇLU				
KOD NO	 mm	 mm	 mm	 mm	 kg	
2827 MTB 080	80	32	110	80	90	
2827 MTB 100	100	32	132	80	100	
2827 MTB 125	125	32	159	80	110	
2827 MTB 150	150	32	184	80	130	
2827 MTB 200	200	32	236	80	140	







MTR		MOBLEN KASNAK ÜZERİ TERMOELASTİK KAPLAMA RULMANLI				
KOD NO	 mm	 mm	 mm	 mm	 kg	
2827 MTR 080	80	32	110	80	90	
2827 MTR 100	100	32	132	80	100	
2827 MTR 125	125	32	159	80	110	







MTR		MOBLEN KASNAK ÜZERİ TERMOELASTİK KAPLAMA RULMANLI				
KOD NO	 mm	 mm	 mm	 mm	 kg	
2827 MTR 150	150	32	184	80	130	
2827 MTR 200	200	32	236	80	140	







PPB		POLİAMİD TEKER BURÇLU				
KOD NO	 mm	 mm	 mm	 mm	 kg	
2827 PPB 080	80	30	110	80	120	
2827 PPB 100	100	30	132	80	130	
2827 PPB 125	125	30	159	80	130	







PUB		POLİAMİD KASNAK ÜZERİ POLİÜRETAN KAPLAMA BURÇLU				
KOD NO	 mm	 mm	 mm	 mm	 kg	
2827 PUB 080	80	32	110	80	110	
2827 PUB 100	100	32	132	80	120	
2827 PUB 125	125	32	159	80	130	
2827 PUB 150	150	32	184	80	150	
2827 PUB 200	200	32	236	80	150	



PUR		POLİAMİD KASNAK ÜZERİ POLİÜRETAN KAPLAMA RULMANLI				
KOD NO	 mm	 mm	 mm	 mm	 kg	
2827 PUR 080	80	32	110	80	110	
2827 PUR 100	100	32	132	80	120	
2827 PUR 125	125	32	159	80	130	





PUR		POLİAMİD KASNAK ÜZERİ POLİÜRETAN KAPLAMA RULMANLI				
KOD NO	 mm	 mm	 mm	 mm	 kg	
2827 PUR 150	150	32	184	80	150	
2827 PUR 200	200	32	236	80	150	





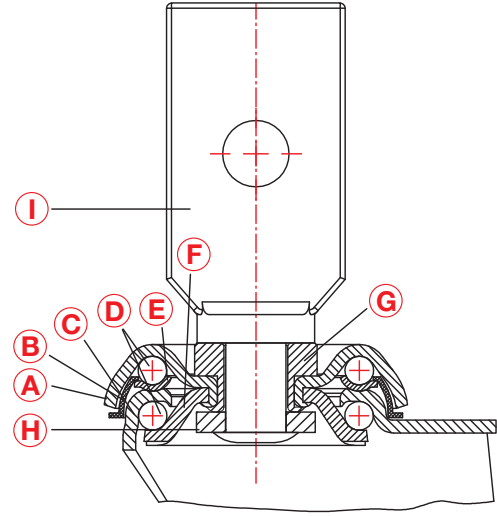

SES		GALVANİZ KAPLI SAC ÜZERİ GRİ KAUÇUK LASTİK KAPLAMA MASURALI				
KOD NO	 mm	 mm	 mm	 mm	 kg	
2827 SES 080	80	25	110	80	60	
2827 SES 100	100	30	132	80	80	
2827 SES 125	125	27	159	80	90	
2827 SES 150	150	27	184	80	100	

- A:** ÜST BİLYE KAPAĞI
- B:** BİLYE MUHAFAZA TOZLUĞU
- C:** OYNAK RULET MAŞASI
- D:** KÜRESEL METAL TANE BİLYELER
- E:** CK60 MALZEMEDEN SERTLEŞTİRİLMİŞ BİLYE KAPAĞI
- F:** ALT BİLYE ÇANAĞI
- G:** BORU PERÇİNİ
- H:** PUL
- I:** LAMA



PUR		POLİAMİD KASNAK ÜZERİ POLİÜRETAN KAPLAMA RULMANLI			
KOD NO	 mm	 mm	 mm	 mm	 kg
2818 PUR 125 F10	125	32	155	40	110



PUR		POLİAMİD KASNAK ÜZERİ POLİÜRETAN KAPLAMA RULMANLI			
KOD NO	 mm	 mm	 mm	 mm	 kg
2818 PUR 125 F16	125	32	155	40	110

- A:** BAĞLANTI TABLASI
- B:** TABLA PERÇİNİ
- C:** OYNAK RULET MAŞASI
- D:** BİLYA MUHAFAZA TOZLUĞU
- E:** CK60 MALZEMEDEN
SERTLEŞTİRİLMİŞ BİLYA YATAĞI
- F:** KÜRESEL METAL TANE BİLYALAR
- G:** ALT BİLYA ÇANAĞI
- H:** MONTAJ PULU

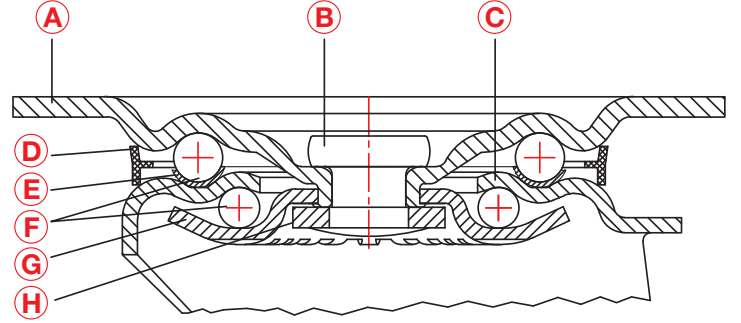

CTB		GÜÇLENDİRİLMİŞ POLIAMİD KASNAK ÜZERİ TERMOELASTİK GRİ LASTİK KAPLAMA BURÇLU						
KOD NO								
	mm	mm	mm	mm	mm	mm	mm	kg
3202 CTB 100	100	35	135	48	140x110	105x80	13.5x11	120
3202 CTB 125	125	40	161	49.5	140x110	105x80	13.5x11	150
3202 CTB 150	150	45	184	55	140x110	105x80	13.5x11	180



CTB		GÜÇLENDİRİLMİŞ POLIAMİD KASNAK ÜZERİ TERMOELASTİK GRİ LASTİK KAPLAMA BURÇLU							
KOD NO									
	mm	mm	mm	mm	mm	mm	mm	kg	
3202 CTB 100 F18	100	35	135	48	156	140x110	105x80	13.5x11	120
3202 CTB 125 F18	125	40	161	49.5	156	140x110	105x80	13.5x11	150
3202 CTB 150 F18	150	45	184	55	156	140x110	105x80	13.5x11	180



CTR		GÜÇLENDİRİLMİŞ POLIAMİD KASNAK ÜZERİ TERMOELASTİK GRİ LASTİK KAPLAMA RULMANLI						
KOD NO								
	mm	mm	mm	mm	mm	mm	mm	kg
3202 CTR 100	100	35	135	48	140x110	105x80	13.5x11	120
3202 CTR 125	125	40	161	49.5	140x110	105x80	13.5x11	150
3202 CTR 150	150	45	184	55	140x110	105x80	13.5x11	180



CTR		GÜÇLENDİRİLMİŞ POLIAMİD KASNAK ÜZERİ TERMOELASTİK GRİ LASTİK KAPLAMA RULMANLI							
KOD NO									
	mm	mm	mm	mm	mm	mm	mm	kg	
3202 CTR 100 F18	100	35	135	48	156	140x110	105x80	13.5x11	120
3202 CTR 125 F18	125	40	161	49.5	156	140x110	105x80	13.5x11	150
3202 CTR 150 F18	150	45	184	55	156	140x110	105x80	13.5x11	180







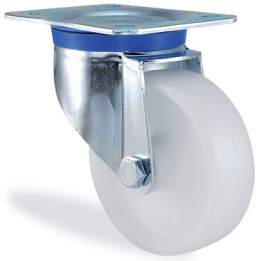

MLB		MOBLEN KASNAK ÜZERİ SİYAH DOLGU LASTİK KAPLAMA BURÇLU						
KOD NO	 mm	 mm	 mm	 mm	 mm	 mm	 mm	kg
3202 MLB 100	100	35	135	48	140x110	105x80	13.5x11	100
3202 MLB 125	125	40	161	49.5	140x110	105x80	13.5x11	130
3202 MLB 150	150	45	184	55	140x110	105x80	13.5x11	150









MLB		MOBLEN KASNAK ÜZERİ SİYAH DOLGU LASTİK KAPLAMA BURÇLU							
KOD NO	 mm	 mm	 mm	 mm	 mm	 mm	 mm	kg	
3202 MLB 100 F18	100	35	135	48	156	140x110	105x80	13.5x11	100
3202 MLB 125 F18	125	40	161	49.5	156	140x110	105x80	13.5x11	130
3202 MLB 150 F18	150	45	184	55	156	140x110	105x80	13.5x11	150







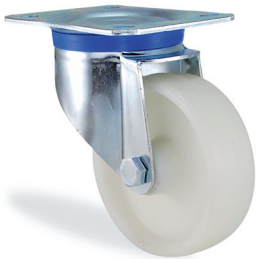

MMB		MOBLEN TEKER BURÇLU						
KOD NO	 mm	 mm	 mm	 mm	 mm	 mm	 mm	kg
3202 MMB 100	100	35	135	48	140x110	105x80	13.5x11	150
3202 MMB 125	125	40	161	49.5	140x110	105x80	13.5x11	170
3202 MMB 150	150	45	184	55	140x110	105x80	13.5x11	190









MMB		MOBLEN TEKER BURÇLU							
KOD NO	 mm	 mm	 mm	 mm	 mm	 mm	 mm	kg	
3202 MMB 100 F18	100	35	135	48	156	140x110	105x80	13.5x11	150
3202 MMB 125 F18	125	40	161	49.5	156	140x110	105x80	13.5x11	170
3202 MMB 150 F18	150	45	184	55	156	140x110	105x80	13.5x11	190



PPB		POLİAMİD TEKER BURÇLU						
KOD NO	 mm	 mm	 mm	 mm	 mm	 mm	 mm	kg
3202 PPB 100	100	35	135	48	140x110	105x80	13.5x11	170
3202 PPB 125	125	40	161	49.5	140x110	105x80	13.5x11	200
3202 PPB 150	150	45	184	55	140x110	105x80	13.5x11	230



PPB		POLİAMİD TEKER BURÇLU							
KOD NO	 mm	 mm	 mm	 mm	 mm	 mm	 mm	kg	
3202 PPB 100 F18	100	35	135	48	156	140x110	105x80	13.5x11	170
3202 PPB 125 F18	125	40	161	49.5	156	140x110	105x80	13.5x11	200
3202 PPB 150 F18	150	45	184	55	156	140x110	105x80	13.5x11	230



PYB		POLİAMİD KASNAK ÜZERİ AĞIR TİP VULKANİZE SİYAH LASTİK KAPLAMA BURÇLU						
KOD NO								
	mm	mm	mm	mm	mm	mm	mm	kg
3202 PYB 100	100	35	135	48	140x110	105x80	13.5x11	120
3202 PYB 125	125	40	161	49.5	140x110	105x80	13.5x11	150
3202 PYB 150	150	45	184	55	140x110	105x80	13.5x11	180



PYB		POLİAMİD KASNAK ÜZERİ AĞIR TİP VULKANİZE SİYAH LASTİK KAPLAMA BURÇLU							
KOD NO									
	mm	mm	mm	mm	mm	mm	mm	mm	kg
3202 PYB 100 F18	100	35	135	48	156	140x110	105x80	13.5x11	120
3202 PYB 125 F18	125	40	161	49.5	156	140x110	105x80	13.5x11	150
3202 PYB 150 F18	150	45	184	55	156	140x110	105x80	13.5x11	180



PYR		POLİAMİD KASNAK ÜZERİ AĞIR TİP VULKANİZE SİYAH LASTİK KAPLAMA RULMANLI							
KOD NO									
	mm	mm	mm	mm	mm	mm	mm	mm	kg
3202 PYR 100	100	35	135	48	140x110	105x80	13.5x11	120	
3202 PYR 125	125	40	161	49.5	140x110	105x80	13.5x11	150	
3202 PYR 150	150	45	184	55	140x110	105x80	13.5x11	180	



PYR		POLİAMİD KASNAK ÜZERİ AĞIR TİP VULKANİZE SİYAH LASTİK KAPLAMA RULMANLI							
KOD NO									
	mm	mm	mm	mm	mm	mm	mm	mm	kg
3202 PYR 100 F18	100	35	135	48	156	140x110	105x80	13.5x11	120
3202 PYR 125 F18	125	40	161	49.5	156	140x110	105x80	13.5x11	150
3202 PYR 150 F18	150	45	184	55	156	140x110	105x80	13.5x11	180



PUB		POLİAMİD KASNAK ÜZERİ POLİÜRETAN KAPLAMA BURÇLU							
KOD NO									
	mm	mm	mm	mm	mm	mm	mm	mm	kg
3202 PUB 100	100	35	135	48	140x110	105x80	13.5x11	180	
3202 PUB 125	125	40	161	49.5	140x110	105x80	13.5x11	250	
3202 PUB 150	150	45	184	55	140x110	105x80	13.5x11	300	



PUB		POLİAMİD KASNAK ÜZERİ POLİÜRETAN KAPLAMA BURÇLU							
KOD NO									
	mm	mm	mm	mm	mm	mm	mm	mm	kg
3202 PUB 100 F18	100	35	135	48	156	140x110	105x80	13.5x11	180
3202 PUB 125 F18	125	40	161	49.5	156	140x110	105x80	13.5x11	250
3202 PUB 150 F18	150	45	184	55	156	140x110	105x80	13.5x11	300



PUR		POLİAMİD KASNAK ÜZERİ POLİÜRETAN KAPLAMA RULMANLI						
KOD NO								
	mm	mm	mm	mm	mm	mm	mm	kg
3202 PUR 100	100	35	135	48	140x110	105x80	13.5x11	160
3202 PUR 125	125	40	161	49.5	140x110	105x80	13.5x11	250
3202 PUR 150	150	45	184	55	140x110	105x80	13.5x11	400



PUR		POLİAMİD KASNAK ÜZERİ POLİÜRETAN KAPLAMA RULMANLI							
KOD NO									
	mm	mm	mm	mm	mm	mm	mm	mm	kg
3202 PUR 100 F18	100	35	135	48	156	140x110	105x80	13.5x11	160
3202 PUR 125 F18	125	40	161	49.5	156	140x110	105x80	13.5x11	250
3202 PUR 150 F18	150	45	184	55	156	140x110	105x80	13.5x11	400



RMB		AĞIR TİP MOBLEN TEKER BURÇLU							
KOD NO									
	mm	mm	mm	mm	mm	mm	mm	mm	kg
3202 RMB 100	100	35	135	48	140x110	105x80	13.5x11	160	
3202 RMB 125	125	40	161	49.5	140x110	105x80	13.5x11	200	
3202 RMB 150	150	45	184	55	140x110	105x80	13.5x11	220	



RMB		AĞIR TİP MOBLEN TEKER BURÇLU							
KOD NO									
	mm	mm	mm	mm	mm	mm	mm	mm	kg
3202 RMB 100 F18	100	35	135	48	156	140x110	105x80	13.5x11	160
3202 RMB 125 F18	125	40	161	49.5	156	140x110	105x80	13.5x11	200
3202 RMB 150 F18	150	45	184	55	156	140x110	105x80	13.5x11	220



RPB		AĞIR TİP POLİAMİD TEKER BURÇLU							
KOD NO									
	mm	mm	mm	mm	mm	mm	mm	mm	kg
3202 RPB 100	100	35	135	48	140x110	105x80	13.5x11	250	
3202 RPB 125	125	40	161	49.5	140x110	105x80	13.5x11	300	
3202 RPB 150	150	45	184	55	140x110	105x80	13.5x11	400	



RPB		AĞIR TİP POLİAMİD TEKER BURÇLU							
KOD NO									
	mm	mm	mm	mm	mm	mm	mm	mm	kg
3202 RPB 100 F18	100	35	135	48	156	140x110	105x80	13.5x11	250
3202 RPB 125 F18	125	40	161	49.5	156	140x110	105x80	13.5x11	300
3202 RPB 150 F18	150	45	184	55	156	140x110	105x80	13.5x11	400



RPR		AĞIR TİP POLİAMİD TEKER RULMANLI						
KOD NO								
	mm	mm	mm	mm	mm	mm	mm	kg
3202 RPR 100	100	35	135	48	140x110	105x80	13.5x11	280
3202 RPR 125	125	40	161	49.5	140x110	105x80	13.5x11	300
3202 RPR 150	150	45	184	55	140x110	105x80	13.5x11	400



RPR		AĞIR TİP POLİAMİD TEKER RULMANLI							
KOD NO									
	mm	mm	mm	mm	mm	mm	mm	mm	kg
3202 RPR 100 F18	100	35	135	48	156	140x110	105x80	13.5x11	280
3202 RPR 125 F18	125	40	161	49.5	156	140x110	105x80	13.5x11	300
3202 RPR 150 F18	150	45	184	55	156	140x110	105x80	13.5x11	400



SLP		GALVANİZ KAPLI SAC ÜZERİ SİYAH KAUÇUK LASTİK KAPLAMA BURÇLU							
KOD NO									
	mm	mm	mm	mm	mm	mm	mm	mm	kg
3202 SLP 100	100	35	135	48	140x110	105x80	13.5x11	100	
3202 SLP 125	125	40	161	49.5	140x110	105x80	13.5x11	130	
3202 SLP 150	150	45	184	55	140x110	105x80	13.5x11	160	



SLP		GALVANİZ KAPLI SAC ÜZERİ SİYAH KAUÇUK LASTİK KAPLAMA BURÇLU							
KOD NO									
	mm	mm	mm	mm	mm	mm	mm	mm	kg
3202 SLP 100 F18	100	35	135	48	156	140x110	105x80	13.5x11	100
3202 SLP 125 F18	125	40	161	49.5	156	140x110	105x80	13.5x11	130
3202 SLP 150 F18	150	45	184	55	156	140x110	105x80	13.5x11	160











SLS		GALVANİZ KAPLI SAC ÜZERİ SİYAH KAUÇUK LASTİK KAPLAMA MASURALI							
KOD NO									
	mm	mm	mm	mm	mm	mm	mm	mm	kg
3202 SLS 100	100	35	135	48	140x110	105x80	13.5x11	100	
3202 SLS 125	125	40	161	49.5	140x110	105x80	13.5x11	130	
3202 SLS 150	150	45	184	55	140x110	105x80	13.5x11	160	











SLS		GALVANİZ KAPLI SAC ÜZERİ SİYAH KAUÇUK LASTİK KAPLAMA MASURALI							
KOD NO									
	mm	mm	mm	mm	mm	mm	mm	mm	kg
3202 SLS 100 F18	100	35	135	48	156	140x110	105x80	13.5x11	100
3202 SLS 125 F18	125	40	161	49.5	156	140x110	105x80	13.5x11	130
3202 SLS 150 F18	150	45	184	55	156	140x110	105x80	13.5x11	160

C2UR
GÜÇLENDİRİLMİŞ POLİAMİD KASNAK ÜZERİ POLİÜRETAN KAPLAMA RULMANLI

KOD NO	 mm	 mm	 mm	 mm	 mm	 mm	 mm	 kg
3202 C2UR 150	150	45	184	55	140x110	105x80	13.5x11	400

C2UR
GÜÇLENDİRİLMİŞ POLİAMİD KASNAK ÜZERİ POLİÜRETAN KAPLAMA RULMANLI

KOD NO	 mm	 mm	 mm	 mm	 mm	 mm	 mm	 mm	 kg
3202 C2UR 150 F18	150	45	184	55	156	140x110	105x80	13.5x11	400

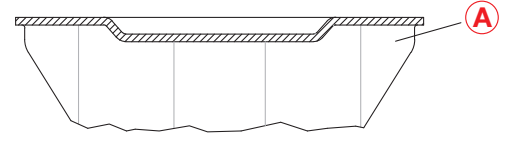
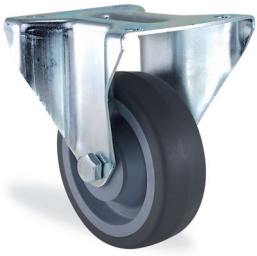
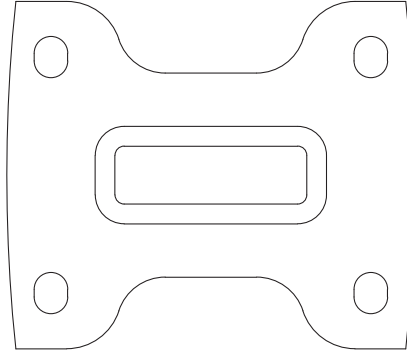
A: SABİT MAŞA

CTB		GÜÇLENDİRİLMİŞ POLIAMİD KASNAK ÜZERİ TERMOELASTİK GRİ LASTİK KAPLAMA BURÇLU						
KOD NO	mm	mm	mm	mm	mm	mm	kg	
3207 CTB 100	100	35	135	134x114	105x80	13.5x11	120	
3207 CTB 125	125	40	161	134x114	105x80	13.5x11	150	
3207 CTB 150	150	45	184	134x114	105x80	13.5x11	180	



CTR		GÜÇLENDİRİLMİŞ POLIAMİD KASNAK ÜZERİ TERMOELASTİK GRİ LASTİK KAPLAMA RULMANLI						
KOD NO	mm	mm	mm	mm	mm	mm	kg	
3207 CTR 100	100	35	135	134x114	105x80	13.5x11	120	
3207 CTR 125	125	40	161	134x114	105x80	13.5x11	150	
3207 CTR 150	150	45	184	134x114	105x80	13.5x11	180	



MLB		MOBLEN KASNAK ÜZERİ SİYAH DOLGU LASTİK KAPLAMA BURÇLU						
KOD NO	mm	mm	mm	mm	mm	mm	kg	
3207 MLB 100	100	35	135	134x114	105x80	13.5x11	100	
3207 MLB 125	125	40	161	134x114	105x80	13.5x11	130	
3207 MLB 150	150	45	184	134x114	105x80	13.5x11	150	

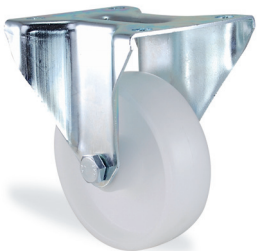

MMB		MOBLEN TEKER BURÇLU						
KOD NO	mm	mm	mm	mm	mm	mm	kg	
3207 MMB 100	100	35	135	134x114	105x80	13.5x11	150	
3207 MMB 125	125	40	161	134x114	105x80	13.5x11	170	
3207 MMB 150	150	45	184	134x114	105x80	13.5x11	190	

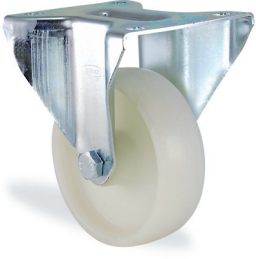

PPB		POLİAMİD TEKER BURÇLU						
KOD NO								
	mm	mm	mm	mm	mm	mm	kg	
3207 PPB 100	100	35	135	134x114	105x80	13.5x11	170	
3207 PPB 125	125	40	161	134x114	105x80	13.5x11	200	
3207 PPB 150	150	45	184	134x114	105x80	13.5x11	230	

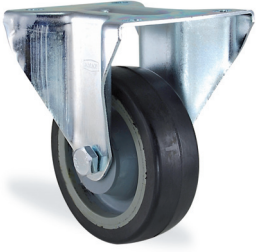

PYB		POLİAMİD KASNAK ÜZERİ AĞIR TİP VULKANİZE SİYAH LASTİK KAPLAMA BURÇLU						
KOD NO								
	mm	mm	mm	mm	mm	mm	kg	
3207 PYB 100	100	35	135	134x114	105x80	13.5x11	120	
3207 PYB 125	125	40	161	134x114	105x80	13.5x11	150	
3207 PYB 150	150	45	184	134x114	105x80	13.5x11	180	

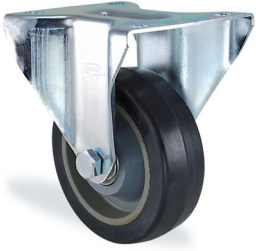

PYR		POLİAMİD KASNAK ÜZERİ AĞIR TİP VULKANİZE SİYAH LASTİK KAPLAMA RULMANLI						
KOD NO								
	mm	mm	mm	mm	mm	mm	kg	
3207 PYR 100	100	35	135	134x114	105x80	13.5x11	120	
3207 PYR 125	125	40	161	134x114	105x80	13.5x11	150	
3207 PYR 150	150	45	184	134x114	105x80	13.5x11	180	

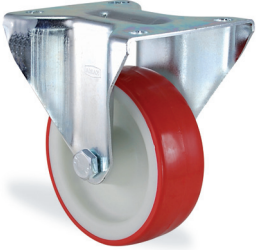

PUB		POLİAMİD KASNAK ÜZERİ POLİÜRETAN KAPLAMA BURÇLU						
KOD NO								
	mm	mm	mm	mm	mm	mm	kg	
3207 PUB 100	100	35	135	134x114	105x80	13.5x11	180	
3207 PUB 125	125	40	161	134x114	105x80	13.5x11	250	
3207 PUB 150	150	45	184	134x114	105x80	13.5x11	350	

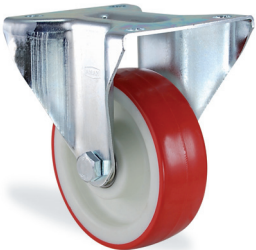



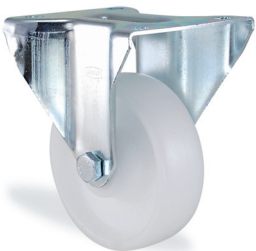

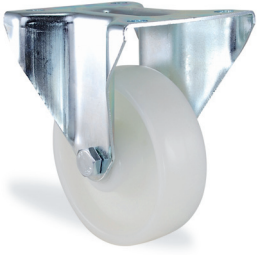

PUR		POLİAMİD KASNAK ÜZERİ POLİÜRETAN KAPLAMA RULMANLI						
KOD NO								
	mm	mm	mm	mm	mm	mm	kg	
3207 PUR 100	100	35	135	134x114	105x80	13.5x11	160	
3207 PUR 125	125	40	161	134x114	105x80	13.5x11	250	
3207 PUR 150	150	45	184	134x114	105x80	13.5x11	400	









RMB		AĞIR TİP MOBLEN TEKER BURÇLU						
KOD NO								
	mm	mm	mm	mm	mm	mm	kg	
3207 RMB 100	100	35	135	134x114	105x80	13.5x11	160	
3207 RMB 125	125	40	161	134x114	105x80	13.5x11	200	
3207 RMB 150	150	45	184	134x114	105x80	13.5x11	220	



RPB		AĞIR TİP POLİAMİD TEKER BURÇLU						
KOD NO								
	mm	mm	mm	mm	mm	mm	kg	
3207 RPB 100	100	35	135	134x114	105x80	13.5x11	250	
3207 RPB 125	125	40	161	134x114	105x80	13.5x11	300	
3207 RPB 150	150	45	184	134x114	105x80	13.5x11	400	



RPR		AĞIR TİP POLİAMİD TEKER RULMANLI						
KOD NO								
	mm	mm	mm	mm	mm	mm	kg	
3207 RPR 100	100	35	135	134x114	105x80	13.5x11	280	
3207 RPR 125	125	40	161	134x114	105x80	13.5x11	300	
3207 RPR 150	150	45	184	134x114	105x80	13.5x11	400	



SLP		GALVANİZ KAPLI SAC ÜZERİ SİYAH KAUÇUK LASTİK KAPLAMA BURÇLU						
KOD NO								
	mm	mm	mm	mm	mm	mm	kg	
3207 SLP 100	100	35	135	134x114	105x80	13.5x11	100	
3207 SLP 125	125	40	161	134x114	105x80	13.5x11	130	
3207 SLP 150	150	45	184	134x114	105x80	13.5x11	160	



SLS		GALVANİZ KAPLI SAC ÜZERİ SİYAH KAUÇUK LASTİK KAPLAMA MASURALI						
KOD NO								
	mm	mm	mm	mm	mm	mm	kg	
3207 SLS 100	100	35	135	134x114	105x80	13.5x11	100	
3207 SLS 125	125	40	161	134x114	105x80	13.5x11	130	
3207 SLS 150	150	45	184	134x114	105x80	13.5x11	160	



C2UR		GÜÇLENDİRİLMİŞ POLİAMİD KASNAK ÜZERİ POLİÜRETAN KAPLAMA RULMANLI						
KOD NO								
	mm	mm	mm	mm	mm	mm	kg	
3207 C2UR 150	150	45	184	134x114	105x80	13.5x11	400	

- A:** PASLANMAZ OYNAK BAĞLANTI TABLASI
- B:** PASLANMAZ OYNAK RULET MAŞASI
- C:** BİLYA MUHAFAZA TOZLUĞU
- D:** PASLANMAZ KÜRESEL TANE BİLYALAR
- E:** PASLANMAZ ALT BİLYA ÇANAĞI
- F:** PASLANMAZ TABLA PERÇİNİ
- G:** PASLANMAZ PUL

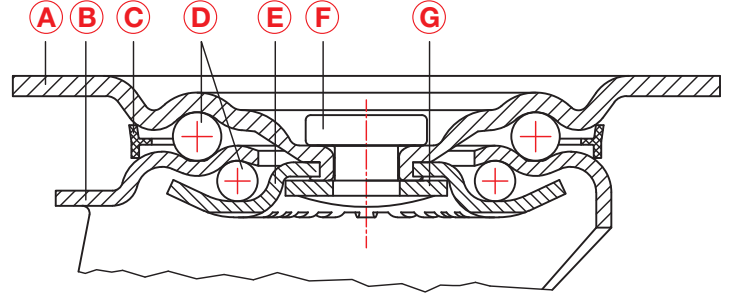

RPB		AĞIR TİP POLİAMİD TEKER BURÇLU						
KOD NO								
	mm	mm	mm	mm	mm	mm	mm	kg
S3202 RPB 100	100	35	141	50	140x110	105x80	13.5x11	250
S3202 RPB 125	125	40	164	52	140x110	105x80	13.5x11	300
S3202 RPB 150	150	45	190	53	140x110	105x80	13.5x11	400
S3202 RPB 200	200	50	240	62	140x110	105x80	13.5x11	400











RPB		AĞIR TİP POLİAMİD TEKER BURÇLU							
KOD NO									
	mm	mm	mm	mm	mm	mm	mm	mm	kg
S3202 RPB 100 F09	100	35	141	50	120	140x110	105x80	13.5x11	250
S3202 RPB 125 F09	125	40	164	52	120	140x110	105x80	13.5x11	300
S3202 RPB 150 F09	150	45	190	53	120	140x110	105x80	13.5x11	400
S3202 RPB 200 F09	200	50	240	62	120	140x110	105x80	13.5x11	400











RPB		AĞIR TİP POLİAMİD TEKER BURÇLU							
KOD NO									
	mm	mm	mm	mm	mm	mm	mm	mm	kg
S3202 RPB 100 F18	100	35	141	50	136	140x110	105x80	13.5x11	250
S3202 RPB 125 F18	125	40	164	52	138	140x110	105x80	13.5x11	300
S3202 RPB 150 F18	150	45	190	53	139	140x110	105x80	13.5x11	400
S3202 RPB 200 F18	200	50	240	62	153	140x110	105x80	13.5x11	400











RPR		AĞIR TİP POLİAMİD TEKER RULMANLI						
KOD NO	 mm	 mm	 mm	 mm	 mm	 mm	 mm	 kg
S3202 RPR 100	100	35	141	50	140x110	105x80	13.5x11	250
S3202 RPR 125	125	40	164	52	140x110	105x80	13.5x11	300
S3202 RPR 150	150	45	190	53	140x110	105x80	13.5x11	400
S3202 RPR 200	200	50	240	62	140x110	105x80	13.5x11	400











RPR		AĞIR TİP POLİAMİD TEKER RULMANLI							
KOD NO	 mm	 mm	 mm	 mm	 mm	 mm	 mm	 mm	 kg
S3202 RPR 100 F09	100	35	141	50	120	140x110	105x80	13.5x11	250
S3202 RPR 125 F09	125	40	164	52	120	140x110	105x80	13.5x11	300
S3202 RPR 150 F09	150	45	190	53	120	140x110	105x80	13.5x11	400
S3202 RPR 200 F09	200	50	240	62	120	140x110	105x80	13.5x11	400











RPR		AĞIR TİP POLİAMİD TEKER RULMANLI							
KOD NO	 mm	 mm	 mm	 mm	 mm	 mm	 mm	 mm	 kg
S3202 RPR 100 F18	100	35	141	50	136	140x110	105x80	13.5x11	250
S3202 RPR 125 F18	125	40	164	52	138	140x110	105x80	13.5x11	300
S3202 RPR 150 F18	150	45	190	53	139	140x110	105x80	13.5x11	400
S3202 RPR 200 F18	200	50	240	62	153	140x110	105x80	13.5x11	400



RMB		AĞIR TİP MOBLEN TEKER BURÇLU							
KOD NO	 mm	 mm	 mm	 mm	 mm	 mm	 mm	 mm	 kg
S3202 RMB 100	100	35	141	50		140x110	105x80	13.5x11	170
S3202 RMB 125	125	40	164	52		140x110	105x80	13.5x11	200
S3202 RMB 150	150	45	190	53		140x110	105x80	13.5x11	230
S3202 RMB 200	200	50	240	62		140x110	105x80	13.5x11	280











RMB		AĞIR TİP MOBLEN TEKER BURÇLU							
KOD NO	 mm	 mm	 mm	 mm	 mm	 mm	 mm	 mm	 kg
S3202 RMB 100 F09	100	35	141	50	120	140x110	105x80	13.5x11	170
S3202 RMB 125 F09	125	40	164	52	120	140x110	105x80	13.5x11	200
S3202 RMB 150 F09	150	45	190	53	120	140x110	105x80	13.5x11	230
S3202 RMB 200 F09	200	50	240	62	120	140x110	105x80	13.5x11	280



RMB









AĞIR TİP MOBLEN TEKER BURÇLU

KOD NO	 mm	 mm	 mm	 mm	 mm	 mm	 mm	 mm	 kg
S3202 RMB 100 F18	100	35	141	50	136	140x110	105x80	13.5x11	170
S3202 RMB 125 F18	125	40	164	52	138	140x110	105x80	13.5x11	200
S3202 RMB 150 F18	150	45	190	53	139	140x110	105x80	13.5x11	230
S3202 RMB 200 F18	200	50	240	62	153	140x110	105x80	13.5x11	280



CTB









GÜÇLENDİRİLMİŞ POLİAMİD KASNAK ÜZERİ TERMOELASTİK KAPLAMA BURÇLU

KOD NO	 mm	 mm	 mm	 mm	 mm	 mm	 mm	 mm	 kg
S3202 CTB 100	100	35	141	50	140x110	105x80	13.5x11	120	
S3202 CTB 125	125	40	164	52	140x110	105x80	13.5x11	150	
S3202 CTB 150	150	45	190	53	140x110	105x80	13.5x11	180	
S3202 CTB 200	200	50	240	62	140x110	105x80	13.5x11	250	



CTB









GÜÇLENDİRİLMİŞ POLİAMİD KASNAK ÜZERİ TERMOELASTİK KAPLAMA BURÇLU

KOD NO	 mm	 mm	 mm	 mm	 mm	 mm	 mm	 mm	 kg
S3202 CTB 100 F09	100	35	141	50	120	140x110	105x80	13.5x11	120
S3202 CTB 125 F09	125	40	164	52	120	140x110	105x80	13.5x11	150
S3202 CTB 150 F09	150	45	190	53	120	140x110	105x80	13.5x11	180
S3202 CTB 200 F09	200	50	240	62	120	140x110	105x80	13.5x11	250



CTB









GÜÇLENDİRİLMİŞ POLİAMİD KASNAK ÜZERİ TERMOELASTİK KAPLAMA BURÇLU

KOD NO	 mm	 mm	 mm	 mm	 mm	 mm	 mm	 mm	 kg
S3202 CTB 100 F18	100	35	141	50	136	140x110	105x80	13.5x11	120
S3202 CTB 125 F18	125	40	164	52	138	140x110	105x80	13.5x11	150
S3202 CTB 150 F18	150	45	190	53	139	140x110	105x80	13.5x11	180
S3202 CTB 200 F18	200	50	240	62	153	140x110	105x80	13.5x11	250











CTR









GÜÇLENDİRİLMİŞ POLİAMİD KASNAK ÜZERİ TERMOELASTİK KAPLAMA RULMANLI

KOD NO	 mm	 mm	 mm	 mm	 mm	 mm	 mm	 mm	 kg
S3202 CTR 100	100	35	141	50	140x110	105x80	13.5x11	120	
S3202 CTR 125	125	40	164	52	140x110	105x80	13.5x11	150	
S3202 CTR 150	150	45	190	53	140x110	105x80	13.5x11	180	
S3202 CTR 200	200	50	240	62	140x110	105x80	13.5x11	250	



CTR		GÜÇLENDİRİLMİŞ POLİAMİD KASNAK ÜZERİ TERMOELASTİK KAPLAMA RULMANLI							
KOD NO									
	mm	mm	mm	mm	mm	mm	mm	mm	kg
S3202 CTR 100 F09	100	35	141	50	120	140x110	105x80	13.5x11	120
S3202 CTR 125 F09	125	40	164	52	120	140x110	105x80	13.5x11	150
S3202 CTR 150 F09	150	45	190	53	120	140x110	105x80	13.5x11	180
S3202 CTR 200 F09	200	50	240	62	120	140x110	105x80	13.5x11	250



CTR		GÜÇLENDİRİLMİŞ POLİAMİD KASNAK ÜZERİ TERMOELASTİK KAPLAMA RULMANLI							
KOD NO									
	mm	mm	mm	mm	mm	mm	mm	mm	kg
S3202 CTR 100 F18	100	35	141	50	136	140x110	105x80	13.5x11	120
S3202 CTR 125 F18	125	40	164	52	138	140x110	105x80	13.5x11	150
S3202 CTR 150 F18	150	45	190	53	139	140x110	105x80	13.5x11	180
S3202 CTR 200 F18	200	50	240	62	153	140x110	105x80	13.5x11	250



PYB		POLİAMİD KASNAK ÜZERİ AĞIR TİP VULKANİZE SİYAH LASTİK KAPLAMA BURÇLU							
KOD NO									
	mm	mm	mm	mm	mm	mm	mm	mm	kg
S3202 PYB 100	100	35	141	50		140x110	105x80	13.5x11	120
S3202 PYB 125	125	40	164	52		140x110	105x80	13.5x11	150
S3202 PYB 150	150	45	190	53		140x110	105x80	13.5x11	180
S3202 PYB 200	200	50	240	62		140x110	105x80	13.5x11	250







PYB		POLİAMİD KASNAK ÜZERİ AĞIR TİP VULKANİZE SİYAH LASTİK KAPLAMA BURÇLU							
KOD NO									
	mm	mm	mm	mm	mm	mm	mm	mm	kg
S3202 PYB 100 F09	100	35	141	50	120	140x110	105x80	13.5x11	120
S3202 PYB 125 F09	125	40	164	52	120	140x110	105x80	13.5x11	150
S3202 PYB 150 F09	150	45	190	53	120	140x110	105x80	13.5x11	180
S3202 PYB 200 F09	200	50	240	62	120	140x110	105x80	13.5x11	250





PYB		POLİAMİD KASNAK ÜZERİ AĞIR TİP VULKANİZE SİYAH LASTİK KAPLAMA BURÇLU							
KOD NO									
	mm	mm	mm	mm	mm	mm	mm	mm	kg
S3202 PYB 100 F18	100	35	141	50	136	140x110	105x80	13.5x11	120
S3202 PYB 125 F18	125	40	164	52	138	140x110	105x80	13.5x11	150
S3202 PYB 150 F18	150	45	190	53	139	140x110	105x80	13.5x11	180
S3202 PYB 200 F18	200	50	240	62	153	140x110	105x80	13.5x11	250

S3202 Serisi (Paslanmaz)



PYR		POLİAMİD KASNAK ÜZERİ AĞIR TİP VULKANİZE SİYAH LASTİK KAPLAMA RULMANLI						
KOD NO								kg
S3202 PYR 100	100	35	141	50	140x110	105x80	13.5x11	120
S3202 PYR 125	125	40	164	52	140x110	105x80	13.5x11	150
S3202 PYR 150	150	45	190	53	140x110	105x80	13.5x11	180
S3202 PYR 200	200	50	240	62	140x110	105x80	13.5x11	250









PYR		POLİAMİD KASNAK ÜZERİ AĞIR TİP VULKANİZE SİYAH LASTİK KAPLAMA RULMANLI							
KOD NO								kg	
S3202 PYR 100 F09	100	35	141	50	120	140x110	105x80	13.5x11	120
S3202 PYR 125 F09	125	40	164	52	120	140x110	105x80	13.5x11	150
S3202 PYR 150 F09	150	45	190	53	120	140x110	105x80	13.5x11	180
S3202 PYR 200 F09	200	50	240	62	120	140x110	105x80	13.5x11	250





PYR		POLİAMİD KASNAK ÜZERİ AĞIR TİP VULKANİZE SİYAH LASTİK KAPLAMA RULMANLI							
KOD NO								kg	
S3202 PYR 100 F18	100	35	141	50	136	140x110	105x80	13.5x11	120
S3202 PYR 125 F18	125	40	164	52	138	140x110	105x80	13.5x11	150
S3202 PYR 150 F18	150	45	190	53	139	140x110	105x80	13.5x11	180
S3202 PYR 200 F18	200	50	240	62	153	140x110	105x80	13.5x11	250











PUB		POLİAMİD KASNAK ÜZERİ POLİÜRETAN KAPLAMA BURÇLU						
KOD NO								kg
S3202 PUB 100	100	35	141	50	140x110	105x80	13.5x11	180
S3202 PUB 125	125	40	164	52	140x110	105x80	13.5x11	250
S3202 PUB 150	150	45	190	53	140x110	105x80	13.5x11	350
S3202 PUB 200	200	50	240	62	140x110	105x80	13.5x11	400











PUB		POLİAMİD KASNAK ÜZERİ POLİÜRETAN KAPLAMA BURÇLU							
KOD NO								kg	
S3202 PUB 100 F09	100	35	141	50	120	140x110	105x80	13.5x11	180
S3202 PUB 125 F09	125	40	164	52	120	140x110	105x80	13.5x11	250
S3202 PUB 150 F09	150	45	190	53	120	140x110	105x80	13.5x11	350
S3202 PUB 200 F09	200	50	240	62	120	140x110	105x80	13.5x11	400











PUB		POLİAMİD KASNAK ÜZERİ POLİÜRETAN KAPLAMA BURÇLU							
KOD NO									
	mm	mm	mm	mm	mm	mm	mm	mm	kg
S3202 PUB 100 F18	100	35	141	50	136	140x110	105x80	13.5x11	180
S3202 PUB 125 F18	125	40	164	52	138	140x110	105x80	13.5x11	250
S3202 PUB 150 F18	150	45	190	53	139	140x110	105x80	13.5x11	350
S3202 PUB 200 F18	200	50	240	62	153	140x110	105x80	13.5x11	400











PUR		POLİAMİD KASNAK ÜZERİ POLİÜRETAN KAPLAMA RULMANLI							
KOD NO									
	mm	mm	mm	mm	mm	mm	mm	mm	kg
S3202 PUR 100	100	35	141	50	136	140x110	105x80	13.5x11	180
S3202 PUR 125	125	40	164	52	138	140x110	105x80	13.5x11	250
S3202 PUR 150	150	45	190	53	139	140x110	105x80	13.5x11	400
S3202 PUR 200	200	50	240	62	153	140x110	105x80	13.5x11	400



PUR		POLİAMİD KASNAK ÜZERİ POLİÜRETAN KAPLAMA RULMANLI							
KOD NO									
	mm	mm	mm	mm	mm	mm	mm	mm	kg
S3202 PUR 100 F09	100	35	141	50	120	140x110	105x80	13.5x11	180
S3202 PUR 125 F09	125	40	164	52	120	140x110	105x80	13.5x11	250
S3202 PUR 150 F09	150	45	190	53	120	140x110	105x80	13.5x11	400
S3202 PUR 200 F09	200	50	240	62	120	140x110	105x80	13.5x11	400



PUR		POLİAMİD KASNAK ÜZERİ POLİÜRETAN KAPLAMA RULMANLI							
KOD NO									
	mm	mm	mm	mm	mm	mm	mm	mm	kg
S3202 PUR 100 F18	100	35	141	50	136	140x110	105x80	13.5x11	180
S3202 PUR 125 F18	125	40	164	52	138	140x110	105x80	13.5x11	250
S3202 PUR 150 F18	150	45	190	53	139	140x110	105x80	13.5x11	400
S3202 PUR 200 F18	200	50	240	62	153	140x110	105x80	13.5x11	400



MLB		MOBLEN KASNAK ÜZERİ SİYAH DOLGU LASTİK KAPLAMA BURÇLU							
KOD NO									
	mm	mm	mm	mm	mm	mm	mm	mm	kg
S3202 MLB 100	100	35	141	50	136	140x110	105x80	13.5x11	100
S3202 MLB 125	125	40	164	52	138	140x110	105x80	13.5x11	130
S3202 MLB 150	150	45	190	53	139	140x110	105x80	13.5x11	150
S3202 MLB 200	200	50	240	62	153	140x110	105x80	13.5x11	220











MLB		MOBLEN KASNAK ÜZERİ SİYAH DOLGU LASTİK KAPLAMA BURÇLU							
KOD NO									
	mm	mm	mm	mm	mm	mm	mm	mm	kg
S3202 MLB 100 F09	100	35	141	50	120	140x110	105x80	13.5x11	100
S3202 MLB 125 F09	125	40	164	52	120	140x110	105x80	13.5x11	130
S3202 MLB 150 F09	150	45	190	53	120	140x110	105x80	13.5x11	150
S3202 MLB 200 F09	200	50	240	62	120	140x110	105x80	13.5x11	220











MLB		MOBLEN KASNAK ÜZERİ SİYAH DOLGU LASTİK KAPLAMA BURÇLU							
KOD NO									
	mm	mm	mm	mm	mm	mm	mm	mm	kg
S3202 MLB 100 F18	100	35	141	50	136	140x110	105x80	13.5x11	100
S3202 MLB 125 F18	125	40	164	52	138	140x110	105x80	13.5x11	130
S3202 MLB 150 F18	150	45	190	53	139	140x110	105x80	13.5x11	150
S3202 MLB 200 F18	200	50	240	62	153	140x110	105x80	13.5x11	220











MMB		MOBLEN TEKER BURÇLU							
KOD NO									
	mm	mm	mm	mm	mm	mm	mm	mm	kg
S3202 MMB 100	100	35	141	50		140x110	105x80	13.5x11	150
S3202 MMB 125	125	40	164	52		140x110	105x80	13.5x11	170
S3202 MMB 150	150	45	190	53		140x110	105x80	13.5x11	190
S3202 MMB 200	200	50	240	62		140x110	105x80	13.5x11	250











MMB		MOBLEN TEKER BURÇLU							
KOD NO									
	mm	mm	mm	mm	mm	mm	mm	mm	kg
S3202 MMB 100 F09	100	35	141	50	120	140x110	105x80	13.5x11	150
S3202 MMB 125 F09	125	40	164	52	120	140x110	105x80	13.5x11	170
S3202 MMB 150 F09	150	45	190	53	120	140x110	105x80	13.5x11	190
S3202 MMB 200 F09	200	50	240	62	120	140x110	105x80	13.5x11	250











MMB		MOBLEN TEKER BURÇLU							
KOD NO									
	mm	mm	mm	mm	mm	mm	mm	mm	kg
S3202 MMB 100 F18	100	35	141	50	136	140x110	105x80	13.5x11	150
S3202 MMB 125 F18	125	40	164	52	138	140x110	105x80	13.5x11	170
S3202 MMB 150 F18	150	45	190	53	139	140x110	105x80	13.5x11	190
S3202 MMB 200 F18	200	50	240	62	153	140x110	105x80	13.5x11	250











PPB		POLİAMİD TEKER BURÇLU							
KOD NO									
	mm	mm	mm	mm	mm	mm	mm	kg	
S3202 PPB 100	100	35	141	50	140x110	105x80	13.5x11	170	
S3202 PPB 125	125	40	164	52	140x110	105x80	13.5x11	200	
S3202 PPB 150	150	45	190	53	140x110	105x80	13.5x11	250	
S3202 PPB 200	200	50	240	62	140x110	105x80	13.5x11	280	



PPB		POLİAMİD TEKER BURÇLU							
KOD NO									
	mm	mm	mm	mm	mm	mm	mm	mm	kg
S3202 PPB 100 F09	100	35	141	50	120	140x110	105x80	13.5x11	170
S3202 PPB 125 F09	125	40	164	52	120	140x110	105x80	13.5x11	200
S3202 PPB 150 F09	150	45	190	53	120	140x110	105x80	13.5x11	250
S3202 PPB 200 F09	200	50	240	62	120	140x110	105x80	13.5x11	280

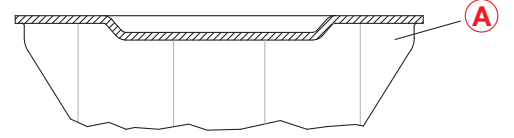
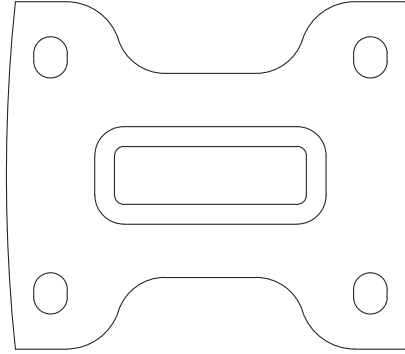

PPB		POLİAMİD TEKER BURÇLU							
KOD NO									
	mm	mm	mm	mm	mm	mm	mm	mm	kg
S3202 PPB 100 F18	100	35	141	50	136	140x110	105x80	13.5x11	170
S3202 PPB 125 F18	125	40	164	52	138	140x110	105x80	13.5x11	200
S3202 PPB 150 F18	150	45	190	53	139	140x110	105x80	13.5x11	250
S3202 PPB 200 F18	200	50	240	62	153	140x110	105x80	13.5x11	280

A: SABİT MAŞA

RPB		AĞIR TİP POLİAMİD TEKER BURÇLU					
KOD NO	mm	mm	mm	mm	mm	mm	kg
S3207 RPB 100	100	35	141	134x114	105x80	13.5x11	250
S3207 RPB 125	125	40	165	134x114	105x80	13.5x11	300
S3207 RPB 150	150	45	190	134x114	105x80	13.5x11	400
S3207 RPB 200	200	50	234	134x114	105x80	13.5x11	400









RPR		AĞIR TİP POLİAMİD TEKER RULMANLI					
KOD NO	mm	mm	mm	mm	mm	mm	kg
S3207 RPR 100	100	35	141	134x114	105x80	13.5x11	250
S3207 RPR 125	125	40	165	134x114	105x80	13.5x11	300
S3207 RPR 150	150	45	190	134x114	105x80	13.5x11	400
S3207 RPR 200	200	50	234	134x114	105x80	13.5x11	400









RMB		AĞIR TİP MOBLEN TEKER BURÇLU					
KOD NO	mm	mm	mm	mm	mm	mm	kg
S3207 RMB 100	100	35	141	134x114	105x80	13.5x11	170
S3207 RMB 125	125	40	165	134x114	105x80	13.5x11	200
S3207 RMB 150	150	45	190	134x114	105x80	13.5x11	230
S3207 RMB 200	200	50	234	134x114	105x80	13.5x11	280





CTB		GÜÇLENDİRİLMİŞ POLİAMİD KASNAK ÜZERİ TERMOELASTİK KAPLAMA BURÇLU					
KOD NO							
	mm	mm	mm	mm	mm	mm	kg
S3207 CTB 100	100	35	141	134x114	105x80	13.5x11	120
S3207 CTB 125	125	40	165	134x114	105x80	13.5x11	150
S3207 CTB 150	150	45	190	134x114	105x80	13.5x11	180
S3207 CTB 200	200	50	234	134x114	105x80	13.5x11	250



CTR		GÜÇLENDİRİLMİŞ POLİAMİD KASNAK ÜZERİ TERMOELASTİK KAPLAMA RULMANLI					
KOD NO							
	mm	mm	mm	mm	mm	mm	kg
S3207 CTR 100	100	35	141	134x114	105x80	13.5x11	120
S3207 CTR 125	125	40	165	134x114	105x80	13.5x11	150
S3207 CTR 150	150	45	190	134x114	105x80	13.5x11	180
S3207 CTR 200	200	50	234	134x114	105x80	13.5x11	250



PYB		POLİAMİD KASNAK ÜZERİ AĞIR TİP VULKANİZE SİYAH LASTİK KAPLAMA BURÇLU					
KOD NO							
	mm	mm	mm	mm	mm	mm	kg
S3207 PYB 100	100	35	141	134x114	105x80	13.5x11	120
S3207 PYB 125	125	40	165	134x114	105x80	13.5x11	150
S3207 PYB 150	150	45	190	134x114	105x80	13.5x11	180
S3207 PYB 200	200	50	234	134x114	105x80	13.5x11	250









PYR		POLİAMİD KASNAK ÜZERİ AĞIR TİP VULKANİZE SİYAH LASTİK KAPLAMA RULMANLI					
KOD NO							
	mm	mm	mm	mm	mm	mm	kg
S3207 PYR 100	100	35	141	134x114	105x80	13.5x11	120
S3207 PYR 125	125	40	165	134x114	105x80	13.5x11	150
S3207 PYR 150	150	45	190	134x114	105x80	13.5x11	180
S3207 PYR 200	200	50	234	134x114	105x80	13.5x11	250



PUB		POLİAMİD KASNAK ÜZERİ POLİÜRETAN KAPLAMA BURÇLU					
KOD NO							
	mm	mm	mm	mm	mm	mm	kg
S3207 PUB 100	100	35	141	134x114	105x80	13.5x11	180
S3207 PUB 125	125	40	165	134x114	105x80	13.5x11	250
S3207 PUB 150	150	45	190	134x114	105x80	13.5x11	350
S3207 PUB 200	200	50	234	134x114	105x80	13.5x11	400









PUR		POLİAMİD KASNAK ÜZERİ POLİÜRETAN KAPLAMA RULMANLI						
KOD NO	 mm	 mm	 mm	 mm	 mm	 mm	 kg	
S3207 PUR 100	100	35	141	134x114	105x80	13.5x11	180	
S3207 PUR 125	125	40	165	134x114	105x80	13.5x11	250	
S3207 PUR 150	150	45	190	134x114	105x80	13.5x11	400	
S3207 PUR 200	200	50	234	134x114	105x80	13.5x11	400	









MLB		MOBLEN KASNAK ÜZERİ SİYAH DOLGU LASTİK KAPLAMA BURÇLU						
KOD NO	 mm	 mm	 mm	 mm	 mm	 mm	 kg	
S3207 MLB 100	100	35	141	134x114	105x80	13.5x11	100	
S3207 MLB 125	125	40	165	134x114	105x80	13.5x11	130	
S3207 MLB 150	150	45	190	134x114	105x80	13.5x11	150	
S3207 MLB 200	200	50	234	134x114	105x80	13.5x11	220	



MMB		MOBLEN TEKER BURÇLU						
KOD NO	 mm	 mm	 mm	 mm	 mm	 mm	 kg	
S3207 MMB 100	100	35	141	134x114	105x80	13.5x11	150	
S3207 MMB 125	125	40	165	134x114	105x80	13.5x11	170	
S3207 MMB 150	150	45	190	134x114	105x80	13.5x11	190	
S3207 MMB 200	200	50	234	134x114	105x80	13.5x11	250	



PPB		POLİAMİD TEKER BURÇLU						
KOD NO	 mm	 mm	 mm	 mm	 mm	 mm	 kg	
S3207 PPB 100	100	35	141	134x114	105x80	13.5x11	170	
S3207 PPB 125	125	40	165	134x114	105x80	13.5x11	200	
S3207 PPB 150	150	45	190	134x114	105x80	13.5x11	250	
S3207 PPB 200	200	50	234	134x114	105x80	13.5x11	280	

- A:** ÜST BİLYA KAPAĞI
B: KÜRESEL METAL TANE BİLYALAR
C: ALT BİLYA ÇANAĞI
D: BORU PERÇİNİ
E: OYNAK RULET MAŞASI

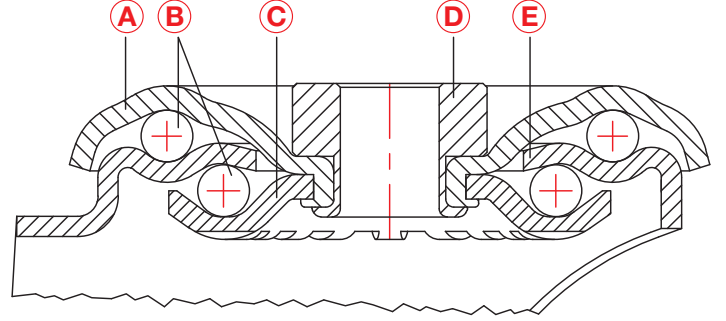

PRS		POLİAMİD KASNAK ÜZERİ MAVİ KAUÇUK LASTİK KAPLAMA MASURALI					
KOD NO	mm	mm	mm	mm	mm	kg	
3300 PRS 080	80	32	106	41	12	80	
3300 PRS 100	100	36	129	42	12	120	
3300 PRS 125	125	36	155	38	12	150	
3300 PRS 150	150	40	181	38	12	200	







PRS		POLİAMİD KASNAK ÜZERİ MAVİ KAUÇUK LASTİK KAPLAMA MASURALI					
KOD NO	mm	mm	mm	mm	mm	kg	
3300 PRS 080 F18	80	32	106	41	120	80	
3300 PRS 100 F18	100	36	129	42	120	120	
3300 PRS 125 F18	125	36	155	38	120	150	
3300 PRS 150 F18	150	40	181	38	120	200	







PUB		POLİAMİD KASNAK ÜZERİ POLİÜRETAN KAPLAMA BURÇLU					
KOD NO	mm	mm	mm	mm	mm	kg	
3300 PUB 080	80	30	106	41	12	125	
3300 PUB 100	100	30	129	42	12	150	
3300 PUB 125	125	37.5	155	38	12	180	
3300 PUB 150	150	40	181	38	12	260	









PUB		POLİAMİD KASNAK ÜZERİ POLİÜRETAN KAPLAMA BURÇLU					
KOD NO	 mm	 mm	 mm	 mm	 mm	 kg	
3300 PUB 200	200	50	241	52	12	400	









PUB		POLİAMİD KASNAK ÜZERİ POLİÜRETAN KAPLAMA BURÇLU					
KOD NO	 mm	 mm	 mm	 mm	 mm	 mm	 kg
3300 PUB 080 F18	80	30	106	41	120	12	125
3300 PUB 100 F18	100	30	129	42	120	12	150
3300 PUB 125 F18	125	37.5	155	38	120	12	180









PUB		POLİAMİD KASNAK ÜZERİ POLİÜRETAN KAPLAMA BURÇLU					
KOD NO	 mm	 mm	 mm	 mm	 mm	 mm	 kg
3300 PUB 150 F18	150	40	181	38	120	12	260
3300 PUB 200 F18	200	50	241	52	150	12	400









PUR		POLİAMİD KASNAK ÜZERİ POLİÜRETAN KAPLAMA RULMANLI					
KOD NO	 mm	 mm	 mm	 mm	 mm	 kg	
3300 PUR 080	80	32	106	41	12	125	
3300 PUR 100	100	32	129	42	12	150	
3300 PUR 125	125	32	155	38	12	180	









PUR		POLİAMİD KASNAK ÜZERİ POLİÜRETAN KAPLAMA RULMANLI					
KOD NO	 mm	 mm	 mm	 mm	 mm	 kg	
3300 PUR 200	200	50	241	52	12	400	



PUR		POLİAMİD KASNAK ÜZERİ POLİÜRETAN KAPLAMA RULMANLI					
KOD NO	 mm	 mm	 mm	 mm	 mm	 mm	 kg
3300 PUR 080 F18	80	32	106	41	120	12	125
3300 PUR 100 F18	100	32	129	42	120	12	150
3300 PUR 125 F18	125	32	155	38	120	12	180









PUR		POLİAMİD KASNAK ÜZERİ POLİÜRETAN KAPLAMA RULMANLI					
KOD NO	 mm	 mm	 mm	 mm	 mm	 mm	 kg
3300 PUR 200 F18	200	50	241	52	150	12	400



PUS		POLİAMİD KASNAK ÜZERİ POLİÜRETAN KAPLAMA MASURALI					
KOD NO	 mm	 mm	 mm	 mm	 mm	 mm	 kg
3300 PUS 080	80	30	106	41	12		125
3300 PUS 100	100	30	129	42	12		150
3300 PUS 125	125	35	155	38	12		180









PUS		POLİAMİD KASNAK ÜZERİ POLİÜRETAN KAPLAMA MASURALI					
KOD NO	 mm	 mm	 mm	 mm	 mm	 mm	 kg
3300 PUS 150	150	40	181	38	12		260
3300 PUS 200	200	50	241	52	12		400



PUS		POLİAMİD KASNAK ÜZERİ POLİÜRETAN KAPLAMA MASURALI					
KOD NO	 mm	 mm	 mm	 mm	 mm	 mm	 kg
3300 PUS 080 F18	80	30	106	41	120	12	125
3300 PUS 100 F18	100	30	129	42	120	12	150
3300 PUS 125 F18	125	35	155	38	120	12	180



PUS		POLİAMİD KASNAK ÜZERİ POLİÜRETAN KAPLAMA MASURALI					
KOD NO	 mm	 mm	 mm	 mm	 mm	 mm	 kg
3300 PUS 150 F18	150	40	181	38	120	12	260
3300 PUS 200 F18	200	50	241	52	150	12	400



SLP		GALVANİZ KAPLI SAC ÜZERİ SİYAH KAUÇUK LASTİK KAPLAMA POLİAMİD BURÇLU				
KOD NO	 mm	 mm	 mm	 mm	 mm	 kg
3300 SLP 080	80	25	106	41	12	50
3300 SLP 100	100	30	129	42	12	70
3300 SLP 125	125	37.5	155	38	12	100
3300 SLP 140	140	37.5	177	38	12	115
3300 SLP 150	150	38	181	38	12	125
3300 SLP 160	160	38	199	54	12	135
3300 SLP 180	180	45	220	55	12	170
3300 SLP 200	200	50	241	52	12	205









SLP		GALVANİZ KAPLI SAC ÜZERİ SİYAH KAUÇUK LASTİK KAPLAMA POLİAMİD BURÇLU					
KOD NO	 mm	 mm	 mm	 mm	 mm	 mm	 kg
3300 SLP 080 F18	80	25	106	41	120	12	50
3300 SLP 100 F18	100	30	129	42	120	12	70
3300 SLP 125 F18	125	37.5	155	38	120	12	100
3300 SLP 140 F18	140	37.5	177	38	120	12	115
3300 SLP 150 F18	150	38	181	38	120	12	125
3300 SLP 160 F18	160	38	199	54	150	12	135
3300 SLP 180 F18	180	45	220	55	150	12	170
3300 SLP 200 F18	200	50	241	52	150	12	205









SLS		GALVANİZ KAPLI SAC ÜZERİ SİYAH KAUÇUK LASTİK KAPLAMA MASURALI				
KOD NO	 mm	 mm	 mm	 mm	 mm	 kg
3300 SLS 080	80	25	106	41	12	50
3300 SLS 100	100	30	129	42	12	70
3300 SLS 125	125	37.5	155	38	12	100
3300 SLS 140	140	37.5	177	38	12	115
3300 SLS 150	150	38	181	38	12	125
3300 SLS 160	160	38	199	54	12	135
3300 SLS 180	180	45	220	55	12	170
3300 SLS 200	200	50	241	52	12	205









SLS
GALVANİZ KAPLI SAC ÜZERİ SİYAH KAUÇUK LASTİK KAPLAMA MASURALI

KOD NO	 mm	 mm	 mm	 mm	 mm	 mm	 kg
3300 SLS 080 F18	80	25	106	41	120	12	50
3300 SLS 100 F18	100	30	129	42	120	12	70
3300 SLS 125 F18	125	37.5	155	38	120	12	100
3300 SLS 140 F18	140	37.5	177	38	120	12	115
3300 SLS 150 F18	150	38	181	38	120	12	125
3300 SLS 160 F18	160	38	199	54	150	12	135
3300 SLS 180 F18	180	45	220	55	150	12	170
3300 SLS 200 F18	200	50	241	52	150	12	205







SES
GALVANİZ KAPLI SAC ÜZERİ GRİ KAUÇUK LASTİK KAPLAMA MASURALI

KOD NO	 mm	 mm	 mm	 mm	 mm	 mm	 kg
3300 SES 080	80	25	106	41	12	12	50
3300 SES 100	100	30	129	42	12	12	70
3300 SES 125	125	37.5	155	38	12	12	100
3300 SES 140	140	37.5	177	38	12	12	115
3300 SES 150	150	38	181	38	12	12	125
3300 SES 160	160	38	199	54	12	12	135
3300 SES 180	180	45	220	55	12	12	170
3300 SES 200	200	50	241	52	12	12	205









SES
GALVANİZ KAPLI SAC ÜZERİ GRİ KAUÇUK LASTİK KAPLAMA MASURALI

KOD NO	 mm	 mm	 mm	 mm	 mm	 mm	 kg
3300 SES 080 F18	80	25	106	41	120	12	50
3300 SES 100 F18	100	30	129	42	120	12	70
3300 SES 125 F18	125	37.5	155	38	120	12	100
3300 SES 140 F18	140	37.5	177	38	120	12	115
3300 SES 150 F18	150	38	181	38	120	12	125
3300 SES 160 F18	160	38	199	54	150	12	135
3300 SES 180 F18	180	45	220	55	150	12	170
3300 SES 200 F18	200	50	241	52	150	12	205







MLB
MOBLEN KASNAK ÜZERİ SİYAH DOLGU LASTİK KAPLAMA BURÇLU

KOD NO	 mm	 mm	 mm	 mm	 mm	 kg
3300 MLB 080	80	25	106	41	12	50
3300 MLB 100	100	30	129	42	12	70
3300 MLB 125	125	37.5	155	38	12	100
3300 MLB 140	140	37.5	177	38	12	115
3300 MLB 150	150	40	181	38	12	125
3300 MLB 160	160	40	199	54	12	135
3300 MLB 180	180	45	220	55	12	170
3300 MLB 200	200	50	241	52	12	220

MLB
MOBLEN KASNAK ÜZERİ SİYAH DOLGU LASTİK KAPLAMA BURÇLU

KOD NO	 mm	 mm	 mm	 mm	 mm	 mm	 kg
3300 MLB 080 F18	80	25	106	41	120	12	50
3300 MLB 100 F18	100	30	129	42	120	12	70
3300 MLB 125 F18	125	37.5	155	38	120	12	100
3300 MLB 140 F18	140	37.5	177	38	120	12	115
3300 MLB 150 F18	150	40	181	38	120	12	125
3300 MLB 160 F18	160	40	199	54	150	12	135
3300 MLB 180 F18	180	45	220	55	150	12	170
3300 MLB 200 F18	200	50	241	52	150	12	220

MLS
MOBLEN KASNAK ÜZERİ SİYAH DOLGU LASTİK KAPLAMA MASURALI

KOD NO	 mm	 mm	 mm	 mm	 mm	 kg
3300 MLS 080	80	30	106	41	12	50
3300 MLS 100	100	30	129	42	12	70
3300 MLS 125	125	37.5	155	38	12	100
3300 MLS 140	140	37.5	177	38	12	115
3300 MLS 150	150	40	181	38	12	125
3300 MLS 160	160	40	199	54	12	135
3300 MLS 180	180	45	220	55	12	170
3300 MLS 200	200	50	241	52	12	220



MLS		MOBLEN KASNAK ÜZERİ SİYAH DOLGU LASTİK KAPLAMA MASURALI					
KOD NO	 mm	 mm	 mm	 mm	 mm	 mm	 kg
3300 MLS 080 F18	80	30	106	41	120	12	50
3300 MLS 100 F18	100	30	129	42	120	12	70
3300 MLS 125 F18	125	37.5	155	38	120	12	100
3300 MLS 140 F18	140	37.5	177	38	120	12	115
3300 MLS 150 F18	150	40	181	38	120	12	125
3300 MLS 160 F18	160	40	199	54	150	12	135
3300 MLS 180 F18	180	45	220	55	150	12	170
3300 MLS 200 F18	200	50	241	52	150	12	220



MES		MOBLEN KASNAK ÜZERİ GRİ DOLGU LASTİK KAPLAMA MASURALI					
KOD NO	 mm	 mm	 mm	 mm	 mm	 mm	 kg
3300 MES 080	80	30	106	41	12	12	50
3300 MES 100	100	30	129	42	12	12	70
3300 MES 125	125	37.5	155	38	12	12	100
3300 MES 140	140	37.5	177	38	12	12	115
3300 MES 150	150	40	181	38	12	12	125
3300 MES 160	160	40	199	54	12	12	135
3300 MES 180	180	45	220	55	12	12	170
3300 MES 200	200	50	241	52	12	12	220









MES		MOBLEN KASNAK ÜZERİ GRİ DOLGU LASTİK KAPLAMA MASURALI					
KOD NO	 mm	 mm	 mm	 mm	 mm	 mm	 kg
3300 MES 080 F18	80	30	106	41	120	12	50
3300 MES 100 F18	100	30	129	42	120	12	70
3300 MES 125 F18	125	37.5	155	38	120	12	100
3300 MES 140 F18	140	37.5	177	38	120	12	115
3300 MES 150 F18	150	40	181	38	120	12	125
3300 MES 160 F18	160	40	199	54	150	12	135
3300 MES 180 F18	180	45	220	55	150	12	170
3300 MES 200 F18	200	50	241	52	150	12	220









MMB		MOBLEN TEKER BURÇLU					
KOD NO	 mm	 mm	 mm	 mm	 mm	 kg	
3300 MMB 064	64	30	99	41	12	80	
3300 MMB 080	80	30	106	41	12	100	
3300 MMB 100	100	30	129	42	12	110	
3300 MMB 125	125	37.5	155	38	12	150	
3300 MMB 140	140	37.5	177	38	12	160	
3300 MMB 150	150	40	181	38	12	180	
3300 MMB 160	160	40	199	54	12	210	
3300 MMB 180	180	45	220	55	12	230	
3300 MMB 200	200	50	241	52	12	250	









MMB		MOBLEN TEKER BURÇLU					
KOD NO	 mm	 mm	 mm	 mm	 mm	 mm	 kg
3300 MMB 064 F18	64	30	99	41	120	12	80
3300 MMB 080 F18	80	30	106	41	120	12	100
3300 MMB 100 F18	100	30	129	42	120	12	110
3300 MMB 125 F18	125	37.5	155	38	120	12	150
3300 MMB 140 F18	140	37.5	177	38	120	12	160
3300 MMB 150 F18	150	40	181	38	120	12	180
3300 MMB 160 F18	160	40	199	54	150	12	210
3300 MMB 180 F18	180	45	220	55	150	12	230
3300 MMB 200 F18	200	50	241	52	150	12	250









MMS		MOBLEN TEKER MASURALI					
KOD NO	 mm	 mm	 mm	 mm	 mm	 kg	
3300 MMS 064	64	30	99	41	12	80	
3300 MMS 080	80	30	106	41	12	100	
3300 MMS 100	100	30	129	42	12	110	
3300 MMS 125	125	37.5	155	38	12	150	
3300 MMS 140	140	37.5	177	38	12	160	
3300 MMS 150	150	40	181	38	12	180	
3300 MMS 160	160	40	199	54	12	210	
3300 MMS 180	180	45	220	55	12	230	
3300 MMS 200	200	50	241	52	12	250	

MMS
MOBLEN TEKER MASURALI







KOD NO	 mm	 mm	 mm	 mm	 mm	 mm	 kg
3300 MMS 064 F18	64	30	99	41	120	12	80
3300 MMS 080 F18	80	30	106	41	120	12	100
3300 MMS 100 F18	100	30	129	42	120	12	110
3300 MMS 125 F18	125	37.5	155	38	120	12	150
3300 MMS 140 F18	140	37.5	177	38	120	12	160
3300 MMS 150 F18	150	40	181	38	120	12	180
3300 MMS 160 F18	160	40	199	54	150	12	210
3300 MMS 180 F18	180	45	220	55	150	12	230
3300 MMS 200 F18	200	50	241	52	150	12	250

MTB
MOBLEN KASNAK ÜZERİ TERMOELASTİK KAPLAMA BURÇLU







KOD NO	 mm	 mm	 mm	 mm	 mm	 mm	 kg
3300 MTB 080	80	30	106	41	12	12	80
3300 MTB 100	100	30	129	42	12	12	100
3300 MTB 125	125	37.5	155	38	12	12	120
3300 MTB 150	150	40	181	38	12	12	130

* 150'LİK RULETİMİZDE SIRT KAPLAMASI İNCEDİR.

MTB
MOBLEN KASNAK ÜZERİ TERMOELASTİK KAPLAMA BURÇLU







KOD NO	 mm	 mm	 mm	 mm	 mm	 mm	 kg
3300 MTB 080 F18	80	30	106	41	120	12	80
3300 MTB 100 F18	100	30	129	42	120	12	100
3300 MTB 125 F18	125	37.5	155	38	120	12	120
3300 MTB 150 F18	150	40	181	38	120	12	130

MTS
MOBLEN KASNAK ÜZERİ TERMOELASTİK KAPLAMA MASURALI







KOD NO	 mm	 mm	 mm	 mm	 mm	 mm	 kg
3300 MTS 080	80	30	106	41	12	12	80
3300 MTS 100	100	30	129	42	12	12	100
3300 MTS 125	125	37.5	155	38	12	12	120
3300 MTS 150	150	40	181	38	12	12	130

* 150'LİK RULETİMİZDE SIRT KAPLAMASI İNCEDİR.







MTS
MOBLEN KASNAK ÜZERİ TERMOELASTİK KAPLAMA MASURALI

KOD NO	 mm	 mm	 mm	 mm	 mm	 mm	 kg
3300 MTS 080 F18	80	30	106	41	120	12	80
3300 MTS 100 F18	100	30	129	42	120	12	100
3300 MTS 125 F18	125	37.5	155	38	120	12	120
3300 MTS 150 F18	150	40	181	38	120	12	130









PPB		POLİAMİD TEKER BURÇLU					
KOD NO	 mm	 mm	 mm	 mm	 mm	 kg	
3300 PPB 064	64	30	99	41	12	120	
3300 PPB 080	80	30	106	41	12	120	
3300 PPB 100	100	30	129	42	12	130	
3300 PPB 125	125	37.5	155	38	12	170	
3300 PPB 140	140	37.5	177	38	12	180	
3300 PPB 150	150	40	181	38	12	200	
3300 PPB 160	160	40	199	54	12	240	
3300 PPB 180	180	45	220	55	12	260	
3300 PPB 200	200	50	241	52	12	290	









PPB		POLİAMİD TEKER BURÇLU					
KOD NO	 mm	 mm	 mm	 mm	 mm	 kg	
3300 PPB 064 F18	64	30	99	41	120	120	
3300 PPB 080 F18	80	30	106	41	120	120	
3300 PPB 100 F18	100	30	129	42	120	130	
3300 PPB 125 F18	125	37.5	155	38	120	170	
3300 PPB 140 F18	140	37.5	177	38	120	180	
3300 PPB 150 F18	150	40	181	38	120	200	
3300 PPB 160 F18	160	40	199	54	150	240	
3300 PPB 180 F18	180	45	220	55	150	260	
3300 PPB 200 F18	200	50	241	52	150	290	



PPS		POLİAMİD TEKER MASURALI					
KOD NO	 mm	 mm	 mm	 mm	 mm	 kg	
3300 PPS 080	80	30	106	41	12	120	
3300 PPS 100	100	30	129	42	12	130	
3300 PPS 125	125	37.5	155	38	12	170	
3300 PPS 140	140	37.5	177	38	12	180	
3300 PPS 150	150	40	181	38	12	200	
3300 PPS 160	160	40	199	54	12	240	
3300 PPS 180	180	45	220	55	12	260	
3300 PPS 200	200	50	241	52	12	290	







PPS		POLİAMİD TEKER MASURALI					
KOD NO	 mm	 mm	 mm	 mm	 mm	 mm	 kg
3300 PPS 080 F18	80	30	106	41	120	12	120
3300 PPS 100 F18	100	30	129	42	120	12	130
3300 PPS 125 F18	125	37.5	155	38	120	12	170
3300 PPS 140 F18	140	37.5	177	38	120	12	180
3300 PPS 150 F18	150	40	181	38	120	12	200
3300 PPS 160 F18	160	40	199	54	150	12	240
3300 PPS 180 F18	180	45	220	55	150	12	260
3300 PPS 200 F18	200	50	241	52	150	12	290









SSS		GALVANİZ KAPLI SAC ÜZERİ SİYAH VEYA GRİ DUBLEKS LASTİK KAPLAMA MASURALI					
KOD NO	 mm	 mm	 mm	 mm	 mm	 mm	 kg
3300 SSS 200	200	50	241	52	12		150









SSS		GALVANİZ KAPLI SAC ÜZERİ SİYAH VEYA GRİ DUBLEKS LASTİK KAPLAMA MASURALI					
KOD NO	 mm	 mm	 mm	 mm	 mm	 mm	 kg
3300 SSS 200 F18	200	50	241	52	150	12	150









CTB		GÜÇLENDİRİLMİŞ POLİAMİD KASNAK ÜZERİ TERMOELASTİK KAPLAMA BURÇLU					
KOD NO	 mm	 mm	 mm	 mm	 mm	 mm	 kg
3300 CTB 200	200	50	241	52	12		250









CTB		GÜÇLENDİRİLMİŞ POLİAMİD KASNAK ÜZERİ TERMOELASTİK KAPLAMA BURÇLU					
KOD NO	 mm	 mm	 mm	 mm	 mm	 mm	 kg
3300 CTB 200 F18	200	50	241	52	150	12	250



CTR		GÜÇLENDİRİLMİŞ POLİAMİD KASNAK ÜZERİ TERMOELASTİK KAPLAMA RULMANLI					
KOD NO							
	mm	mm	mm	mm	mm	kg	
3300 CTR 200	200	50	241	52	12	250	



CTR		GÜÇLENDİRİLMİŞ POLİAMİD KASNAK ÜZERİ TERMOELASTİK KAPLAMA RULMANLI					
KOD NO							
	mm	mm	mm	mm	mm	mm	kg
3300 CTR 200 F18	200	50	241	52	150	12	250



PYB		POLİAMİD KASNAK ÜZERİ AĞIR TİP VULKANİZE SİYAH LASTİK KAPLAMA BURÇLU					
KOD NO							
	mm	mm	mm	mm	mm	kg	
3300 PYB 200	200	50	241	52	12	250	



PYB		POLİAMİD KASNAK ÜZERİ AĞIR TİP VULKANİZE SİYAH LASTİK KAPLAMA BURÇLU					
KOD NO							
	mm	mm	mm	mm	mm	mm	kg
3300 PYB 200 F18	200	50	241	52	150	12	250









PYR		POLİAMİD KASNAK ÜZERİ AĞIR TİP VULKANİZE SİYAH LASTİK KAPLAMA RULMANLI					
KOD NO							
	mm	mm	mm	mm	mm	kg	
3300 PYR 200	200	50	241	52	12	250	









PYR		POLİAMİD KASNAK ÜZERİ AĞIR TİP VULKANİZE SİYAH LASTİK KAPLAMA RULMANLI					
KOD NO							
	mm	mm	mm	mm	mm	mm	kg
3300 PYR 200 F18	200	50	241	52	150	12	250



RMB		AĞIR TİP MOBLEN KASNAK ÜZERİ MOBLEN KAPLAMA BURÇLU					
KOD NO	 mm	 mm	 mm	 mm	 mm	 kg	
3300 RMB 200	200	50	241	52	12	280	



RMB		AĞIR TİP MOBLEN KASNAK ÜZERİ MOBLEN KAPLAMA BURÇLU					
KOD NO	 mm	 mm	 mm	 mm	 mm	 mm	 kg
3300 RMB 200 F18	200	50	241	52	150	12	280



RPB		AĞIR TİP POLİAMİD KASNAK ÜZERİ POLİAMİD KAPLAMA BURÇLU					
KOD NO	 mm	 mm	 mm	 mm	 mm	 kg	
3300 RPB 200	200	50	241	52	12	400	



RPB		AĞIR TİP POLİAMİD KASNAK ÜZERİ POLİAMİD KAPLAMA BURÇLU					
KOD NO	 mm	 mm	 mm	 mm	 mm	 mm	 kg
3300 RPB 200 F18	200	50	241	52	150	12	400









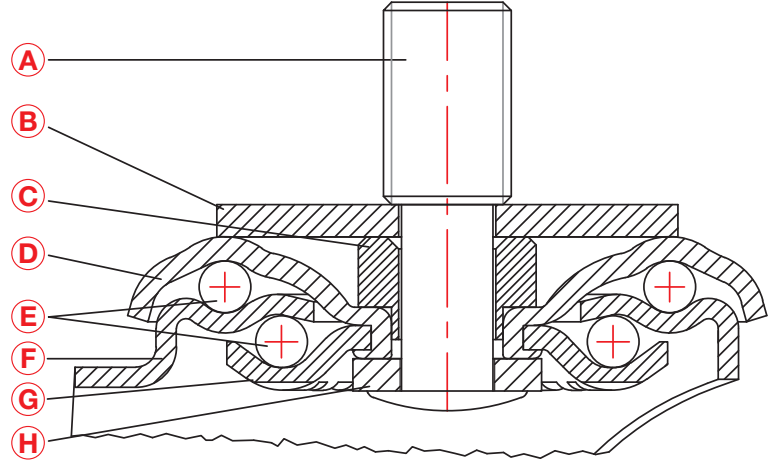

RPR		AĞIR TİP POLİAMİD KASNAK ÜZERİ POLİAMİD KAPLAMA RULMANLI					
KOD NO	 mm	 mm	 mm	 mm	 mm	 kg	
3300 RPR 200	200	50	241	52	12	400	



RPR		AĞIR TİP POLİAMİD KASNAK ÜZERİ POLİAMİD KAPLAMA RULMANLI					
KOD NO	 mm	 mm	 mm	 mm	 mm	 mm	 kg
3300 RPR 200 F18	200	50	241	52	150	12	400

- A:** BAĞLANTI CİVATASI
B: ALTİGEN PUL
C: KISA BORU PERÇİNİ
D: ÜST BİLYA KAPAĞI
E: KÜRESEL METAL TANE BİLYALAR
F: OYNAK RULET MAŞASI
G: ALT BİLYA ÇANAĞI
H: MONTAJ PULU









PRS		POLİAMİD KASNAK ÜZERİ MAVİ KAUÇUK LASTİK KAPLAMA MASURALI					
KOD NO	 mm	 mm	 mm	 mm	 mm	 mm	 kg
3301 PRS 080	80	32	110	41	M12,M16,5/8"	25	80
3301 PRS 100	100	36	133	42	M12,M16,5/8"	25	120
3301 PRS 125	125	40	159	38	M12,M16,5/8"	25	150
3301 PRS 150	150	40	185	38	M12,M16,5/8"	25	200









PRS		POLİAMİD KASNAK ÜZERİ MAVİ KAUÇUK LASTİK KAPLAMA MASURALI						
KOD NO	 mm	 mm	 mm	 mm	 mm	 mm	 kg	
3301 PRS 080 F18	80	32	110	41	120	M12,M16,5/8"	25	80
3301 PRS 100 F18	100	36	133	42	120	M12,M16,5/8"	25	120
3301 PRS 125 F18	125	40	159	38	120	M12,M16,5/8"	25	150
3301 PRS 150 F18	150	40	185	38	120	M12,M16,5/8"	25	200









PUB		POLİAMİD KASNAK ÜZERİ POLİÜRETAN KAPLAMA BURÇLU					
KOD NO	 mm	 mm	 mm	 mm	 mm	 mm	 kg
3301 PUB 080	80	30	110	41	M12,M16,5/8"	25	125
3301 PUB 100	100	30	133	42	M12,M16,5/8"	25	150
3301 PUB 125	125	37.5	159	38	M12,M16,5/8"	25	180









PUB		POLİAMİD KASNAK ÜZERİ POLİÜRETAN KAPLAMA BURÇLU						
KOD NO								
	mm	mm	mm	mm	mm	mm	kg	
3301 PUB 150	150	40	185	38	M12,M16,5/8"	25	260	
3301 PUB 200	200	50	242	52	M16,5/8"	25	400	







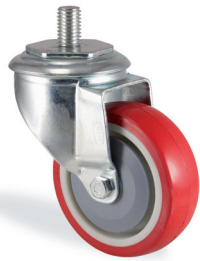

PUB		POLİAMİD KASNAK ÜZERİ POLİÜRETAN KAPLAMA BURÇLU						
KOD NO								
	mm	mm	mm	mm	mm	mm	kg	
3301 PUB 080 F18	80	30	110	41	120	M12,M16,5/8"	125	
3301 PUB 100 F18	100	30	133	42	120	M12,M16,5/8"	150	
3301 PUB 125 F18	125	37.5	159	38	120	M12,M16,5/8"	180	









PUB		POLİAMİD KASNAK ÜZERİ POLİÜRETAN KAPLAMA BURÇLU						
KOD NO								
	mm	mm	mm	mm	mm	mm	kg	
3301 PUB 150 F18	150	40	185	38	120	M12,M16,5/8"	260	
3301 PUB 200 F18	200	50	242	52	150	M16,5/8"	400	











PUR		POLİAMİD KASNAK ÜZERİ POLİÜRETAN KAPLAMA RULMANLI						
KOD NO								
	mm	mm	mm	mm	mm	mm	kg	
3301 PUR 080	80	32	110	41	M12,M16,5/8"	25	125	
3301 PUR 100	100	32	133	42	M12,M16,5/8"	25	150	
3301 PUR 125	125	32	159	38	M12,M16,5/8"	25	180	











PUR		POLİAMİD KASNAK ÜZERİ POLİÜRETAN KAPLAMA RULMANLI						
KOD NO								
	mm	mm	mm	mm	mm	mm	kg	
3301 PUR 200	200	50	242	52	M16,5/8"	25	400	











PUR		POLİAMİD KASNAK ÜZERİ POLİÜRETAN KAPLAMA RULMANLI							
KOD NO									
	mm	mm	mm	mm	mm	mm	mm	kg	
3301 PUR 080 F18	80	32	110	41	120	M12,M16,5/8"	25	125	
3301 PUR 100 F18	100	32	133	42	120	M12,M16,5/8"	25	150	
3301 PUR 125 F18	125	32	159	38	120	M12,M16,5/8"	25	180	











PUR		POLİAMİD KASNAK ÜZERİ POLİÜRETAN KAPLAMA RULMANLI							
KOD NO									
	mm	mm	mm	mm	mm	mm	mm	kg	
3301 PUR 200 F18	200	50	242	52	150	M16,5/8"	25	400	











PUS		POLİAMİD KASNAK ÜZERİ POLİÜRETAN KAPLAMA MASURALI							
KOD NO									
	mm	mm	mm	mm	mm	mm	mm	kg	
3301 PUS 080	80	30	110	41	M12,M16,5/8"	25	125		
3301 PUS 100	100	30	133	42	M12,M16,5/8"	25	150		
3301 PUS 125	125	37.5	159	38	M12,M16,5/8"	25	180		











PUS		POLİAMİD KASNAK ÜZERİ POLİÜRETAN KAPLAMA MASURALI							
KOD NO									
	mm	mm	mm	mm	mm	mm	mm	kg	
3301 PUS 150	150	40	185	38	M12,M16,5/8"	25	260		
3301 PUS 200	200	50	242	52	M16,5/8"	25	400		











PUS		POLİAMİD KASNAK ÜZERİ POLİÜRETAN KAPLAMA MASURALI							
KOD NO									
	mm	mm	mm	mm	mm	mm	mm	kg	
3301 PUS 080 F18	80	30	110	41	120	M12,M16,5/8"	25	125	
3301 PUS 100 F18	100	30	133	42	120	M12,M16,5/8"	25	150	
3301 PUS 125 F18	125	37.5	159	38	120	M12,M16,5/8"	25	180	









PUS POLİAMİD KASNAK ÜZERİ POLİÜRETAN KAPLAMA MASURALI

KOD NO	 mm	 mm	 mm	 mm	 mm	 mm	 mm	 kg
3301 PUS 150 F18	150	40	185	38	120	M12,M16,5/8"	25	260
3301 PUS 200 F18	200	50	242	52	150	M16,5/8"	25	400









SLP GALVANİZ KAPLI SAC ÜZERİ SİYAH KAUÇUK LASTİK KAPLAMA POLİAMİD BURÇLU

KOD NO	 mm	 mm	 mm	 mm	 mm	 mm	 mm	 kg
3301 SLP 080	80	25	110	41	M12,M16,5/8"	25	50	50
3301 SLP 100	100	30	133	42	M12,M16,5/8"	25	70	70
3301 SLP 125	125	37.5	159	38	M12,M16,5/8"	25	100	100
3301 SLP 140	140	37.5	182	38	M12,M16,5/8"	25	115	115
3301 SLP 150	150	38	185	38	M12,M16,5/8"	25	125	125
3301 SLP 160	160	38	204	54	M16,5/8"	25	135	135
3301 SLP 180	180	45	225	55	M16,5/8"	25	170	170
3301 SLP 200	200	50	242	52	M16,5/8"	25	205	205

SLP GALVANİZ KAPLI SAC ÜZERİ SİYAH KAUÇUK LASTİK KAPLAMA POLİAMİD BURÇLU

KOD NO	 mm	 mm	 mm	 mm	 mm	 mm	 mm	 kg
3301 SLP 080 F18	80	25	110	41	120	M12,M16,5/8"	25	50
3301 SLP 100 F18	100	30	133	42	120	M12,M16,5/8"	25	70
3301 SLP 125 F18	125	37.5	159	38	120	M12,M16,5/8"	25	100
3301 SLP 140 F18	140	37.5	182	38	120	M12,M16,5/8"	25	115
3301 SLP 150 F18	150	38	185	38	120	M12,M16,5/8"	25	125
3301 SLP 160 F18	160	38	204	54	150	M16,5/8"	25	135
3301 SLP 180 F18	180	45	225	55	150	M16,5/8"	25	170
3301 SLP 200 F18	200	50	242	52	150	M16,5/8"	25	205

SLS GALVANİZ KAPLI SAC ÜZERİ SİYAH KAUÇUK LASTİK KAPLAMA MASURALI

KOD NO	 mm	 mm	 mm	 mm	 mm	 mm	 mm	 kg
3301 SLS 080	80	25	110	41	M12,M16,5/8"	25	50	50
3301 SLS 100	100	30	133	42	M12,M16,5/8"	25	70	70
3301 SLS 125	125	37.5	159	38	M12,M16,5/8"	25	100	100
3301 SLS 140	140	37.5	182	38	M12,M16,5/8"	25	115	115
3301 SLS 150	150	38	185	38	M12,M16,5/8"	25	125	125
3301 SLS 160	160	38	204	54	M16,5/8"	25	135	135
3301 SLS 180	180	45	225	55	M16,5/8"	25	170	170
3301 SLS 200	200	50	242	52	M16,5/8"	25	205	205



SLS		GALVANİZ KAPLI SAC ÜZERİ SİYAH KAUÇUK LASTİK KAPLAMA MASURALI						
KOD NO	 mm	 mm	 mm	 mm	 mm	 mm	 mm	 kg
3301 SLS 080 F18	80	25	110	41	120	M12,M16,5/8"	25	50
3301 SLS 100 F18	100	30	133	42	120	M12,M16,5/8"	25	70
3301 SLS 125 F18	125	37.5	159	38	120	M12,M16,5/8"	25	100
3301 SLS 140 F18	140	37.5	182	38	120	M12,M16,5/8"	25	115
3301 SLS 150 F18	150	38	185	38	120	M12,M16,5/8"	25	125
3301 SLS 160 F18	160	38	204	54	150	M16,5/8"	25	135
3301 SLS 180 F18	180	45	225	55	150	M16,5/8"	25	170
3301 SLS 200 F18	200	50	242	52	150	M16,5/8"	25	205



SES		GALVANİZ KAPLI SAC ÜZERİ GRİ KAUÇUK LASTİK KAPLAMA MASURALI						
KOD NO	 mm	 mm	 mm	 mm	 mm	 mm	 mm	 kg
3301 SES 080	80	25	110	41	M12,M16,5/8"	25	50	
3301 SES 100	100	30	133	42	M12,M16,5/8"	25	70	
3301 SES 125	125	37.5	159	38	M12,M16,5/8"	25	100	
3301 SES 140	140	37.5	182	38	M12,M16,5/8"	25	115	
3301 SES 150	150	38	185	38	M12,M16,5/8"	25	125	
3301 SES 160	160	38	204	54	M16,5/8"	25	135	
3301 SES 180	180	45	225	55	M16,5/8"	25	170	
3301 SES 200	200	50	242	52	M16,5/8"	25	205	



SES		GALVANİZ KAPLI SAC ÜZERİ GRİ KAUÇUK LASTİK KAPLAMA MASURALI						
KOD NO	 mm	 mm	 mm	 mm	 mm	 mm	 mm	 kg
3301 SES 080 F18	80	25	110	41	120	M12,M16,5/8"	25	50
3301 SES 100 F18	100	30	133	42	120	M12,M16,5/8"	25	70
3301 SES 125 F18	125	37.5	159	38	120	M12,M16,5/8"	25	100
3301 SES 140 F18	140	37.5	182	38	120	M12,M16,5/8"	25	115
3301 SES 150 F18	150	38	185	38	120	M12,M16,5/8"	25	125
3301 SES 160 F18	160	38	204	54	150	M16,5/8"	25	135
3301 SES 180 F18	180	45	225	55	150	M16,5/8"	25	170
3301 SES 200 F18	200	50	242	52	150	M16,5/8"	25	205



MLB		MOBLEN KASNAK ÜZERİ SİYAH DOLGU LASTİK KAPLAMA BURÇLU						
KOD NO								
	mm	mm	mm	mm	mm	mm	kg	
3301 MLB 080	80	25	110	41	M12,M16,5/8"	25	50	
3301 MLB 100	100	30	133	42	M12,M16,5/8"	25	70	
3301 MLB 125	125	37.5	159	38	M12,M16,5/8"	25	100	
3301 MLB 140	140	37.5	182	38	M12,M16,5/8"	25	115	
3301 MLB 150	150	40	185	38	M12,M16,5/8"	25	125	
3301 MLB 160	160	40	204	54	M16,5/8"	25	135	
3301 MLB 180	180	45	225	55	M16,5/8"	25	170	
3301 MLB 200	200	50	242	52	M16,5/8"	25	220	



MLB		MOBLEN KASNAK ÜZERİ SİYAH DOLGU LASTİK KAPLAMA BURÇLU						
KOD NO								
	mm	mm	mm	mm	mm	mm	mm	kg
3301 MLB 080 F18	80	25	110	41	120	M12,M16,5/8"	25	50
3301 MLB 100 F18	100	30	133	42	120	M12,M16,5/8"	25	70
3301 MLB 125 F18	125	37.5	159	38	120	M12,M16,5/8"	25	100
3301 MLB 140 F18	140	37.5	182	38	120	M12,M16,5/8"	25	115
3301 MLB 150 F18	150	40	185	38	120	M12,M16,5/8"	25	125
3301 MLB 160 F18	160	40	204	54	150	M16,5/8"	25	135
3301 MLB 180 F18	180	45	225	55	150	M16,5/8"	25	170
3301 MLB 200 F18	200	50	242	52	150	M16,5/8"	25	220



MLS		MOBLEN KASNAK ÜZERİ SİYAH DOLGU LASTİK KAPLAMA MASURALI						
KOD NO								
	mm	mm	mm	mm	mm	mm	kg	
3301 MLS 080	80	30	110	41	M12,M16,5/8"	25	50	
3301 MLS 100	100	30	133	42	M12,M16,5/8"	25	70	
3301 MLS 125	125	37.5	159	38	M12,M16,5/8"	25	100	
3301 MLS 140	140	37.5	182	38	M12,M16,5/8"	25	115	
3301 MLS 150	150	40	185	38	M12,M16,5/8"	25	125	
3301 MLS 160	160	40	204	54	M16,5/8"	25	135	
3301 MLS 180	180	45	225	55	M16,5/8"	25	170	
3301 MLS 200	200	50	242	52	M16,5/8"	25	220	



MLS		MOBLEN KASNAK ÜZERİ SİYAH DOLGU LASTİK KAPLAMA MASURALI						
KOD NO	mm	mm	mm	mm	mm	mm	mm	kg
3301 MLS 080 F18	80	30	110	41	120	M12,M16,5/8"	25	50
3301 MLS 100 F18	100	30	133	42	120	M12,M16,5/8"	25	70
3301 MLS 125 F18	125	37.5	159	38	120	M12,M16,5/8"	25	100
3301 MLS 140 F18	140	37.5	182	38	120	M12,M16,5/8"	25	115
3301 MLS 150 F18	150	40	185	38	120	M12,M16,5/8"	25	125
3301 MLS 160 F18	160	40	204	54	150	M16,5/8"	25	135
3301 MLS 180 F18	180	45	225	55	150	M16,5/8"	25	170
3301 MLS 200 F18	200	50	242	52	150	M16,5/8"	25	220



MES		MOBLEN KASNAK ÜZERİ GRİ DOLGU LASTİK KAPLAMA MASURALI						
KOD NO	mm	mm	mm	mm	mm	mm	mm	kg
3301 MES 080	80	30	110	41	M12,M16,5/8"	25	50	
3301 MES 100	100	30	133	42	M12,M16,5/8"	25	70	
3301 MES 125	125	37.5	159	38	M12,M16,5/8"	25	100	
3301 MES 140	140	37.5	182	38	M12,M16,5/8"	25	115	
3301 MES 150	150	40	185	38	M12,M16,5/8"	25	125	
3301 MES 160	160	40	204	54	M16,5/8"	25	135	
3301 MES 180	180	45	225	55	M16,5/8"	25	170	
3301 MES 200	200	50	242	52	M16,5/8"	25	220	



MES		MOBLEN KASNAK ÜZERİ GRİ DOLGU LASTİK KAPLAMA MASURALI						
KOD NO	mm	mm	mm	mm	mm	mm	mm	kg
3301 MES 080 F18	80	30	110	41	120	M12,M16,5/8"	25	50
3301 MES 100 F18	100	30	133	42	120	M12,M16,5/8"	25	70
3301 MES 125 F18	125	37.5	159	38	120	M12,M16,5/8"	25	100
3301 MES 140 F18	140	37.5	182	38	120	M12,M16,5/8"	25	115
3301 MES 150 F18	150	40	185	38	120	M12,M16,5/8"	25	125
3301 MES 160 F18	160	40	204	54	150	M16,5/8"	25	135
3301 MES 180 F18	180	45	225	55	150	M16,5/8"	25	170
3301 MES 200 F18	200	50	242	52	150	M16,5/8"	25	220

MMB
MOBLEN TEKER BURÇLU

KOD NO	mm	mm	mm	mm	mm	mm	kg
3301 MMB 064	64	30	105	41	M12,M16,5/8"	25	80
3301 MMB 080	80	30	110	41	M12,M16,5/8"	25	100
3301 MMB 100	100	30	133	42	M12,M16,5/8"	25	110
3301 MMB 125	125	37.5	159	38	M12,M16,5/8"	25	150
3301 MMB 140	140	37.5	182	38	M12,M16,5/8"	25	160
3301 MMB 150	150	40	185	38	M12,M16,5/8"	25	180
3301 MMB 160	160	40	204	54	M16,5/8"	25	210
3301 MMB 180	180	45	225	55	M16,5/8"	25	230
3301 MMB 200	200	50	242	52	M16,5/8"	25	250









MMB
MOBLEN TEKER BURÇLU

KOD NO	mm	mm	mm	mm	mm	mm	mm	kg
3301 MMB 064 F18	64	30	105	41	120	M12,M16,5/8"	25	80
3301 MMB 080 F18	80	30	110	41	120	M12,M16,5/8"	25	100
3301 MMB 100 F18	100	30	133	42	120	M12,M16,5/8"	25	110
3301 MMB 125 F18	125	37.5	159	38	120	M12,M16,5/8"	25	150
3301 MMB 140 F18	140	37.5	182	38	120	M12,M16,5/8"	25	160
3301 MMB 150 F18	150	40	185	38	120	M12,M16,5/8"	25	180
3301 MMB 160 F18	160	40	204	54	150	M16,5/8"	25	210
3301 MMB 180 F18	180	45	225	55	150	M16,5/8"	25	230
3301 MMB 200 F18	200	50	242	52	150	M16,5/8"	25	250









MMS
MOBLEN TEKER MASURALI

KOD NO	mm	mm	mm	mm	mm	mm	mm	kg
3301 MMS 064	64	30	105	41	M12,M16,5/8"	25	80	
3301 MMS 080	80	30	110	41	M12,M16,5/8"	25	100	
3301 MMS 100	100	30	133	42	M12,M16,5/8"	25	110	
3301 MMS 125	125	37.5	159	38	M12,M16,5/8"	25	150	
3301 MMS 140	140	37.5	182	38	M12,M16,5/8"	25	160	
3301 MMS 150	150	40	185	38	M12,M16,5/8"	25	180	
3301 MMS 160	160	40	204	54	M16,5/8"	25	210	
3301 MMS 180	180	45	225	55	M16,5/8"	25	230	
3301 MMS 200	200	50	242	52	M16,5/8"	25	250	

MMS
MOBLEN TEKER MASURALI







KOD NO								kg
3301 MMS 064 F18	64	30	105	41	120	M12,M16,5/8"	25	80
3301 MMS 080 F18	80	30	110	41	120	M12,M16,5/8"	25	100
3301 MMS 100 F18	100	30	133	42	120	M12,M16,5/8"	25	110
3301 MMS 125 F18	125	37.5	159	38	120	M12,M16,5/8"	25	150
3301 MMS 140 F18	140	37.5	182	38	120	M12,M16,5/8"	25	160
3301 MMS 150 F18	150	40	185	38	120	M12,M16,5/8"	25	180
3301 MMS 160 F18	160	40	204	54	150	M16,5/8"	25	210
3301 MMS 180 F18	180	45	225	55	150	M16,5/8"	25	230
3301 MMS 200 F18	200	50	242	52	150	M16,5/8"	25	250

MTB
MOBLEN KASNAK ÜZERİ TERMOELASTİK KAPLAMA BURÇLU







KOD NO								kg
3301 MTB 080	80	30	110	41	M12,M16,5/8"	25	80	
3301 MTB 100	100	30	133	42	M12,M16,5/8"	25	100	
3301 MTB 125	125	37.5	159	38	M12,M16,5/8"	25	120	
3301 MTB 150	150	40	185	38	M12,M16,5/8"	25	130	

* 150'LİK RULETİMİZDE SIRT KAPLAMASI İNCE DİR.

MTB
MOBLEN KASNAK ÜZERİ TERMOELASTİK KAPLAMA BURÇLU







KOD NO								kg
3301 MTB 080 F18	80	30	110	41	120	M12,M16,5/8"	25	80
3301 MTB 100 F18	100	30	133	42	120	M12,M16,5/8"	25	100
3301 MTB 125 F18	125	37.5	159	38	120	M12,M16,5/8"	25	120
3301 MTB 150 F18	150	40	185	38	120	M12,M16,5/8"	25	130

MTS
MOBLEN KASNAK ÜZERİ TERMOELASTİK KAPLAMA MASURALI

KOD NO								kg
3301 MTS 080	80	30	110	41	M12,M16,5/8"	25	80	
3301 MTS 100	100	30	133	42	M12,M16,5/8"	25	100	
3301 MTS 125	125	37.5	159	38	M12,M16,5/8"	25	120	
3301 MTS 150	150	40	185	38	M12,M16,5/8"	25	130	

* 150'LİK RULETİMİZDE SIRT KAPLAMASI İNCE DİR.

MTS
MOBLEN KASNAK ÜZERİ TERMOELASTİK KAPLAMA MASURALI

KOD NO								kg
3301 MTS 080 F18	80	30	110	41	120	M12,M16,5/8"	25	80
3301 MTS 100 F18	100	30	133	42	120	M12,M16,5/8"	25	100
3301 MTS 125 F18	125	37.5	159	38	120	M12,M16,5/8"	25	120
3301 MTS 150 F18	150	40	185	38	120	M12,M16,5/8"	25	130



CTR		GÜÇLENDİRİLMİŞ POLİAMİD KASNAK ÜZERİ TERMOELASTİK KAPLAMA RULMANLI						
KOD NO								
	mm	mm	mm	mm	mm	mm	mm	kg
3301 CTR 200	200	50	242	52	M16,5/8"	25		250



CTR		GÜÇLENDİRİLMİŞ POLİAMİD KASNAK ÜZERİ TERMOELASTİK KAPLAMA RULMANLI						
KOD NO								
	mm	mm	mm	mm	mm	mm	mm	kg
3301 CTR 200 F18	200	50	242	52	150	M16,5/8"	25	250



PYB		POLİAMİD KASNAK ÜZERİ AĞIR TİP VULKANİZE SİYAH LASTİK KAPLAMA BURÇLU						
KOD NO								
	mm	mm	mm	mm	mm	mm	mm	kg
3301 PYB 200	200	50	242	52	M16,5/8"	25		250



PYB		POLİAMİD KASNAK ÜZERİ AĞIR TİP VULKANİZE SİYAH LASTİK KAPLAMA BURÇLU						
KOD NO								
	mm	mm	mm	mm	mm	mm	mm	kg
3301 PYB 200 F18	200	50	242	52	150	M16,5/8"	25	250









PYR		POLİAMİD KASNAK ÜZERİ AĞIR TİP VULKANİZE SİYAH LASTİK KAPLAMA RULMANLI						
KOD NO								
	mm	mm	mm	mm	mm	mm	mm	kg
3301 PYR 200	200	50	242	52	M16,5/8"	25		250











PYR		POLİAMİD KASNAK ÜZERİ AĞIR TİP VULKANİZE SİYAH LASTİK KAPLAMA RULMANLI						
KOD NO								
	mm	mm	mm	mm	mm	mm	mm	kg
3301 PYR 200 F18	200	50	242	52	150	M16,5/8"	25	250









RMB		AĞIR TİP MOBLEN TEKER BURÇLU						
KOD NO								
	mm	mm	mm	mm	mm	mm	kg	
3301 RMB 200	200	50	242	52	M16,5/8"	25	280	











RMB		AĞIR TİP MOBLEN TEKER BURÇLU						
KOD NO								
	mm	mm	mm	mm	mm	mm	mm	kg
3301 RMB 200 F18	200	50	242	52	150	M16,5/8"	25	280









RPB		AĞIR TİP POLİAMİD TEKER BURÇLU						
KOD NO								
	mm	mm	mm	mm	mm	mm	kg	
3301 RPB 200	200	50	242	52	M16,5/8"	25	400	











RPB		AĞIR TİP POLİAMİD TEKER BURÇLU						
KOD NO								
	mm	mm	mm	mm	mm	mm	mm	kg
3301 RPB 200 F18	200	50	242	52	150	M16,5/8"	25	400



RPR		AĞIR TİP POLİAMİD TEKER RULMANLI						
KOD NO								
	mm	mm	mm	mm	mm	mm	kg	
3301 RPR 200	200	50	242	52	M16,5/8"	25	400	



RPR		AĞIR TİP POLİAMİD TEKER RULMANLI						
KOD NO	 mm	 mm	 mm	 mm	 mm	 mm	 mm	 kg
3301 RPR 200 F18	200	50	242	52	150	M16,5/8"	25	400

- A:** OYNAK BAĞLANTI TABLASI
B: BİLYA MUHAFAZA TOZLUĞU
C: KÜRESEL METAL TANE BİLYALAR
D: OYNAK RULET MAŞASI
E: ALT BİLYA ÇANAĞI
F: TABLA PERÇİNİ
G: MONTAJ PULU

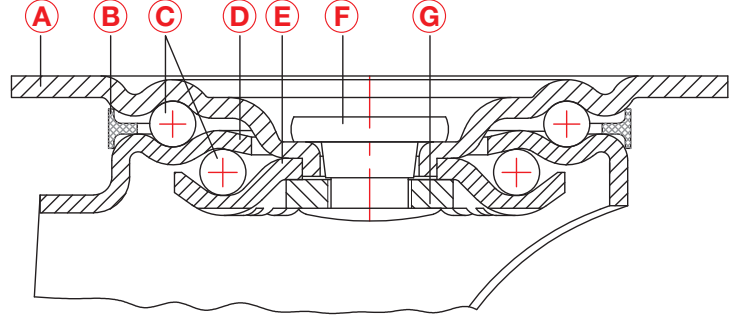



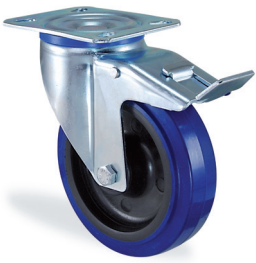





PRS		POLİAMİD KASNAK ÜZERİ MAVİ KAUKÇUK LASTİK KAPLAMA MASURALI						
KOD NO	 mm	 mm	 mm	 mm	 mm	 mm	 mm	 kg
3302 PRS 080	80	32	107	41	100x85	80x60	17x9	80
3302 PRS 100	100	36	130	42	100x85	80x60	17x9	120
3302 PRS 125	125	40	156	38	100x85	80x60	17x9	150
3302 PRS 150	150	40	182	38	100x85	80x60	17x9	200



PRS		POLİAMİD KASNAK ÜZERİ MAVİ KAUKÇUK LASTİK KAPLAMA MASURALI							
KOD NO	 mm	 mm	 mm	 mm	 mm	 mm	 mm	 kg	
3302 PRS 080 F18	80	32	107	41	120	100x85	80x60	17x9	80
3302 PRS 100 F18	100	36	130	42	120	100x85	80x60	17x9	120
3302 PRS 125 F18	125	40	156	38	120	100x85	80x60	17x9	150
3302 PRS 150 F18	150	40	182	38	120	100x85	80x60	17x9	200



PUB		POLİAMİD KASNAK ÜZERİ POLİÜRETAN KAPLAMA BURÇLU						
KOD NO	 mm	 mm	 mm	 mm	 mm	 mm	 mm	 kg
3302 PUB 080	80	30	107	41	100x85	80x60	17x9	125
3302 PUB 100	100	30	130	42	100x85	80x60	17x9	150
3302 PUB 125	125	37.5	156	38	100x85	80x60	17x9	180



PUB		POLİAMİD KASNAK ÜZERİ POLİÜRETAN KAPLAMA BURÇLU						
KOD NO								
	mm	mm	mm	mm	mm	mm	mm	kg
3302 PUB 150	150	40	182	38	100x85	105x75-80	13.5x11	260
3302 PUB 200	200	50	238	52	100x85	105x75-80	13.5x11	400



PUB		POLİAMİD KASNAK ÜZERİ POLİÜRETAN KAPLAMA BURÇLU							
KOD NO									
	mm	mm	mm	mm	mm	mm	mm	mm	kg
3302 PUB 080 F18	80	30	107	41	120	100x85	80x60	17x9	125
3302 PUB 100 F18	100	30	130	42	120	100x85	80x60	17x9	150
3302 PUB 125 F18	125	37.5	156	38	120	100x85	80x60	17x9	180



PUB		POLİAMİD KASNAK ÜZERİ POLİÜRETAN KAPLAMA BURÇLU							
KOD NO									
	mm	mm	mm	mm	mm	mm	mm	mm	kg
3302 PUB 150 F18	150	40	182	38	120	100x85	80x60	17x9	260
3302 PUB 200 F18	200	50	238	52	150	140x110	105x75-80	13.5x11	400











PUR		POLİAMİD KASNAK ÜZERİ POLİÜRETAN KAPLAMA RULMANLI							
KOD NO									
	mm	mm	mm	mm	mm	mm	mm	mm	kg
3302 PUR 080	80	32	107	41	100x85	80x60	17x9	125	
3302 PUR 100	100	32	130	42	100x85	80x60	17x9	150	
3302 PUR 125	125	32	156	38	100x85	80x60	17x9	180	











PUR		POLİAMİD KASNAK ÜZERİ POLİÜRETAN KAPLAMA RULMANLI						
KOD NO								
	mm	mm	mm	mm	mm	mm	mm	kg
3302 PUR 200	200	50	238	52	140x110	105x75-80	13.5x11	400











PUS
POLİAMİD KASNAK ÜZERİ POLİÜRETAN KAPLAMA MASURALI

KOD NO	 mm	 mm	 mm	 mm	 mm	 mm	 mm	 mm	 kg
3302 PUS 150 F18	150	40	182	38	120	100x85	80x60	17x9	260
3302 PUS 200 F18	200	50	238	52	150	140x110	105x75-80	13.5x11	400











SLP
GALVANİZ KAPLI SAC ÜZERİ SİYAH KAÜÇÜK LASTİK KAPLAMA POLİAMİD BURÇLU

KOD NO	 mm	 mm	 mm	 mm	 mm	 mm	 mm	 mm	 kg
3302 SLP 080	80	25	108	41	100x85	80x60	17x9	50	
3302 SLP 100	100	30	130	42	100x85	80x60	17x9	70	
3302 SLP 125	125	37.5	156	38	100x85	80x60	17x9	100	
3302 SLP 140	140	37.5	177	38	100x85	80x60	17x9	115	
3302 SLP 150	150	38	182	38	100x85	80x60	17x9	125	
3302 SLP 160	160	38	199	54	140x110	105x75-80	13.5x11	135	
3302 SLP 180	180	45	220	55	140x110	105x75-80	13.5x11	170	
3302 SLP 200	200	50	240	52	140x110	105x75-80	13.5x11	205	
3302 SLP 250	250	60	296	84	187x170	120x132	38.5x17	295	
3302 SLP 280	280	70	311	84	187x170	120x132	38.5x17	350	

SLP
GALVANİZ KAPLI SAC ÜZERİ SİYAH KAÜÇÜK LASTİK KAPLAMA POLİAMİD BURÇLU

KOD NO	 mm	 mm	 mm	 mm	 mm	 mm	 mm	 mm	 kg
3302 SLP 080 F18	80	25	108	41	120	100x85	80x60	17x9	50
3302 SLP 100 F18	100	30	130	42	120	100x85	80x60	17x9	70
3302 SLP 125 F18	125	37.5	156	38	120	100x85	80x60	17x9	100
3302 SLP 140 F18	140	37.5	177	38	120	100x85	80x60	17x9	115
3302 SLP 150 F18	150	38	182	38	120	100x85	80x60	17x9	125
3302 SLP 160 F18	160	38	199	54	150	140x110	105x75-80	13.5x11	135
3302 SLP 180 F18	180	45	220	55	150	140x110	105x75-80	13.5x11	170
3302 SLP 200 F18	200	50	240	52	150	140x110	105x75-80	13.5x11	205

SLP
GALVANİZ KAPLI SAC ÜZERİ SİYAH KAÜÇÜK LASTİK KAPLAMA POLİAMİD BURÇLU

KOD NO	 mm	 mm	 mm	 mm	 mm	 mm	 mm	 mm	 kg
3302 SLP 250 F09	250	60	296	84	146.5	187x170	120x132	38.5x17	295
3302 SLP 280 F09	280	70	311	84	146.5	187x170	120x132	38.5x17	350

**SLS****GALVANİZ KAPLI SAC ÜZERİ SİYAH KAUÇUK LASTİK KAPLAMA MASURALI**

KOD NO	mm	mm	mm	mm	mm	mm	mm	kg
3302 SLS 080	80	25	108	41	100x85	80x60	17x9	50
3302 SLS 100	100	30	130	42	100x85	80x60	17x9	70
3302 SLS 125	125	37.5	156	38	100x85	80x60	17x9	100
3302 SLS 140	140	37.5	177	38	100x85	80x60	17x9	115
3302 SLS 150	150	38	182	38	100x85	80x60	17x9	125
3302 SLS 160	160	38	199	54	140x110	105x75-80	13.5x11	135
3302 SLS 180	180	45	220	55	140x110	105x75-80	13.5x11	170
3302 SLS 200	200	50	240	52	140x110	105x75-80	13.5x11	205
3302 SLS 250	250	60	296	84	187x170	120x132	38.5x17	295
3302 SLS 280	280	70	311	84	187x170	120x132	38.5x17	350









**SLS****GALVANİZ KAPLI SAC ÜZERİ SİYAH KAUÇUK LASTİK KAPLAMA MASURALI**

KOD NO	mm	mm	mm	mm	mm	mm	mm	mm	kg
3302 SLS 080 F18	80	25	108	41	120	100x85	80x60	17x9	50
3302 SLS 100 F18	100	30	130	42	120	100x85	80x60	17x9	70
3302 SLS 125 F18	125	37.5	156	38	120	100x85	80x60	17x9	100
3302 SLS 140 F18	140	37.5	177	38	120	100x85	80x60	17x9	115
3302 SLS 150 F18	150	38	182	38	120	100x85	80x60	17x9	125
3302 SLS 160 F18	160	38	199	54	150	140x110	105x75-80	13.5x11	135
3302 SLS 180 F18	180	45	220	55	150	140x110	105x75-80	13.5x11	170
3302 SLS 200 F18	200	50	240	52	150	140x110	105x75-80	13.5x11	205

**SLS****GALVANİZ KAPLI SAC ÜZERİ SİYAH KAUÇUK LASTİK KAPLAMA MASURALI**

KOD NO	mm	mm	mm	mm	mm	mm	mm	mm	kg
3302 SLS 250 F09	250	60	296	84	146.5	187x170	120x132	38.5x17	295
3302 SLS 280 F09	280	70	311	84	146.5	187x170	120x132	38.5x17	350







SES		GALVANİZ KAPLI SAC ÜZERİ GRİ KAUÇUK LASTİK KAPLAMA MASURALI						
KOD NO								
	mm	mm	mm	mm	mm	mm	mm	kg
3302 SES 080	80	25	108	41	100x85	80x60	17x9	50
3302 SES 100	100	30	130	42	100x85	80x60	17x9	70
3302 SES 125	125	37.5	156	38	100x85	80x60	17x9	100
3302 SES 140	140	37.5	177	38	100x85	80x60	17x9	115
3302 SES 150	150	38	182	38	100x85	80x60	17x9	125
3302 SES 160	160	38	199	54	140x110	105x75-80	13.5x11	135
3302 SES 180	180	45	220	55	140x110	105x75-80	13.5x11	170
3302 SES 200	200	50	240	52	140x110	105x75-80	13.5x11	205
3302 SES 250	250	60	296	84	187x170	120x132	38.5x17	295
3302 SES 280	280	70	311	84	187x170	120x132	38.5x17	350



SES		GALVANİZ KAPLI SAC ÜZERİ GRİ KAUÇUK LASTİK KAPLAMA MASURALI							
KOD NO									
	mm	mm	mm	mm	mm	mm	mm	kg	
3302 SES 080 F18	80	25	108	41	120	100x85	80x60	17x9	50
3302 SES 100 F18	100	30	130	42	120	100x85	80x60	17x9	70
3302 SES 125 F18	125	37.5	156	38	120	100x85	80x60	17x9	100
3302 SES 140 F18	140	37.5	177	38	120	100x85	80x60	17x9	115
3302 SES 150 F18	150	38	182	38	120	100x85	80x60	17x9	125
3302 SES 160 F18	160	38	199	54	150	140x110	105x75-80	13.5x11	135
3302 SES 180 F18	180	45	220	55	150	140x110	105x75-80	13.5x11	170
3302 SES 200 F18	200	50	240	52	150	140x110	105x75-80	13.5x11	205



SES		GALVANİZ KAPLI SAC ÜZERİ GRİ KAUÇUK LASTİK KAPLAMA MASURALI							
KOD NO									
	mm	mm	mm	mm	mm	mm	mm	kg	
3302 SES 250 F09	250	60	296	84	146.5	187x170	120x132	38.5x17	295
3302 SES 280 F09	280	70	311	84	146.5	187x170	120x132	38.5x17	350



MLB		MOBLEN KASNAK ÜZERİ SİYAH DOLGU LASTİK KAPLAMA BURÇLU						
KOD NO								
	mm	mm	mm	mm	mm	mm	mm	kg
3302 MLB 080	80	25	107	41	100x85	80x60	17x9	50
3302 MLB 100	100	30	130	42	100x85	80x60	17x9	70
3302 MLB 125	125	37.5	156	38	100x85	80x60	17x9	100
3302 MLB 140	140	37.5	176	38	100x85	80x60	17x9	115
3302 MLB 150	150	40	182	38	100x85	80x60	17x9	125
3302 MLB 160	160	40	197	54	140x110	105x75-80	13.5x11	135
3302 MLB 180	180	45	218	55	140x110	105x75-80	13.5x11	170
3302 MLB 200	200	50	238	52	140x110	105x75-80	13.5x11	220



MLB		MOBLEN KASNAK ÜZERİ SİYAH DOLGU LASTİK KAPLAMA BURÇLU							
KOD NO									
	mm	mm	mm	mm	mm	mm	mm	kg	
3302 MLB 080 F18	80	25	107	41	120	100x85	80x60	17x9	50
3302 MLB 100 F18	100	30	130	42	120	100x85	80x60	17x9	70
3302 MLB 125 F18	125	37.5	156	38	120	100x85	80x60	17x9	100
3302 MLB 140 F18	140	37.5	176	38	120	100x85	80x60	17x9	115
3302 MLB 150 F18	150	40	182	38	120	100x85	80x60	17x9	125
3302 MLB 160 F18	160	40	197	54	150	140x110	105x75-80	13.5x11	135
3302 MLB 180 F18	180	45	218	55	150	140x110	105x75-80	13.5x11	170
3302 MLB 200 F18	200	50	238	52	150	140x110	105x75-80	13.5x11	220



MLS		MOBLEN KASNAK ÜZERİ SİYAH DOLGU LASTİK KAPLAMA MASURALI						
KOD NO								
	mm	mm	mm	mm	mm	mm	mm	kg
3302 MLS 080	80	30	107	41	100x85	80x60	17x9	50
3302 MLS 100	100	30	130	42	100x85	80x60	17x9	70
3302 MLS 125	125	37.5	156	38	100x85	80x60	17x9	100
3302 MLS 140	140	37.5	176	38	100x85	80x60	17x9	115
3302 MLS 150	150	40	182	38	100x85	80x60	17x9	125
3302 MLS 160	160	40	197	54	140x110	105x75-80	13.5x11	135
3302 MLS 180	180	45	218	55	140x110	105x75-80	13.5x11	170
3302 MLS 200	200	50	238	52	140x110	105x75-80	13.5x11	220



MLS									
MOBLEN KASNAK ÜZERİ SİYAH DOLGU LASTİK KAPLAMA MASURALI									
KOD NO	 mm	 mm	 mm	 mm	 mm	 mm	 mm	 mm	 kg
3302 MLS 080 F18	80	30	107	41	120	100x85	80x60	17x9	50
3302 MLS 100 F18	100	30	130	42	120	100x85	80x60	17x9	70
3302 MLS 125 F18	125	37.5	156	38	120	100x85	80x60	17x9	100
3302 MLS 140 F18	140	37.5	176	38	120	100x85	80x60	17x9	115
3302 MLS 150 F18	150	40	182	38	120	100x85	80x60	17x9	125
3302 MLS 160 F18	160	40	197	54	150	140x110	105x75-80	13.5x11	135
3302 MLS 180 F18	180	45	218	55	150	140x110	105x75-80	13.5x11	170
3302 MLS 200 F18	200	50	238	52	150	140x110	105x75-80	13.5x11	220











MES									
MOBLEN KASNAK ÜZERİ GRİ DOLGU LASTİK KAPLAMA MASURALI									
KOD NO	 mm	 mm	 mm	 mm	 mm	 mm	 mm	 mm	 kg
3302 MES 080	80	30	107	41	120	100x85	80x60	17x9	50
3302 MES 100	100	30	130	42	120	100x85	80x60	17x9	70
3302 MES 125	125	37.5	156	38	120	100x85	80x60	17x9	100
3302 MES 140	140	37.5	176	38	120	100x85	80x60	17x9	115
3302 MES 150	150	40	182	38	120	100x85	80x60	17x9	125
3302 MES 160	160	40	197	54	150	140x110	105x75-80	13.5x11	135
3302 MES 180	180	45	218	55	150	140x110	105x75-80	13.5x11	170
3302 MES 200	200	50	238	52	150	140x110	105x75-80	13.5x11	220











MES									
MOBLEN KASNAK ÜZERİ GRİ DOLGU LASTİK KAPLAMA MASURALI									
KOD NO	 mm	 mm	 mm	 mm	 mm	 mm	 mm	 mm	 kg
3302 MES 080 F18	80	30	107	41	120	100x85	80x60	17x9	50
3302 MES 100 F18	100	30	130	42	120	100x85	80x60	17x9	70
3302 MES 125 F18	125	37.5	156	38	120	100x85	80x60	17x9	100
3302 MES 140 F18	140	37.5	176	38	120	100x85	80x60	17x9	115
3302 MES 150 F18	150	40	182	38	120	100x85	80x60	17x9	125
3302 MES 160 F18	160	40	197	54	150	140x110	105x75-80	13.5x11	135
3302 MES 180 F18	180	45	218	55	150	140x110	105x75-80	13.5x11	170
3302 MES 200 F18	200	50	238	52	150	140x110	105x75-80	13.5x11	220









MMB
MOBLEN TEKER BURÇLU

KOD NO	 mm	 mm	 mm	 mm	 mm	 mm	 mm	 kg
3302 MMB 064	64	30	100	41	100x85	80x60	17x9	80
3302 MMB 080	80	30	107	41	100x85	80x60	17x9	100
3302 MMB 100	100	30	130	42	100x85	80x60	17x9	110
3302 MMB 125	125	37.5	156	38	100x85	80x60	17x9	150
3302 MMB 140	140	37.5	176	38	100x85	80x60	17x9	160
3302 MMB 150	150	40	182	38	100x85	80x60	17x9	180
3302 MMB 160	160	40	197	54	140x110	105x75-80	13.5x11	210
3302 MMB 180	180	45	218	55	140x110	105x75-80	13.5x11	230
3302 MMB 200	200	50	238	52	140x110	105x75-80	13.5x11	250









MMB
MOBLEN TEKER BURÇLU

KOD NO	 mm	 mm	 mm	 mm	 mm	 mm	 mm	 mm	 kg
3302 MMB 064 F18	64	30	100	41	120	100x85	80x60	17x9	80
3302 MMB 080 F18	80	30	107	41	120	100x85	80x60	17x9	100
3302 MMB 100 F18	100	30	130	42	120	100x85	80x60	17x9	110
3302 MMB 125 F18	125	37.5	156	38	120	100x85	80x60	17x9	150
3302 MMB 140 F18	140	37.5	176	38	120	100x85	80x60	17x9	160
3302 MMB 150 F18	150	40	182	38	120	100x85	80x60	17x9	180
3302 MMB 160 F18	160	40	197	54	150	140x110	105x75-80	13.5x11	210
3302 MMB 180 F18	180	45	218	55	150	140x110	105x75-80	13.5x11	230
3302 MMB 200 F18	200	50	238	52	150	140x110	105x75-80	13.5x11	250











MMS
MOBLEN TEKER MASURALI

KOD NO	 mm	 mm	 mm	 mm	 mm	 mm	 mm	 kg
3302 MMS 064	64	30	100	41	100x85	80x60	17x9	80
3302 MMS 080	80	30	107	41	100x85	80x60	17x9	100
3302 MMS 100	100	30	130	42	100x85	80x60	17x9	110
3302 MMS 125	125	37.5	156	38	100x85	80x60	17x9	150
3302 MMS 140	140	37.5	176	38	100x85	80x60	17x9	160
3302 MMS 150	150	40	182	38	100x85	80x60	17x9	180
3302 MMS 160	160	40	197	54	140x110	105x75-80	13.5x11	210
3302 MMS 180	180	45	218	55	140x110	105x75-80	13.5x11	230
3302 MMS 200	200	50	238	52	140x110	105x75-80	13.5x11	250











PPB		POLİAMİD TEKER BURÇLU						
KOD NO	 mm	 mm	 mm	 mm	 mm	 mm	 mm	 kg
3302 PPB 064	64	30	100	41	100x85	80x60	17x9	120
3302 PPB 080	80	30	107	41	100x85	80x60	17x9	120
3302 PPB 100	100	30	130	42	100x85	80x60	17x9	130
3302 PPB 125	125	37.5	156	38	100x85	80x60	17x9	170
3302 PPB 140	140	37.5	176	38	100x85	80x60	17x9	180
3302 PPB 150	150	40	182	38	100x85	80x60	17x9	200
3302 PPB 160	160	40	197	54	140x110	105x75-80	13.5x11	240
3302 PPB 180	180	45	218	55	140x110	105x75-80	13.5x11	260
3302 PPB 200	200	50	238	52	140x110	105x75-80	13.5x11	290



PPB		POLİAMİD TEKER BURÇLU							
KOD NO	 mm	 mm	 mm	 mm	 mm	 mm	 mm	 mm	 kg
3302 PPB 064 F18	64	30	100	41	120	100x85	80x60	17x9	120
3302 PPB 080 F18	80	30	107	41	120	100x85	80x60	17x9	120
3302 PPB 100 F18	100	30	130	42	120	100x85	80x60	17x9	130
3302 PPB 125 F18	125	37.5	156	38	120	100x85	80x60	17x9	170
3302 PPB 140 F18	140	37.5	176	38	120	100x85	80x60	17x9	180
3302 PPB 150 F18	150	40	182	38	120	100x85	80x60	17x9	200
3302 PPB 160 F18	160	40	197	54	150	140x110	105x75-80	13.5x11	240
3302 PPB 180 F18	180	45	218	55	150	140x110	105x75-80	13.5x11	260
3302 PPB 200 F18	200	50	238	52	150	140x110	105x75-80	13.5x11	290



PPS		POLİAMİD TEKER MASURALI						
KOD NO	 mm	 mm	 mm	 mm	 mm	 mm	 mm	 kg
3302 PPS 080	80	30	107	41	100x85	80x60	17x9	120
3302 PPS 100	100	30	130	42	100x85	80x60	17x9	130
3302 PPS 125	125	37.5	156	38	100x85	80x60	17x9	170
3302 PPS 140	140	37.5	176	38	100x85	80x60	17x9	180
3302 PPS 150	150	40	182	38	100x85	80x60	17x9	200
3302 PPS 160	160	40	197	54	140x110	105x75-80	13.5x11	240
3302 PPS 180	180	45	218	55	140x110	105x75-80	13.5x11	260
3302 PPS 200	200	50	238	52	140x110	105x75-80	13.5x11	290



PPS		POLİAMİD TEKER MASURALI							
KOD NO									
	mm	mm	mm	mm	mm	mm	mm	mm	kg
3302 PPS 080 F18	80	30	107	41	120	100x85	80x60	17x9	120
3302 PPS 100 F18	100	30	130	42	120	100x85	80x60	17x9	130
3302 PPS 125 F18	125	37.5	156	38	120	100x85	80x60	17x9	170
3302 PPS 140 F18	140	37.5	176	38	120	100x85	80x60	17x9	180
3302 PPS 150 F18	150	40	182	38	120	100x85	80x60	17x9	200
3302 PPS 160 F18	160	40	197	54	150	140x110	105x75-80	13.5x11	240
3302 PPS 180 F18	180	45	218	55	150	140x110	105x75-80	13.5x11	260
3302 PPS 200 F18	200	50	238	52	150	140x110	105x75-80	13.5x11	290



MHP		MOBLEN KASNAK ÜZERİ HAVALI LASTİK POLİAMİD BURÇLU							
KOD NO									
	mm	mm	mm	mm	mm	mm	mm	mm	kg
3302 MHP 200	200	50	238	52	140x110	105x75-80	13.5x11		75
3302 MHP 260	260	65	301	52	187x170	120x132	38.5x17		150



MHP		MOBLEN KASNAK ÜZERİ HAVALI LASTİK POLİAMİD BURÇLU							
KOD NO									
	mm	mm	mm	mm	mm	mm	mm	mm	kg
3302 MHP 200 F18	200	50	238	52	150	140x110	120x132	13.5x11	75



MHP		MOBLEN KASNAK ÜZERİ HAVALI LASTİK POLİAMİD BURÇLU							
KOD NO									
	mm	mm	mm	mm	mm	mm	mm	mm	kg
3302 MHP 260 F09	260	65	301	52	146.5	187x170	120x132	38.5x17	150



MHR		MOBLEN KASNAK ÜZERİ HAVALI LASTİK RULMANLI						
KOD NO								
	mm	mm	mm	mm	mm	mm	mm	kg
3302 MHR 200	200	50	238	52	140x110	105x75-80	13.5x11	75
3302 MHR 260	260	65	301	52	187x170	120x132	38.5x17	150



MHR		MOBLEN KASNAK ÜZERİ HAVALI LASTİK RULMANLI							
KOD NO									
	mm	mm	mm	mm	mm	mm	mm	kg	
3302 MHR 200 F18	200	50	238	52	150	140x110	120x132	13.5x11	75



MHR		MOBLEN KASNAK ÜZERİ HAVALI LASTİK RULMANLI							
KOD NO									
	mm	mm	mm	mm	mm	mm	mm	kg	
3302 MHR 260 F09	260	65	301	52	146.5	187x170	120x132	38.5x17	150



SHS		GALVANİZ KAPLI SAC ÜZERİ HAVALI LASTİK MASURALI						
KOD NO								
	mm	mm	mm	mm	mm	mm	mm	kg
3302 SHS 260	260	65	301	52	187x170	120x132	38.5x17	150











SHS		GALVANİZ KAPLI SAC ÜZERİ HAVALI LASTİK MASURALI							
KOD NO									
	mm	mm	mm	mm	mm	mm	mm	kg	
3302 SHS 260 F09	260	65	301	52	146.5	187x170	120x132	38.5x17	150









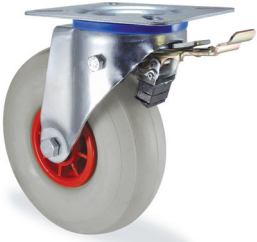

MSS		MOBLEN KASNAK ÜZERİ SİYAH VEYA GRİ DUBLEKS LASTİK KAPLAMA MASURALI						
KOD NO								
	mm	mm	mm	mm	mm	mm	mm	kg
3302 MSS 200	200	50	238	52	140x110	105x75-80	13.5x11	150
3302 MSS 260	260	65	301	52	187x170	120x132	38.5x17	200











MSS
MOBLEN KASNAK ÜZERİ SİYAH VEYA GRİ DUBLEKS LASTİK KAPLAMA MASURALI

KOD NO	 mm	 mm	 mm	 mm	 mm	 mm	 mm	 mm	 kg
3302 MSS 200 F18	200	50	238	52	150	140x110	120x132	13.5x11	150











MSS
MOBLEN KASNAK ÜZERİ SİYAH VEYA GRİ DUBLEKS LASTİK KAPLAMA MASURALI

KOD NO	 mm	 mm	 mm	 mm	 mm	 mm	 mm	 mm	 kg
3302 MSS 260 F09	260	65	301	52	146.5	187x170	120x132	38.5x17	150











SSS
GALVANİZ KAPLI SAC ÜZERİ SİYAH VEYA GRİ DUBLEKS LASTİK KAPLAMA MASURALI

KOD NO	 mm	 mm	 mm	 mm	 mm	 mm	 mm	 mm	 kg
3302 SSS 200	200	50	238	52	150	140x110	105x75-80	13.5x11	150
3302 SSS 260	260	65	301	52	187x170	120x132	38.5x17		200











SSS
GALVANİZ KAPLI SAC ÜZERİ SİYAH VEYA GRİ DUBLEKS LASTİK KAPLAMA MASURALI

KOD NO	 mm	 mm	 mm	 mm	 mm	 mm	 mm	 mm	 kg
3302 SSS 200 F18	200	50	238	52	150	140x110	120x132	13.5x11	150

SSS
GALVANİZ KAPLI SAC ÜZERİ SİYAH VEYA GRİ DUBLEKS LASTİK KAPLAMA MASURALI

KOD NO	 mm	 mm	 mm	 mm	 mm	 mm	 mm	 mm	 kg
3302 SSS 260 F09	260	65	301	52	146.5	187x170	120x132	38.5x17	200

CTB
GÜÇLENDİRİLMİŞ POLİAMİD KASNAK ÜZERİ TERMOELASTİK KAPLAMA BURÇLU

KOD NO	 mm	 mm	 mm	 mm	 mm	 mm	 mm	 mm	 kg
3302 CTB 200	200	50	238	52	150	140x110	105x75-80	13.5x11	250



CTB		GÜÇLENDİRİLMİŞ POLİAMİD KASNAK ÜZERİ TERMOELASTİK KAPLAMA BURÇLU							
KOD NO									
	mm	mm	mm	mm	mm	mm	mm	mm	kg
3302 CTB 200 F18	200	50	238	52	150	140x110	105x75-80	13.5x11	250



CTR		GÜÇLENDİRİLMİŞ POLİAMİD KASNAK ÜZERİ TERMOELASTİK KAPLAMA RULMANLI							
KOD NO									
	mm	mm	mm	mm	mm	mm	mm	mm	kg
3302 CTR 200	200	50	238	52	150	140x110	105x75-80	13.5x11	250



CTR		GÜÇLENDİRİLMİŞ POLİAMİD KASNAK ÜZERİ TERMOELASTİK KAPLAMA RULMANLI							
KOD NO									
	mm	mm	mm	mm	mm	mm	mm	mm	kg
3302 CTR 200 F18	200	50	238	52	150	140x110	105x75-80	13.5x11	250



PYB		POLİAMİD KASNAK ÜZERİ AĞIR TİP VULKANİZE SİYAH LASTİK KAPLAMA BURÇLU							
KOD NO									
	mm	mm	mm	mm	mm	mm	mm	mm	kg
3302 PYB 200	200	50	238	52	150	140x110	105x75-80	13.5x11	250



PYB		POLİAMİD KASNAK ÜZERİ AĞIR TİP VULKANİZE SİYAH LASTİK KAPLAMA BURÇLU							
KOD NO									
	mm	mm	mm	mm	mm	mm	mm	mm	kg
3302 PYB 200 F18	200	50	238	52	150	140x110	105x75-80	13.5x11	250



PYR		POLİAMİD KASNAK ÜZERİ AĞIR TİP VULKANİZE SİYAH LASTİK KAPLAMA RULMANLI							
KOD NO									
	mm	mm	mm	mm	mm	mm	mm	mm	kg
3302 PYR 200	200	50	238	52	150	140x110	105x75-80	13.5x11	250



PYR		POLİAMİD KASNAK ÜZERİ AĞIR TİP VULKANİZE SİYAH LASTİK KAPLAMA RULMANLI							
KOD NO									
	mm	mm	mm	mm	mm	mm	mm	mm	kg
3302 PYR 200 F18	200	50	238	52	150	140x110	105x75-80	13.5x11	250



RMB		AĞIR TİP MOBLEN TEKER BURÇLU							
KOD NO									
	mm	mm	mm	mm	mm	mm	mm	mm	kg
3302 RMB 200	200	50	238	52	150	140x110	105x75-80	13.5x11	280



RMB		AĞIR TİP MOBLEN TEKER BURÇLU							
KOD NO									
	mm	mm	mm	mm	mm	mm	mm	mm	kg
3302 RMB 200 F18	200	50	238	52	150	140x110	105x75-80	13.5x11	280



RPB		AĞIR TİP POLİAMİD TEKER BURÇLU							
KOD NO									
	mm	mm	mm	mm	mm	mm	mm	mm	kg
3302 RPB 200	200	50	238	52	150	140x110	105x75-80	13.5x11	400











RPB		AĞIR TİP POLİAMİD TEKER BURÇLU							
KOD NO									
	mm	mm	mm	mm	mm	mm	mm	mm	kg
3302 RPB 200 F18	200	50	238	52	150	140x110	105x75-80	13.5x11	400



RPR		AĞIR TİP POLİAMİD TEKER RULMANLI							
KOD NO									
	mm	mm	mm	mm	mm	mm	mm	mm	kg
3302 RPR 200	200	50	238	52	150	140x110	105x75-80	13.5x11	400



RPR		AĞIR TİP POLİAMİD TEKER RULMANLI							
KOD NO	 mm	 mm	 mm	 mm	 mm	 mm	 mm	 mm	 kg
3302 RPR 200 F18	200	50	238	52	150	140x110	105x75-80	13.5x11	400

- A:** BAĞLANTI PİMİ
- B:** ÜST BİLYA KAPAĞI
- C:** KÜRESEL METAL TANE BİLYALAR
- D:** ALT BİLYA ÇANAĞI
- E:** OYNAK RULET MAŞASI
- F:** MONTAJ PULU

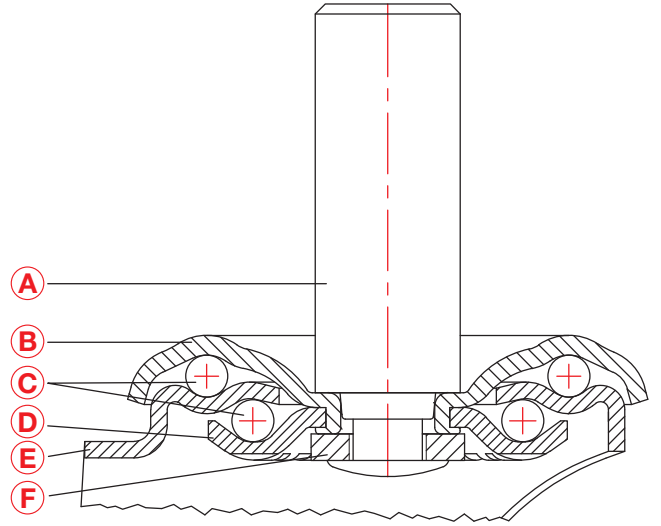

PRS		POLİAMİD KASNAK ÜZERİ MAVİ KAUÇUK LASTİK KAPLAMA MASURALI						
KOD NO	mm	mm	mm	mm	mm	mm	kg	
3305 PRS 080	80	32	106	41	22	39	80	
3305 PRS 100	100	36	129	42	22	39	120	
3305 PRS 125	125	40	155	38	22	50	150	
3305 PRS 150	150	40	181	38	22	50	200	









PRS		POLİAMİD KASNAK ÜZERİ MAVİ KAUÇUK LASTİK KAPLAMA MASURALI						
KOD NO	mm	mm	mm	mm	mm	mm	kg	
3305 PRS 080 F18	80	32	106	41	120	22	39	80
3305 PRS 100 F18	100	36	129	42	120	22	39	120
3305 PRS 125 F18	125	40	155	38	120	22	50	150
3305 PRS 150 F18	150	40	181	38	120	22	50	200









PUB		POLİAMİD KASNAK ÜZERİ POLİÜRETAN KAPLAMA BURÇLU						
KOD NO	mm	mm	mm	mm	mm	mm	kg	
3305 PUB 080	80	30	106	41	22	39	125	
3305 PUB 100	100	30	129	42	22	39	150	
3305 PUB 125	125	37.5	155	38	22	50	180	







3305 Serisi

PUB		POLİAMİD KASNAK ÜZERİ POLİÜRETAN KAPLAMA BURÇLU						
KOD NO	 mm	 mm	 mm	 mm	 mm	 mm	 kg	
3305 PUB 150	150	40	181	38	22	50	260	
3305 PUB 200	200	50	238	52	22	58	400	









PUB		POLİAMİD KASNAK ÜZERİ POLİÜRETAN KAPLAMA BURÇLU						
KOD NO	 mm	 mm	 mm	 mm	 mm	 mm	 kg	
3305 PUB 080 F18	80	30	106	41	120	22	39	125
3305 PUB 100 F18	100	30	129	42	120	22	39	150
3305 PUB 125 F18	125	37.5	155	38	120	22	50	180







PUB		POLİAMİD KASNAK ÜZERİ POLİÜRETAN KAPLAMA BURÇLU						
KOD NO	 mm	 mm	 mm	 mm	 mm	 mm	 kg	
3305 PUB 150 F18	150	40	181	38	120	22	50	260
3305 PUB 200 F18	200	50	238	52	150	22	58	400









PUR		POLİAMİD KASNAK ÜZERİ POLİÜRETAN KAPLAMA RULMANLI						
KOD NO	 mm	 mm	 mm	 mm	 mm	 mm	 kg	
3305 PUR 080	80	32	106	41	22	39	125	
3305 PUR 100	100	32	129	42	22	39	150	
3305 PUR 125	125	32	155	38	22	50	180	











PUR		POLİAMİD KASNAK ÜZERİ POLİÜRETAN KAPLAMA RULMANLI						
KOD NO	 mm	 mm	 mm	 mm	 mm	 mm	 kg	
3305 PUR 200	200	50	238	52	22	58	400	











PUR		POLİAMİD KASNAK ÜZERİ POLİÜRETAN KAPLAMA RULMANLI						
KOD NO	 mm	 mm	 mm	 mm	 mm	 mm	 kg	
3305 PUR 080 F18	80	32	106	41	120	22	39	125
3305 PUR 100 F18	100	32	129	42	120	22	39	150
3305 PUR 125 F18	125	32	155	38	120	22	50	180











PUR		POLİAMİD KASNAK ÜZERİ POLİÜRETAN KAPLAMA RULMANLI						
KOD NO	 mm	 mm	 mm	 mm	 mm	 mm	 mm	 kg
3305 PUR 200 F18	200	50	238	52	150	22	58	400









PUS		POLİAMİD KASNAK ÜZERİ POLİÜRETAN KAPLAMA MASURALI						
KOD NO	 mm	 mm	 mm	 mm	 mm	 mm	 mm	 kg
3305 PUS 080	80	30	106	41	22	39	125	
3305 PUS 100	100	30	129	42	22	39	150	
3305 PUS 125	125	37.5	155	38	22	50	180	
3305 PUS 150	150	40	181	38	22	50	260	







PUS		POLİAMİD KASNAK ÜZERİ POLİÜRETAN KAPLAMA MASURALI						
KOD NO	 mm	 mm	 mm	 mm	 mm	 mm	 mm	 kg
3305 PUS 200	200	50	238	52	22	58	400	



PUS		POLİAMİD KASNAK ÜZERİ POLİÜRETAN KAPLAMA MASURALI						
KOD NO	 mm	 mm	 mm	 mm	 mm	 mm	 mm	 kg
3305 PUS 080 F18	80	30	106	41	120	22	39	125
3305 PUS 100 F18	100	30	129	42	120	22	39	150
3305 PUS 125 F18	125	37.5	155	38	120	22	50	180
3305 PUS 150 F18	150	40	181	38	120	22	50	260



PUS		POLİAMİD KASNAK ÜZERİ POLİÜRETAN KAPLAMA MASURALI						
KOD NO	 mm	 mm	 mm	 mm	 mm	 mm	 mm	 kg
3305 PUS 200 F18	200	50	238	52	150	22	58	400



SLP		GALVANİZ KAPLI SAC ÜZERİ SİYAH KAUÇUK LASTİK KAPLAMA POLİAMİD BURÇLU					
KOD NO							
	mm	mm	mm	mm	mm	mm	kg
3305 SLP 080	80	25	106	41	22	39	50
3305 SLP 100	100	30	125	42	22	39	70
3305 SLP 125	125	37.5	155	38	22	50	100
3305 SLP 140	140	37.5	176	38	22	50	115
3305 SLP 150	150	38	181	38	22	50	125
3305 SLP 160	160	38	197	54	22	58	135
3305 SLP 180	180	45	218	55	22	58	170
3305 SLP 200	200	50	238	52	22	58	205



SLP		GALVANİZ KAPLI SAC ÜZERİ SİYAH KAUÇUK LASTİK KAPLAMA POLİAMİD BURÇLU						
KOD NO								
	mm	mm	mm	mm	mm	mm	kg	
3305 SLP 080 F18	80	25	106	41	120	22	39	50
3305 SLP 100 F18	100	30	125	42	120	22	39	70
3305 SLP 125 F18	125	37.5	155	38	120	22	50	100
3305 SLP 140 F18	140	37.5	176	38	120	22	50	115
3305 SLP 150 F18	150	38	181	38	120	22	50	125
3305 SLP 160 F18	160	38	197	54	150	22	58	135
3305 SLP 180 F18	180	45	218	55	150	22	58	170
3305 SLP 200 F18	200	50	238	52	150	22	58	205



SLS		GALVANİZ KAPLI SAC ÜZERİ SİYAH KAUÇUK LASTİK KAPLAMA MASURALI					
KOD NO							
	mm	mm	mm	mm	mm	mm	kg
3305 SLS 080	80	25	106	41	22	39	50
3305 SLS 100	100	30	125	42	22	39	70
3305 SLS 125	125	37.5	155	38	22	50	100
3305 SLS 140	140	37.5	176	38	22	50	115
3305 SLS 150	150	38	181	38	22	50	125
3305 SLS 160	160	38	197	54	22	58	135
3305 SLS 180	180	45	218	55	22	58	170
3305 SLS 200	200	50	238	52	22	58	205



SLS		GALVANİZ KAPLI SAC ÜZERİ SİYAH KAUÇUK LASTİK KAPLAMA MASURALI						
KOD NO	 mm	 mm	 mm	 mm	 mm	 mm	 mm	 kg
3305 SLS 080 F18	80	25	106	41	120	22	39	50
3305 SLS 100 F18	100	30	125	42	120	22	39	70
3305 SLS 125 F18	125	37.5	155	38	120	22	50	100
3305 SLS 140 F18	140	37.5	176	38	120	22	50	115
3305 SLS 150 F18	150	38	181	38	120	22	50	125
3305 SLS 160 F18	160	38	197	54	150	22	58	135
3305 SLS 180 F18	180	45	218	55	150	22	58	170
3305 SLS 200 F18	200	50	238	52	150	22	58	205



SES		GALVANİZ KAPLI SAC ÜZERİ GRİ KAUÇUK LASTİK KAPLAMA MASURALI						
KOD NO	 mm	 mm	 mm	 mm	 mm	 mm	 mm	 kg
3305 SES 080	80	25	106	41	22	39	50	
3305 SES 100	100	30	125	42	22	39	70	
3305 SES 125	125	37.5	155	38	22	50	100	
3305 SES 140	140	37.5	176	38	22	50	115	
3305 SES 150	150	38	181	38	22	50	125	
3305 SES 160	160	38	197	54	22	58	135	
3305 SES 180	180	45	218	55	22	58	170	
3305 SES 200	200	50	238	52	22	58	205	



SES		GALVANİZ KAPLI SAC ÜZERİ GRİ KAUÇUK LASTİK KAPLAMA MASURALI						
KOD NO	 mm	 mm	 mm	 mm	 mm	 mm	 mm	 kg
3305 SES 080 F18	80	25	106	41	120	22	39	50
3305 SES 100 F18	100	30	125	42	120	22	39	70
3305 SES 125 F18	125	37.5	155	38	120	22	50	100
3305 SES 140 F18	140	37.5	176	38	120	22	50	115
3305 SES 150 F18	150	38	181	38	120	22	50	125
3305 SES 160 F18	160	38	197	54	150	22	58	135
3305 SES 180 F18	180	45	218	55	150	22	58	170
3305 SES 200 F18	200	50	238	52	150	22	58	205



MLB		MOBLEN KASNAK ÜZERİ SİYAH DOLGU LASTİK KAPLAMA BURÇLU						
KOD NO	 mm	 mm	 mm	 mm	 mm	 mm	 kg	
3305 MLB 080	80	25	106	41	22	39	50	
3305 MLB 100	100	30	125	42	22	39	70	
3305 MLB 125	125	37.5	155	38	22	50	100	
3305 MLB 140	140	37.5	176	38	22	50	115	
3305 MLB 150	150	40	181	38	22	50	125	
3305 MLB 160	160	40	197	54	22	58	135	
3305 MLB 180	180	45	218	55	22	58	170	
3305 MLB 200	200	50	238	52	22	58	200	











MLB		MOBLEN KASNAK ÜZERİ SİYAH DOLGU LASTİK KAPLAMA BURÇLU						
KOD NO	 mm	 mm	 mm	 mm	 mm	 mm	 kg	
3305 MLB 080 F18	80	25	106	41	120	22	39	50
3305 MLB 100 F18	100	30	125	42	120	22	39	70
3305 MLB 125 F18	125	37.5	155	38	120	22	50	100
3305 MLB 140 F18	140	37.5	176	38	120	22	50	115
3305 MLB 150 F18	150	40	181	38	120	22	50	125
3305 MLB 160 F18	160	40	197	54	150	22	58	135
3305 MLB 180 F18	180	45	218	55	150	22	58	170
3305 MLB 200 F18	200	50	238	52	150	22	58	200











MLS		MOBLEN KASNAK ÜZERİ SİYAH DOLGU LASTİK KAPLAMA MASURALI						
KOD NO	 mm	 mm	 mm	 mm	 mm	 mm	 kg	
3305 MLS 080	80	30	106	41	22	39	50	
3305 MLS 100	100	30	125	42	22	39	70	
3305 MLS 125	125	37.5	155	38	22	50	100	
3305 MLS 140	140	37.5	176	38	22	50	115	
3305 MLS 150	150	40	181	38	22	50	125	
3305 MLS 160	160	40	197	54	22	58	135	
3305 MLS 180	180	45	218	55	22	58	170	
3305 MLS 200	200	50	238	52	22	58	200	









MLS
MOBLEN KASNAK ÜZERİ SİYAH DOLGU LASTİK KAPLAMA MASURALI

KOD NO	 mm	 mm	 mm	 mm	 mm	 mm	 mm	 kg
3305 MLS 080 F18	80	30	106	41	120	22	39	50
3305 MLS 100 F18	100	30	125	42	120	22	39	70
3305 MLS 125 F18	125	37.5	155	38	120	22	50	100
3305 MLS 140 F18	140	37.5	176	38	120	22	50	115
3305 MLS 150 F18	150	40	181	38	120	22	50	125
3305 MLS 160 F18	160	40	197	54	150	22	58	135
3305 MLS 180 F18	180	45	218	55	150	22	58	170
3305 MLS 200 F18	200	50	238	52	150	22	58	200

MES
MOBLEN KASNAK ÜZERİ GRİ DOLGU LASTİK KAPLAMA MASURALI

KOD NO	 mm	 mm	 mm	 mm	 mm	 mm	 mm	 kg
3305 MES 080	80	30	106	41	22	39	50	
3305 MES 100	100	30	125	42	22	39	70	
3305 MES 125	125	37.5	155	38	22	50	100	
3305 MES 140	140	37.5	176	38	22	50	115	
3305 MES 150	150	40	181	38	22	50	125	
3305 MES 160	160	40	197	54	22	58	135	
3305 MES 180	180	45	218	55	22	58	170	
3305 MES 200	200	50	238	52	22	58	200	







MES
MOBLEN KASNAK ÜZERİ GRİ DOLGU LASTİK KAPLAMA MASURALI

KOD NO	 mm	 mm	 mm	 mm	 mm	 mm	 mm	 kg
3305 MES 080 F18	80	30	106	41	120	22	39	50
3305 MES 100 F18	100	30	125	42	120	22	39	70
3305 MES 125 F18	125	37.5	155	38	120	22	50	100
3305 MES 140 F18	140	37.5	176	38	120	22	50	115
3305 MES 150 F18	150	40	181	38	120	22	50	125
3305 MES 160 F18	160	40	197	54	150	22	58	135
3305 MES 180 F18	180	45	218	55	150	22	58	170
3305 MES 200 F18	200	50	238	52	150	22	58	200









MMB		MOBLEN TEKER BURÇLU					
KOD NO	 mm	 mm	 mm	 mm	 mm	 mm	 kg
3305 MMB 064	64	30	100	41	22	39	80
3305 MMB 080	80	30	106	41	22	39	100
3305 MMB 100	100	30	125	42	22	39	110
3305 MMB 125	125	37.5	155	38	22	50	150
3305 MMB 140	140	37.5	176	38	22	50	160
3305 MMB 150	150	40	181	38	22	50	180
3305 MMB 160	160	40	197	54	22	58	210
3305 MMB 180	180	45	218	55	22	58	230
3305 MMB 200	200	50	238	52	22	58	250



MMB		MOBLEN TEKER BURÇLU						
KOD NO	 mm	 mm	 mm	 mm	 mm	 mm	 kg	
3305 MMB 064 F18	64	30	100	41	120	22	39	80
3305 MMB 080 F18	80	30	106	41	120	22	39	100
3305 MMB 100 F18	100	30	125	42	120	22	39	110
3305 MMB 125 F18	125	37.5	155	38	120	22	50	150
3305 MMB 140 F18	140	37.5	176	38	120	22	50	160
3305 MMB 150 F18	150	40	181	38	150	22	50	180
3305 MMB 160 F18	160	40	197	54	150	22	58	210
3305 MMB 180 F18	180	45	218	55	150	22	58	230
3305 MMB 200 F18	200	50	238	52	150	22	58	250



MMS		MOBLEN TEKER MASURALI					
KOD NO	 mm	 mm	 mm	 mm	 mm	 mm	 kg
3305 MMS 064	64	30	100	41	22	39	80
3305 MMS 080	80	30	106	41	22	39	100
3305 MMS 100	100	30	125	42	22	39	110
3305 MMS 125	125	37.5	155	38	22	50	150
3305 MMS 140	140	37.5	176	38	22	50	160
3305 MMS 150	150	40	181	38	22	50	180
3305 MMS 160	160	40	197	54	22	58	210
3305 MMS 180	180	45	218	55	22	58	230
3305 MMS 200	200	50	238	52	22	58	250



MMS		MOBLEN TEKER MASURALI						
KOD NO								
	mm	mm	mm	mm	mm	mm	mm	kg
3305 MMS 064 F18	64	30	100	41	120	22	39	80
3305 MMS 080 F18	80	30	106	41	120	22	39	100
3305 MMS 100 F18	100	30	125	42	120	22	39	110
3305 MMS 125 F18	125	37.5	155	38	120	22	50	150
3305 MMS 140 F18	140	37.5	176	38	120	22	50	160
3305 MMS 150 F18	150	40	181	38	150	22	50	180
3305 MMS 160 F18	160	40	197	54	150	22	58	210
3305 MMS 180 F18	180	45	218	55	150	22	58	230
3305 MMS 200 F18	200	50	238	52	150	22	58	250



* 150'LİK RULETİMİZDE SIRT KAPLAMASI İNCEDİR.

MTB		MOBLEN KASNAK ÜZERİ TERMOELASTİK KAPLAMA BURÇLU						
KOD NO								
	mm	mm	mm	mm	mm	mm	mm	kg
3305 MTB 080	80	30	106	41	120	22	39	80
3305 MTB 100	100	30	125	42	120	22	39	100
3305 MTB 125	125	37.5	155	38	120	22	50	120
3305 MTB 150	150	40	181	38	120	22	50	130



MTB		MOBLEN KASNAK ÜZERİ TERMOELASTİK KAPLAMA BURÇLU						
KOD NO								
	mm	mm	mm	mm	mm	mm	mm	kg
3305 MTB 080 F18	80	30	106	41	120	22	39	80
3305 MTB 100 F18	100	30	125	42	120	22	39	100
3305 MTB 125 F18	125	37.5	155	38	120	22	50	120
3305 MTB 150 F18	150	40	181	38	120	22	50	130









* 150'LİK RULETİMİZDE SIRT KAPLAMASI İNCEDİR.

MTS		MOBLEN KASNAK ÜZERİ TERMOELASTİK KAPLAMA MASURALI						
KOD NO								
	mm	mm	mm	mm	mm	mm	mm	kg
3305 MTS 080	80	30	106	41	120	22	39	80
3305 MTS 100	100	30	125	42	120	22	39	100
3305 MTS 125	125	37.5	155	38	120	22	50	120
3305 MTS 150	150	40	181	38	120	22	50	130









MTS		MOBLEN KASNAK ÜZERİ TERMOELASTİK KAPLAMA MASURALI						
KOD NO								
	mm	mm	mm	mm	mm	mm	mm	kg
3305 MTS 080 F18	80	30	106	41	120	22	39	80
3305 MTS 100 F18	100	30	125	42	120	22	39	100
3305 MTS 125 F18	125	37.5	155	38	120	22	50	120
3305 MTS 150 F18	150	40	181	38	120	22	50	130









PPB		POLİAMİD TEKER BURÇLU						
KOD NO	 mm	 mm	 mm	 mm	 mm	 mm	 kg	
3305 PPB 064	64	30	100	41	22	39	120	
3305 PPB 080	80	30	106	41	22	39	120	
3305 PPB 100	100	30	125	42	22	39	130	
3305 PPB 125	125	37.5	155	38	22	50	170	
3305 PPB 140	140	37.5	176	38	22	50	180	
3305 PPB 150	150	40	181	38	22	50	200	
3305 PPB 160	160	40	197	54	22	58	240	
3305 PPB 180	180	45	218	55	22	58	260	
3305 PPB 200	200	50	238	52	22	58	290	











PPB		POLİAMİD TEKER BURÇLU						
KOD NO	 mm	 mm	 mm	 mm	 mm	 mm	 kg	
3305 PPB 064 F18	64	30	100	41	120	22	39	120
3305 PPB 080 F18	80	30	106	41	120	22	39	120
3305 PPB 100 F18	100	30	125	42	120	22	39	130
3305 PPB 125 F18	125	37.5	155	38	120	22	50	170
3305 PPB 140 F18	140	37.5	176	38	120	22	50	180
3305 PPB 150 F18	150	40	181	38	120	22	50	200
3305 PPB 160 F18	160	40	197	54	150	22	58	240
3305 PPB 180 F18	180	45	218	55	150	22	58	260
3305 PPB 200 F18	200	50	238	52	150	22	58	290



PPS		POLİAMİD TEKER MASURALI						
KOD NO	 mm	 mm	 mm	 mm	 mm	 mm	 kg	
3305 PPS 080	80	30	106	41	22	39	120	
3305 PPS 100	100	30	125	42	22	39	130	
3305 PPS 125	125	37.5	155	38	22	50	170	
3305 PPS 140	140	37.5	176	38	22	50	180	
3305 PPS 150	150	40	181	38	22	50	200	
3305 PPS 160	160	40	197	54	22	58	240	
3305 PPS 180	180	45	218	55	22	58	260	
3305 PPS 200	200	50	238	52	22	58	290	



PPS		POLİAMİD TEKER MASURALI						
KOD NO								
	mm	mm	mm	mm	mm	mm	mm	kg
3305 PPS 080 F18	80	30	106	41	120	22	39	120
3305 PPS 100 F18	100	30	125	42	120	22	39	130
3305 PPS 125 F18	125	37.5	155	38	120	22	50	170
3305 PPS 140 F18	140	37.5	176	38	120	22	50	180
3305 PPS 150 F18	150	40	181	38	120	22	50	200
3305 PPS 160 F18	160	40	197	54	150	22	58	240
3305 PPS 180 F18	180	45	218	55	150	22	58	260
3305 PPS 200 F18	200	50	238	52	150	22	58	290





SSS		GALVANİZ KAPLI SAC ÜZERİ SİYAH VEYA GRİ DUBLEKS LASTİK KAPLAMA MASURALI						
KOD NO								
	mm	mm	mm	mm	mm	mm	mm	kg
3305 SSS 200	200	50	238	52	22	58		150





SSS		GALVANİZ KAPLI SAC ÜZERİ SİYAH VEYA GRİ DUBLEKS LASTİK KAPLAMA MASURALI						
KOD NO								
	mm	mm	mm	mm	mm	mm	mm	kg
3305 SSS 200 F18	200	50	238	52	150	22	58	150









CTB		GÜÇLENDİRİLMİŞ POLİAMİD KASNAK ÜZERİ TERMOELASTİK GRİ LASTİK KAPLAMA BURÇLU						
KOD NO								
	mm	mm	mm	mm	mm	mm	mm	kg
3305 CTB 200	200	50	238	52	22	58		250









CTB		GÜÇLENDİRİLMİŞ POLİAMİD KASNAK ÜZERİ TERMOELASTİK GRİ LASTİK KAPLAMA BURÇLU						
KOD NO								
	mm	mm	mm	mm	mm	mm	mm	kg
3305 CTB 200 F18	200	50	238	52	150	22	58	250



CTR		GÜÇLENDİRİLMİŞ POLİAMİD KASNAK ÜZERİ TERMOELASTİK GRİ LASTİK KAPLAMA RULMANLI						
KOD NO	 mm	 mm	 mm	 mm	 mm	 mm	 kg	
3305 CTR 200	200	50	238	52	22	58	250	



CTR		GÜÇLENDİRİLMİŞ POLİAMİD KASNAK ÜZERİ TERMOELASTİK GRİ LASTİK KAPLAMA RULMANLI						
KOD NO	 mm	 mm	 mm	 mm	 mm	 mm	 kg	
3305 CTR 200 F18	200	50	238	52	150	22	58	250



PYB		POLİAMİD KASNAK ÜZERİ AĞIR TİP VULKANİZE SİYAH LASTİK KAPLAMA BURÇLU						
KOD NO	 mm	 mm	 mm	 mm	 mm	 mm	 kg	
3305 PYB 200	200	50	238	52	22	58	250	



PYB		POLİAMİD KASNAK ÜZERİ AĞIR TİP VULKANİZE SİYAH LASTİK KAPLAMA BURÇLU						
KOD NO	 mm	 mm	 mm	 mm	 mm	 mm	 kg	
3305 PYB 200 F18	200	50	238	52	150	22	58	250









PYR		POLİAMİD KASNAK ÜZERİ AĞIR TİP VULKANİZE SİYAH LASTİK KAPLAMA RULMANLI						
KOD NO	 mm	 mm	 mm	 mm	 mm	 mm	 kg	
3305 PYR 200	200	50	238	52	22	58	250	









PYR		POLİAMİD KASNAK ÜZERİ AĞIR TİP VULKANİZE SİYAH LASTİK KAPLAMA RULMANLI						
KOD NO	 mm	 mm	 mm	 mm	 mm	 mm	 kg	
3305 PYR 200 F18	200	50	238	52	150	22	58	250









RMB		AĞIR TİP MOBLEN TEKER BURÇLU						
KOD NO								
	mm	mm	mm	mm	mm	mm	kg	
3305 RMB 200	200	50	238	52	22	58	280	









RMB		AĞIR TİP MOBLEN TEKER BURÇLU						
KOD NO								
	mm	mm	mm	mm	mm	mm	kg	
3305 RMB 200 F18	200	50	238	52	150	22	58	280









RPB		AĞIR TİP POLİAMİD TEKER BURÇLU						
KOD NO								
	mm	mm	mm	mm	mm	mm	kg	
3305 RPB 200	200	50	238	52	22	58	400	











RPB		AĞIR TİP POLİAMİD TEKER BURÇLU						
KOD NO								
	mm	mm	mm	mm	mm	mm	kg	
3305 RPB 200 F18	200	50	238	52	150	22	58	400



RPR		AĞIR TİP POLİAMİD TEKER RULMANLI						
KOD NO								
	mm	mm	mm	mm	mm	mm	kg	
3305 RPR 200	200	50	238	52	22	58	400	



RPR		AĞIR TİP POLİAMİD TEKER RULMANLI						
KOD NO	 mm	 mm	 mm	 mm	 mm	 mm	 mm	 kg
3305 RPR 200 F18	200	50	238	52	150	22	58	400

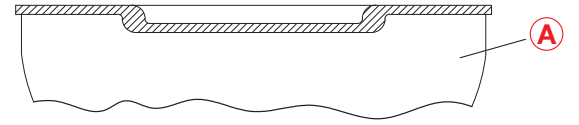

A: SABİT MAŞA

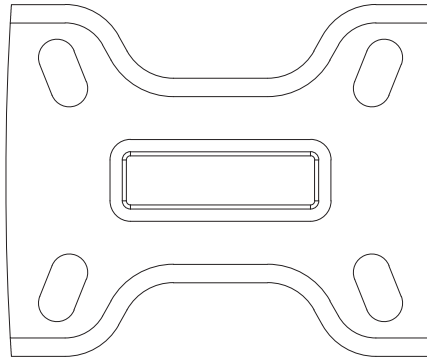

PRS		POLİAMİD KASNAK ÜZERİ MAVİ KAUÇUK LASTİK KAPLAMA MASURALI					
KOD NO	mm	mm	mm	mm	mm	mm	kg
3307 PRS 080	80	32	107	100x86	80x61	17x9	80
3307 PRS 100	100	36	130	100x86	80x61	17x9	120
3307 PRS 125	125	40	156	105x86	80x61	17x9	150
3307 PRS 150	150	40	182	105x86	80x61	17x9	200









PUB		POLİAMİD KASNAK ÜZERİ POLİÜRETAN KAPLAMA BURÇLU					
KOD NO	mm	mm	mm	mm	mm	mm	kg
3307 PUB 080	80	30	107	100x86	80x61	17x9	125
3307 PUB 100	100	30	130	100x86	80x61	17x9	150
3307 PUB 125	125	37.5	156	105x86	80x61	17x9	180





PUB		POLİAMİD KASNAK ÜZERİ POLİÜRETAN KAPLAMA BURÇLU					
KOD NO	mm	mm	mm	mm	mm	mm	kg
3307 PUB 150	150	40	182	105x86	80x61	17x9	260
3307 PUB 200	200	50	238	134x114	105x75-80	13.5x11	400







PUR		POLİAMİD KASNAK ÜZERİ POLİÜRETAN KAPLAMA RULMANLI						
KOD NO								
	mm	mm	mm	mm	mm	mm	kg	
3307 PUR 080	80	32	107	100x86	80x61	17x9	125	
3307 PUR 100	100	32	130	100x86	80x61	17x9	150	
3307 PUR 125	125	32	156	105x86	80x61	17x9	180	









PUR		POLİAMİD KASNAK ÜZERİ POLİÜRETAN KAPLAMA RULMANLI						
KOD NO								
	mm	mm	mm	mm	mm	mm	kg	
3307 PUR 200	200	50	238	134x114	105x75-80	13.5x11	400	



PUS		POLİAMİD KASNAK ÜZERİ POLİÜRETAN KAPLAMA MASURALI						
KOD NO								
	mm	mm	mm	mm	mm	mm	kg	
3307 PUS 080	80	30	107	100x86	80x61	17x9	125	
3307 PUS 100	100	30	130	100x86	80x61	17x9	150	
3307 PUS 125	125	37.5	156	105x86	80x61	17x9	180	



PUS		POLİAMİD KASNAK ÜZERİ POLİÜRETAN KAPLAMA MASURALI						
KOD NO								
	mm	mm	mm	mm	mm	mm	kg	
3307 PUS 150	150	40	182	105x86	80x61	17x9	260	
3307 PUS 200	200	50	238	134x114	105x75-80	13.5x11	400	



SLP		GALVANİZ KAPLI SAC ÜZERİ SİYAH KAUKÜK LASTİK KAPLAMA POLİAMİD BURÇLU						
KOD NO								
	mm	mm	mm	mm	mm	mm	kg	
3307 SLP 080	80	25	108	100x86	80x61	17x9	50	
3307 SLP 100	100	30	130	100x86	80x61	17x9	70	
3307 SLP 125	125	37.5	156	105x86	80x61	17x9	100	
3307 SLP 140	140	37.5	177	105x86	80x61	17x9	115	
3307 SLP 150	150	38	182	105x86	80x61	17x9	125	
3307 SLP 160	160	38	199	134x114	105x75-80	13.5x11	135	
3307 SLP 180	180	45	220	134x114	105x75-80	13.5x11	170	
3307 SLP 200	200	50	240	134x114	105x75-80	13.5x11	205	
3307 SLP 250	250	60	295	190x157	140x100	17	295	
3307 SLP 280	280	70	310	190x157	140x100	17	350	



SLS		GALVANİZ KAPLI SAC ÜZERİ SİYAH KAUÇUK LASTİK KAPLAMA MASURALI						
KOD NO								
	mm	mm	mm	mm	mm	mm	kg	
3307 SLS 080	80	25	108	100x86	80x61	17x9	50	
3307 SLS 100	100	30	130	100x86	80x61	17x9	70	
3307 SLS 125	125	37.5	156	105x86	80x61	17x9	100	
3307 SLS 140	140	37.5	177	105x86	80x61	17x9	115	
3307 SLS 150	150	38	182	105x86	80x61	17x9	125	
3307 SLS 160	160	38	199	134x114	105x75-80	13.5x11	135	
3307 SLS 180	180	45	220	134x114	105x75-80	13.5x11	170	
3307 SLS 200	200	50	240	134x114	105x75-80	13.5x11	205	
3307 SLS 250	250	60	295	190x157	140x100	17	295	
3307 SLS 280	280	70	310	190x157	140x100	17	350	



SES		GALVANİZ KAPLI SAC ÜZERİ GRİ KAUÇUK LASTİK KAPLAMA MASURALI						
KOD NO								
	mm	mm	mm	mm	mm	mm	kg	
3307 SES 080	80	25	108	100x86	80x61	17x9	50	
3307 SES 100	100	30	130	100x86	80x61	17x9	70	
3307 SES 125	125	37.5	156	105x86	80x61	17x9	100	
3307 SES 140	140	37.5	177	105x86	80x61	17x9	115	
3307 SES 150	150	38	182	105x86	80x61	17x9	125	
3307 SES 160	160	38	199	134x114	105x75-80	13.5x11	135	
3307 SES 180	180	45	220	134x114	105x75-80	13.5x11	170	
3307 SES 200	200	50	240	134x114	105x75-80	13.5x11	205	
3307 SES 250	250	60	295	190x157	140x100	17	295	
3307 SES 280	280	70	310	190x157	140x100	17	350	



MLB		MOBLEN KASNAK ÜZERİ SİYAH DOLGU LASTİK KAPLAMA BURÇLU						
KOD NO								
	mm	mm	mm	mm	mm	mm	kg	
3307 MLB 080	80	25	107	100x86	80x61	17x9	50	
3307 MLB 100	100	30	130	100x86	80x61	17x9	70	
3307 MLB 125	125	37.5	156	105x86	80x61	17x9	100	
3307 MLB 140	140	37.5	176	105x86	80x61	17x9	115	
3307 MLB 150	150	40	182	105x86	80x61	17x9	135	
3307 MLB 160	160	40	197	134x114	105x75-80	13.5x11	135	
3307 MLB 180	180	45	218	134x114	105x75-80	13.5x11	170	
3307 MLB 200	200	50	238	134x114	105x75-80	13.5x11	220	









MLS		MOBLEN KASNAK ÜZERİ SİYAH DOLGU LASTİK KAPLAMA MASURALI					
KOD NO	 mm	 mm	 mm	 mm	 mm	 mm	 kg
3307 MLS 080	80	30	107	100x86	80x61	17x9	50
3307 MLS 100	100	30	130	100x86	80x61	17x9	70
3307 MLS 125	125	37.5	156	105x86	80x61	17x9	100
3307 MLS 140	140	37.5	176	105x86	80x61	17x9	115
3307 MLS 150	150	40	182	105x86	80x61	17x9	125
3307 MLS 160	160	40	197	134x114	105x75-80	13.5x11	135
3307 MLS 180	180	45	218	134x114	105x75-80	13.5x11	170
3307 MLS 200	200	50	238	134x114	105x75-80	13.5x11	220









MES		MOBLEN KASNAK ÜZERİ GRİ DOLGU LASTİK KAPLAMA MASURALI					
KOD NO	 mm	 mm	 mm	 mm	 mm	 mm	 kg
3307 MES 080	80	30	107	100x86	80x61	17x9	50
3307 MES 100	100	30	130	100x86	80x61	17x9	70
3307 MES 125	125	37.5	156	105x86	80x61	17x9	100
3307 MES 140	140	37.5	176	105x86	80x61	17x9	115
3307 MES 150	150	40	182	105x86	80x61	17x9	125
3307 MES 160	160	40	197	134x114	105x75-80	13.5x11	135
3307 MES 180	180	45	218	134x114	105x75-80	13.5x11	170
3307 MES 200	200	50	238	134x114	105x75-80	13.5x11	220





MMB		MOBLEN TEKER BURÇLU					
KOD NO	 mm	 mm	 mm	 mm	 mm	 mm	 kg
3307 MMB 064	64	30	100	100x86	80x61	17x9	80
3307 MMB 080	80	30	107	100x86	80x61	17x9	100
3307 MMB 100	100	30	130	100x86	80x61	17x9	110
3307 MMB 125	125	37.5	156	105x86	80x61	17x9	150
3307 MMB 140	140	37.5	176	105x86	80x61	17x9	160
3307 MMB 150	150	40	182	105x86	80x61	17x9	180
3307 MMB 160	160	40	197	134x114	105x75-80	13.5x11	210
3307 MMB 180	180	45	218	134x114	105x75-80	13.5x11	230
3307 MMB 200	200	50	238	134x114	105x75-80	13.5x11	250



PPS		POLİAMİD TEKER MASURALI						
KOD NO	 mm	 mm	 mm	 mm	 mm	 mm	 kg	
3307 PPS 064	64	30	100	100x86	80x61	17x9	120	
3307 PPS 080	80	30	107	100x86	80x61	17x9	120	
3307 PPS 100	100	30	130	100x86	80x61	17x9	130	
3307 PPS 125	125	37.5	156	105x86	80x61	17x9	170	
3307 PPS 140	140	37.5	176	105x86	80x61	17x9	180	
3307 PPS 150	150	40	182	105x86	80x61	17x9	200	
3307 PPS 160	160	40	197	134x114	105x75-80	13.5x11	240	
3307 PPS 180	180	45	218	134x114	105x75-80	13.5x11	260	
3307 PPS 200	200	50	238	134x114	105x75-80	13.5x11	290	



MHP		MOBLEN KASNAK ÜZERİ HAVALI LASTİK POLİAMİD BURÇLU						
KOD NO	 mm	 mm	 mm	 mm	 mm	 mm	 kg	
3307 MHP 200	200	50	238	134x114	105x75-80	13.5x11	75	
3307 MHP 260	260	65	300	190x157	140x100	17	150	









MHR		MOBLEN KASNAK ÜZERİ HAVALI LASTİK RULMANLI						
KOD NO	 mm	 mm	 mm	 mm	 mm	 mm	 kg	
3307 MHR 200	200	50	238	134x114	105x75-80	13.5x11	75	
3307 MHR 260	260	65	300	190x157	140x100	17	150	









SHS		GALVANİZ KAPLI SAC ÜZERİ HAVALI LASTİK MASURALI						
KOD NO	 mm	 mm	 mm	 mm	 mm	 mm	 kg	
3307 SHS 260	260	65	300	190x157	140x100	17	150	









MSS		MOBLEN KASNAK ÜZERİ SİYAH VEYA GRİ DUBLEKS LASTİK KAPLAMA MASURALI						
KOD NO	 mm	 mm	 mm	 mm	 mm	 mm	 kg	
3307 MSS 200	200	50	238	134x114	105x75-80	13.5x11	75	
3307 MSS 260	260	65	300	190x157	140x100	17	150	









SSS		GALVANİZ KAPLI SAC ÜZERİ SİYAH VEYA GRİ DUBLEKS LASTİK KAPLAMA MASURALI						
KOD NO								
	mm	mm	mm	mm	mm	mm	kg	
3307 SSS 200	200	50	238	134x114	105x75-80	13.5x11	150	
3307 SSS 260	260	65	300	190x157	140x100	17	200	



CTB		GÜÇLENDİRİLMİŞ POLİAMİD KASNAK ÜZERİ TERMOELASTİK KAPLAMA BURÇLU						
KOD NO								
	mm	mm	mm	mm	mm	mm	kg	
3307 CTB 200	200	50	238	134x114	105x75-80	13.5x11	250	



CTR		GÜÇLENDİRİLMİŞ POLİAMİD KASNAK ÜZERİ TERMOELASTİK KAPLAMA RULMANLI						
KOD NO								
	mm	mm	mm	mm	mm	mm	kg	
3307 CTR 200	200	50	238	134x114	105x75-80	13.5x11	250	









PYB		POLİAMİD KASNAK ÜZERİ AĞIR TİP VULKANİZE SİYAH LASTİK KAPLAMA BURÇLU						
KOD NO								
	mm	mm	mm	mm	mm	mm	kg	
3307 PYB 200	200	50	238	134x114	105x75-80	13.5x11	250	









PYR		POLİAMİD KASNAK ÜZERİ AĞIR TİP VULKANİZE SİYAH LASTİK KAPLAMA RULMANLI						
KOD NO								
	mm	mm	mm	mm	mm	mm	kg	
3307 PYR 200	200	50	238	134x114	105x75-80	13.5x11	250	







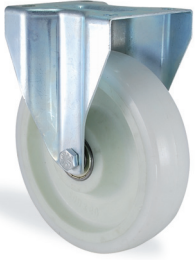

RMB		AĞIR TİP MOBLEN TEKER BURÇLU						
KOD NO								
	mm	mm	mm	mm	mm	mm	kg	
3307 RMB 200	200	50	238	134x114	105x75-80	13.5x11	280	



RPB		AĞIR TİP POLİAMİD TEKER BURÇLU						
KOD NO	 mm	 mm	 mm	 mm	 mm	 mm	 kg	
3307 RPB 200	200	50	238	134x114	105x75-80	13.5x11	400	



RPR		AĞIR TİP POLİAMİD TEKER RULMANLI						
KOD NO	 mm	 mm	 mm	 mm	 mm	 mm	 kg	
3307 RPR 200	200	50	238	134x114	105x75-80	13.5x11	400	

- A:** IMBUS CİVATA
- B:** KARE SOMUN
- C:** SOKET VE SOMUN ALTI TAKVİYELİ PLASTİK
- D:** SOKET
- E:** BORU PERÇİNİ
- F:** RONDELA
- G:** ÜST BİLYA KAPAĞI
- H:** KÜRESEL METAL TANE BİLYALAR
- I:** OYNAK RULET MAŞASI
- J:** ALT BİLYA ÇANAĞI
- K:** MONTAJ PULU

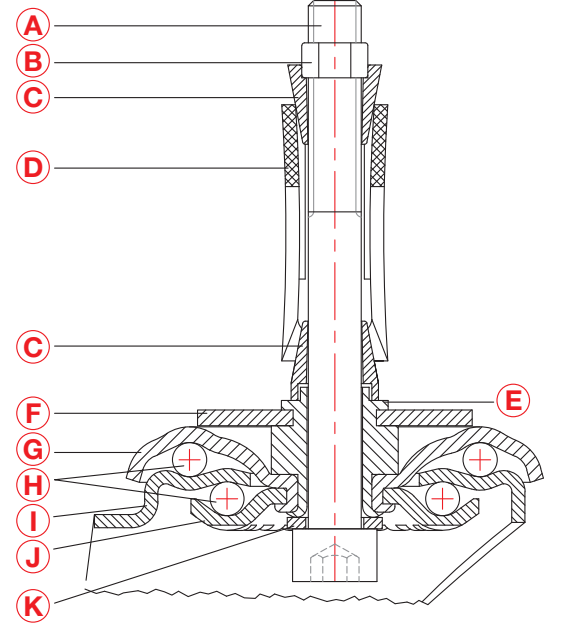

PRS		POLİAMİD KASNAK ÜZERİ MAVİ KAUKÇUK LASTİK KAPLAMA MASURALI				
KOD NO	mm	mm	mm	mm	mm	kg
3325 PRS 080	80	32	110	41	80	80
3325 PRS 100	100	36	133	42	80	120
3325 PRS 125	125	40	159	38	80	150
3325 PRS 150	150	40	185	38	80	200



PRS		POLİAMİD KASNAK ÜZERİ MAVİ KAUKÇUK LASTİK KAPLAMA MASURALI				
KOD NO	mm	mm	mm	mm	mm	kg
3325 PRS 080 F18	80	32	110	41	120	80
3325 PRS 100 F18	100	36	133	42	120	120
3325 PRS 125 F18	125	40	159	38	120	150
3325 PRS 150 F18	150	40	185	38	120	200









PUB		POLİAMİD KASNAK ÜZERİ POLİÜRETAN KAPLAMA BURÇLU				
KOD NO	mm	mm	mm	mm	mm	kg
3325 PUB 080	80	30	110	41	80	125
3325 PUB 100	100	30	133	42	80	150
3325 PUB 125	125	37.5	159	38	80	180
3325 PUB 150	150	40	185	38	80	260







* 150'LİK RULETİMİZDE SIRT KAPLAMASI İNCE DİR.









* 150'LİK RULETİMİZDE SIRT KAPLAMASI İNCE DİR.

PUB		POLİAMİD KASNAK ÜZERİ POLİÜRETAN KAPLAMA BURÇLU					
KOD NO	 mm	 mm	 mm	 mm	 mm	 mm	 kg
3325 PUB 080 F18	80	30	110	41	120	80	125
3325 PUB 100 F18	100	30	133	42	120	80	150
3325 PUB 125 F18	125	37.5	159	38	120	80	180
3325 PUB 150 F18	150	40	185	38	120	80	260









PUR		POLİAMİD KASNAK ÜZERİ POLİÜRETAN KAPLAMA RULMANLI					
KOD NO	 mm	 mm	 mm	 mm	 mm	 mm	 kg
3325 PUR 080	80	32	110	41	80	125	125
3325 PUR 100	100	32	133	42	80	150	150
3325 PUR 125	125	32	159	38	80	180	180









PUR		POLİAMİD KASNAK ÜZERİ POLİÜRETAN KAPLAMA RULMANLI					
KOD NO	 mm	 mm	 mm	 mm	 mm	 mm	 kg
3325 PUR 080 F18	80	32	110	41	120	80	125
3325 PUR 100 F18	100	32	133	42	120	80	150
3325 PUR 125 F18	125	32	159	38	120	80	180



* 150'LİK RULETİMİZDE SIRT KAPLAMASI İNCE DİR.

PUS		POLİAMİD KASNAK ÜZERİ POLİÜRETAN KAPLAMA MASURALI					
KOD NO	 mm	 mm	 mm	 mm	 mm	 mm	 kg
3325 PUS 080	80	30	110	41	80	125	125
3325 PUS 100	100	30	133	42	80	150	150
3325 PUS 125	125	37.5	159	38	80	180	180
3325 PUS 150	150	40	185	38	80	260	260



PUS		POLİAMİD KASNAK ÜZERİ POLİÜRETAN KAPLAMA MASURALI					
KOD NO	 mm	 mm	 mm	 mm	 mm	 mm	 kg
3325 PUS 080 F18	80	30	110	41	120	80	125
3325 PUS 100 F18	100	30	133	42	120	80	150
3325 PUS 125 F18	125	37.5	159	38	120	80	180
3325 PUS 150 F18	150	40	185	38	120	80	260

SLP
GALVANİZ KAPLI SAC ÜZERİ SİYAH KAUÇUK LASTİK KAPLAMA POLİAMİD BURÇLU

KOD NO	mm	mm	mm	mm	mm	kg
3325 SLP 080	80	25	112	41	80	50
3325 SLP 100	100	30	134	42	80	70
3325 SLP 125	125	37.5	160	38	80	100
3325 SLP 140	140	37.5	181	38	80	115
3325 SLP 150	150	38	186	38	80	125

SLP
GALVANİZ KAPLI SAC ÜZERİ SİYAH KAUÇUK LASTİK KAPLAMA POLİAMİD BURÇLU

KOD NO	mm	mm	mm	mm	mm	kg
3325 SLP 080 F18	80	25	112	41	120	50
3325 SLP 100 F18	100	30	134	42	120	70
3325 SLP 125 F18	125	37.5	160	38	120	100
3325 SLP 140 F18	140	37.5	181	38	120	115
3325 SLP 150 F18	150	38	186	38	120	125

SLS
GALVANİZ KAPLI SAC ÜZERİ SİYAH KAUÇUK LASTİK KAPLAMA MASURALI

KOD NO	mm	mm	mm	mm	mm	kg
3325 SLS 080	80	25	112	41	80	50
3325 SLS 100	100	30	134	42	80	70
3325 SLS 125	125	37.5	160	38	80	100
3325 SLS 140	140	37.5	181	38	80	115
3325 SLS 150	150	38	186	38	80	125

SLS
GALVANİZ KAPLI SAC ÜZERİ SİYAH KAUÇUK LASTİK KAPLAMA MASURALI

KOD NO	mm	mm	mm	mm	mm	kg
3325 SLS 080 F18	80	25	112	41	120	50
3325 SLS 100 F18	100	30	134	42	120	70
3325 SLS 125 F18	125	37.5	160	38	120	100
3325 SLS 140 F18	140	37.5	181	38	120	115
3325 SLS 150 F18	150	38	186	38	120	125

SES
GALVANİZ KAPLI SAC ÜZERİ GRİ KAUÇUK LASTİK KAPLAMA MASURALI

KOD NO	mm	mm	mm	mm	mm	kg
3325 SES 080	80	25	112	41	80	50
3325 SES 100	100	30	134	42	80	70
3325 SES 125	125	37.5	160	38	80	100
3325 SES 140	140	37.5	181	38	80	115
3325 SES 150	150	38	186	38	80	125









MES		MOBLEN KASNAK ÜZERİ GRİ DOLGU LASTİK KAPLAMA MASURALI				
KOD NO	 mm	 mm	 mm	 mm	 mm	 kg
3325 MES 080	80	30	110	41	80	50
3325 MES 100	100	30	133	42	80	70
3325 MES 125	125	37.5	159	38	80	100
3325 MES 140	140	37.5	179	38	80	115
3325 MES 150	150	40	185	38	80	125









MES		MOBLEN KASNAK ÜZERİ GRİ DOLGU LASTİK KAPLAMA MASURALI				
KOD NO	 mm	 mm	 mm	 mm	 mm	 kg
3325 MES 080 F18	80	30	110	41	120	50
3325 MES 100 F18	100	30	133	42	120	70
3325 MES 125 F18	125	37.5	159	38	120	100
3325 MES 140 F18	140	37.5	179	38	120	115
3325 MES 150 F18	150	40	185	38	120	125



MMB		MOBLEN TEKER BURÇLU				
KOD NO	 mm	 mm	 mm	 mm	 mm	 kg
3325 MMB 064	64	30	104	41	80	80
3325 MMB 080	80	30	110	41	80	100
3325 MMB 100	100	30	133	42	80	110
3325 MMB 125	125	37.5	159	38	80	150
3325 MMB 140	140	37.5	179	38	80	160
3325 MMB 150	150	40	185	38	80	180



MMB		MOBLEN TEKER BURÇLU				
KOD NO	 mm	 mm	 mm	 mm	 mm	 kg
3325 MMB 064 F18	64	30	104	41	120	80
3325 MMB 080 F18	80	30	110	41	120	100
3325 MMB 100 F18	100	30	133	42	120	110
3325 MMB 125 F18	125	37.5	159	38	120	150
3325 MMB 140 F18	140	37.5	179	38	120	160
3325 MMB 150 F18	150	40	185	38	120	180

**MMS****MOBLEN TEKER MASURALI**

KOD NO	mm	mm	mm	mm	mm	kg
3325 MMS 064	64	30	104	41	80	80
3325 MMS 080	80	30	110	41	80	100
3325 MMS 100	100	30	133	42	80	110
3325 MMS 125	125	37.5	159	38	80	150
3325 MMS 140	140	37.5	179	38	80	160
3325 MMS 150	150	40	185	38	80	180

**MMS****MOBLEN TEKER MASURALI**

KOD NO	mm	mm	mm	mm	mm	kg
3325 MMS 064 F18	64	30	104	41	120	80
3325 MMS 080 F18	80	30	110	41	120	100
3325 MMS 100 F18	100	30	133	42	120	110
3325 MMS 125 F18	125	37.5	159	38	120	150
3325 MMS 140 F18	140	37.5	179	38	120	160
3325 MMS 150 F18	150	40	185	38	120	180

**MTB****MOBLEN KASNAK ÜZERİ TERMOELASTİK KAPLAMA BURÇLU**

KOD NO	mm	mm	mm	mm	mm	kg
3325 MTB 080	80	30	110	41	80	80
3325 MTB 100	100	30	133	42	80	100
3325 MTB 125	125	37.5	159	38	80	120
3325 MTB 150	150	40	185	38	80	130

* 150'LİK RULETİMİZDE SIRT KAPLAMASI İNCE DİR.

**MTB****MOBLEN KASNAK ÜZERİ TERMOELASTİK KAPLAMA BURÇLU**

KOD NO	mm	mm	mm	mm	mm	kg
3325 MTB 080 F18	80	30	110	41	120	80
3325 MTB 100 F18	100	30	133	42	120	100
3325 MTB 125 F18	125	37.5	159	38	120	120
3325 MTB 150 F18	150	40	185	38	120	130

**MTS****MOBLEN KASNAK ÜZERİ TERMOELASTİK KAPLAMA MASURALI**

KOD NO	mm	mm	mm	mm	mm	kg
3325 MTS 080	80	30	110	41	80	80
3325 MTS 100	100	30	133	42	80	100
3325 MTS 125	125	37.5	159	38	80	120
3325 MTS 150	150	40	185	38	80	130

* 150'LİK RULETİMİZDE SIRT KAPLAMASI İNCE DİR.



* 150'LİK RULETİMİZDE SIRT KAPLAMASI İNCE DİR.

MTS
MOBLEN KASNAK ÜZERİ TERMOELASTİK KAPLAMA MASURALI

KOD NO	mm	mm	mm	mm	mm	mm	kg
3325 MTS 080 F18	80	30	110	41	120	80	80
3325 MTS 100 F18	100	30	133	42	120	80	100
3325 MTS 125 F18	125	37.5	159	38	120	80	120
3325 MTS 150 F18	150	40	185	38	120	80	130

PPB
POLİAMİD TEKER BURÇLU

KOD NO	mm	mm	mm	mm	mm	mm	kg
3325 PPB 064	64	30	104	41	80	80	120
3325 PPB 080	80	30	110	41	80	80	120
3325 PPB 100	100	30	133	42	80	80	130
3325 PPB 125	125	37.5	159	38	80	80	170
3325 PPB 140	140	37.5	179	38	80	80	180
3325 PPB 150	150	40	185	38	80	80	200









PPB
POLİAMİD TEKER BURÇLU

KOD NO	mm	mm	mm	mm	mm	mm	kg
3325 PPB 064 F18	64	30	104	41	120	80	120
3325 PPB 080 F18	80	30	110	41	120	80	120
3325 PPB 100 F18	100	30	133	42	120	80	130
3325 PPB 125 F18	125	37.5	159	38	120	80	170
3325 PPB 140 F18	140	37.5	179	38	120	80	180
3325 PPB 150 F18	150	40	185	38	120	80	200



PPS
POLİAMİD TEKER MASURALI

KOD NO	mm	mm	mm	mm	mm	mm	kg
3325 PPS 064	64	30	104	41	80	80	120
3325 PPS 080	80	30	110	41	80	80	120
3325 PPS 100	100	30	133	42	80	80	130
3325 PPS 125	125	37.5	159	38	80	80	170
3325 PPS 140	140	37.5	179	38	80	80	180
3325 PPS 150	150	40	185	38	80	80	200

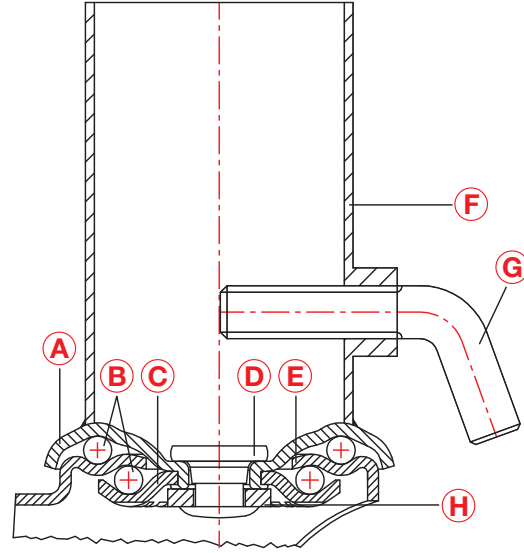

PPS		POLIAMİD TEKER MASURALI					
KOD NO	 mm	 mm	 mm	 mm	 mm	 mm	 kg
3325 PPS 064 F18	64	30	104	41	120	80	120
3325 PPS 080 F18	80	30	110	41	120	80	120
3325 PPS 100 F18	100	30	133	42	120	80	130
3325 PPS 125 F18	125	37.5	159	38	120	80	170
3325 PPS 140 F18	140	37.5	179	38	120	80	180
3325 PPS 150 F18	150	40	185	38	120	80	200

- A:** ÜST BİLYE KAPAĞI
- B:** KÜRESEL METAL TANE BİLYELER
- C:** ALT BİLYE ÇANAĞI
- D:** ÇANAK PERÇİNİ
- E:** OYNAK RULET MAŞASI
- F:** BORU
- G:** BORU AYAK SABİTLEME VİDASI
- H:** PUL



SLP		GALVANİZ KAPLI SAC ÜZERİ SİYAH KAUÇUK LASTİK KAPLAMA POLİAMİD BURÇLU						
KOD NO	mm	mm	mm	mm	mm	mm	kg	
3315 SLP 125	125	37.5	255	60	100	72	100	



SLP		GALVANİZ KAPLI SAC ÜZERİ SİYAH KAUÇUK LASTİK KAPLAMA POLİAMİD BURÇLU						
KOD NO	mm	mm	mm	mm	mm	mm	mm	kg
3315 SLP 125 F18	125	37.5	255	60	100	72	120	100

- A:** PASLANMAZ ÜST BİLYA KAPAĞI
B: PASLANMAZ KÜRESEL METAL TANE BİLYALAR
C: PASLANMAZ ALT BİLYA ÇANAĞI
D: PASLANMAZ BORU PERÇİNİ
E: PASLANMAZ OYNAK RULET MAŞASI

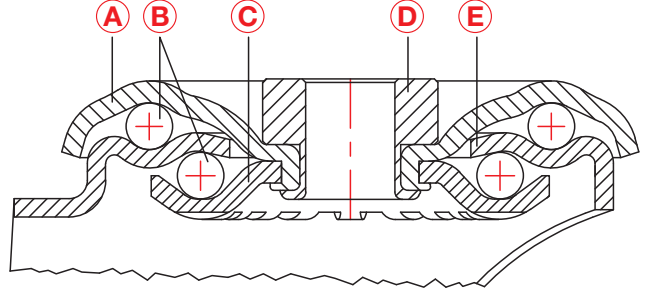

MLB		MOBLEN KASNAK ÜZERİ SİYAH DOLGU LASTİK KAPLAMA BURÇLU					
KOD NO	mm	mm	mm	mm	mm	kg	
S3300 MLB 080	80	25	113	41	12	50	
S3300 MLB 100	100	30	131	42	12	70	
S3300 MLB 125	125	37.5	156	38	12	100	
S3300 MLB 150	150	40	182	38	12	135	



MLB		MOBLEN KASNAK ÜZERİ SİYAH DOLGU LASTİK KAPLAMA BURÇLU					
KOD NO	mm	mm	mm	mm	mm	kg	
S3300 MLB 080 F18	80	25	113	41	121	50	
S3300 MLB 100 F18	100	30	131	42	121	70	
S3300 MLB 125 F18	125	37.5	156	38	121	100	
S3300 MLB 150 F18	150	40	182	38	121	135	









MTB		MOBLEN KASNAK ÜZERİ TERMOELASTİK KAPLAMA BURÇLU					
KOD NO	mm	mm	mm	mm	mm	kg	
S3300 MTB 080	80	30	113	41	12	80	
S3300 MTB 100	100	30	131	42	12	100	
S3300 MTB 125	125	37.5	156	38	12	120	
S3300 MTB 150	150	40	182	38	12	130	

* 150'LİK RULETİMİZDE SIRT KAPLAMASI İNCEDİR.









* 150'LİK RULETİMİZDE SIRT KAPLAMASI İNCEDİR.







MTB
MOBLEN KASNAK ÜZERİ TERMOELASTİK KAPLAMA BURÇLU

KOD NO	 mm	 mm	 mm	 mm	 mm	 mm	 kg
S3300 MTB 080 F18	80	30	113	41	121	12	80
S3300 MTB 100 F18	100	30	131	42	121	12	100
S3300 MTB 125 F18	125	37.5	156	38	121	12	120
S3300 MTB 150 F18	150	40	182	38	121	12	130









MMB
MOBLEN TEKER BURÇLU

KOD NO	 mm	 mm	 mm	 mm	 mm	 mm	 kg
S3300 MMB 080	80	30	113	41	12	12	100
S3300 MMB 100	100	30	131	42	12	12	110
S3300 MMB 125	125	37.5	156	38	12	12	150
S3300 MMB 150	150	40	182	38	12	12	180









MMB
MOBLEN TEKER BURÇLU

KOD NO	 mm	 mm	 mm	 mm	 mm	 mm	 kg
S3300 MMB 080 F18	80	30	113	41	121	12	100
S3300 MMB 100 F18	100	30	131	42	121	12	110
S3300 MMB 125 F18	125	37.5	156	38	121	12	150
S3300 MMB 150 F18	150	40	182	38	121	12	180

PPB
POLİAMİD TEKER BURÇLU







KOD NO	 mm	 mm	 mm	 mm	 mm	 mm	 kg
S3300 PPB 080	80	30	113	41	12	12	120
S3300 PPB 100	100	30	131	42	12	12	130
S3300 PPB 125	125	37.5	156	38	12	12	170
S3300 PPB 150	150	40	182	38	12	12	200

PPB
POLİAMİD TEKER BURÇLU







KOD NO	 mm	 mm	 mm	 mm	 mm	 mm	 kg
S3300 PPB 080 F18	80	30	113	41	121	12	120
S3300 PPB 100 F18	100	30	131	42	121	12	130
S3300 PPB 125 F18	125	37.5	156	38	121	12	170
S3300 PPB 150 F18	150	40	182	38	121	12	200

S3300 Serisi (Paslanmaz)



PPS		POLİAMİD TEKER MASURALI					
KOD NO	 mm	 mm	 mm	 mm	 mm	 kg	
S3300 PPS 080	80	30	113	41	12	120	
S3300 PPS 100	100	30	131	42	12	130	
S3300 PPS 125	125	37.5	156	38	12	170	
S3300 PPS 150	150	40	182	38	12	200	



PPS		POLİAMİD TEKER MASURALI					
KOD NO	 mm	 mm	 mm	 mm	 mm	 kg	
S3300 PPS 080 F18	80	30	113	41	121	120	
S3300 PPS 100 F18	100	30	131	42	121	130	
S3300 PPS 125 F18	125	37.5	156	38	121	170	
S3300 PPS 150 F18	150	40	182	38	121	200	







PRB		POLİAMİD KASNAK ÜZERİ MAVİ KAUKÇUK LASTİK KAPLAMA BURÇLU					
KOD NO	 mm	 mm	 mm	 mm	 mm	 kg	
S3300 PRB 080	80	32	113	41	12	80	
S3300 PRB 100	100	36	131	42	12	120	
S3300 PRB 125	125	36	156	38	12	150	



PRB		POLİAMİD KASNAK ÜZERİ MAVİ KAUKÇUK LASTİK KAPLAMA BURÇLU					
KOD NO	 mm	 mm	 mm	 mm	 mm	 kg	
S3300 PRB 080 F18	80	32	113	41	121	80	
S3300 PRB 100 F18	100	36	131	42	121	120	
S3300 PRB 125 F18	125	36	156	38	121	150	









PUB		POLİAMİD KASNAK ÜZERİ POLİÜRETAN KAPLAMA BURÇLU					
KOD NO	 mm	 mm	 mm	 mm	 mm	 kg	
S3300 PUB 080	80	30	113	41	12	125	
S3300 PUB 100	100	30	131	42	12	150	
S3300 PUB 125	125	35	156	38	12	180	
S3300 PUB 150	150	40	182	38	12	350	

* 150'LİK RULETİMİZDE SIRT KAPLAMASI İNCEDİR.



* 150'LİK RULETİMİZDE SIRT
KAPLAMASI İNCEDİR.

PUB		POLİAMİD KASNAK ÜZERİ POLİÜRETAN KAPLAMA BURÇLU					
KOD NO	 mm	 mm	 mm	 mm	 mm	 mm	 kg
S3300 PUB 080 F18	80	30	113	41	121	12	125
S3300 PUB 100 F18	100	30	131	42	121	12	150
S3300 PUB 125 F18	125	35	156	38	121	12	180
S3300 PUB 150 F18	150	40	182	38	121	12	350

- A:** PASLANMAZ BAĞLANTI TABLASI
- B:** BİLYA MUHAFAZA TOZLUĞU
- C:** KÜRESEL METAL TANE BİLYALAR
- D:** PASLANMAZ OYNAK RULET MAŞASI
- E:** PASLANMAZ ALT BİLYA ÇANAĞI
- F:** PASLANMAZ TABLA PERÇİNİ
- G:** PASLANMAZ PUL

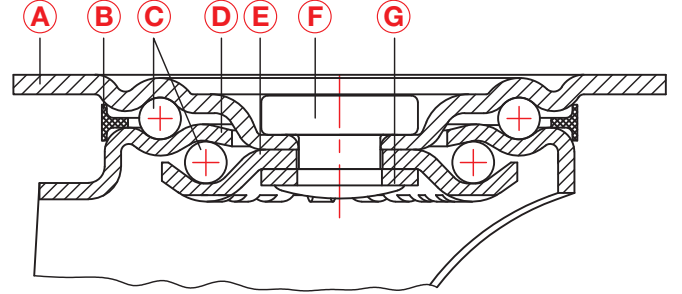

MLB		MOBLEN KASNAK ÜZERİ SİYAH DOLGU LASTİK KAPLAMA BURÇLU						
KOD NO								
	mm	mm	mm	mm	mm	mm	mm	kg
S3302 MLB 080	80	25	114	41	100x85	80x60	17x9	50
S3302 MLB 100	100	30	132	42	100x85	80x60	17x9	70
S3302 MLB 125	125	37.5	157	38	100x85	80x60	17x9	100
S3302 MLB 150	150	40	183	38	100x85	80x60	17x9	125



MLB		MOBLEN KASNAK ÜZERİ SİYAH DOLGU LASTİK KAPLAMA BURÇLU							
KOD NO									
	mm	mm	mm	mm	mm	mm	mm	mm	kg
S3302 MLB 080 F18	80	25	114	41	110	100x85	80x60	17x9	50
S3302 MLB 100 F18	100	30	132	42	110	100x85	80x60	17x9	70
S3302 MLB 125 F18	125	37.5	157	38	110	100x85	80x60	17x9	100
S3302 MLB 150 F18	150	40	183	38	110	100x85	80x60	17x9	125



MTB		MOBLEN KASNAK ÜZERİ TERMOELASTİK KAPLAMA BURÇLU						
KOD NO								
	mm	mm	mm	mm	mm	mm	mm	kg
S3302 MTB 080	80	30	114	41	100x85	80x60	17x9	80
S3302 MTB 100	100	30	132	42	100x85	80x60	17x9	100
S3302 MTB 125	125	37.5	157	38	100x85	80x60	17x9	120
S3302 MTB 150	150	40	183	38	100x85	80x60	17x9	130

* 150'LİK RULETİMİZDE SIRT KAPLAMASI İNCE DİR.



* 150'LİK RULETİMİZDE SIRT KAPLAMASI İNCEDİR.



MTB

MOBLEN KASNAK ÜZERİ TERMOELASTİK KAPLAMA BURÇLU

KOD NO									
	mm	mm	mm	mm	mm	mm	mm	mm	kg
S3302 MTB 080 F18	80	30	114	41	110	100x85	80x60	17x9	80
S3302 MTB 100 F18	100	30	132	42	110	100x85	80x60	17x9	100
S3302 MTB 125 F18	125	37.5	157	38	110	100x85	80x60	17x9	120
S3302 MTB 150 F18	150	40	183	38	110	100x85	80x60	17x9	130

MMB

MOBLEN TEKER BURÇLU

KOD NO									
	mm	mm	mm	mm	mm	mm	mm	mm	kg
S3302 MMB 080	80	30	114	41	100x85	80x60	17x9		100
S3302 MMB 100	100	30	132	42	100x85	80x60	17x9		110
S3302 MMB 125	125	37.5	157	38	100x85	80x60	17x9		150
S3302 MMB 150	150	40	183	38	100x85	80x60	17x9		180

MMB

MOBLEN TEKER BURÇLU

KOD NO									
	mm	mm	mm	mm	mm	mm	mm	mm	kg
S3302 MMB 080 F18	80	30	114	41	110	100x85	80x60	17x9	100
S3302 MMB 100 F18	100	30	132	42	110	100x85	80x60	17x9	110
S3302 MMB 125 F18	125	37.5	157	38	110	100x85	80x60	17x9	150
S3302 MMB 150 F18	150	40	183	38	110	100x85	80x60	17x9	180

PPB

POLİAMİD TEKER BURÇLU

KOD NO									
	mm	mm	mm	mm	mm	mm	mm	mm	kg
S3302 PPB 080	80	30	114	41	100x85	80x60	17x9		120
S3302 PPB 100	100	30	132	42	100x85	80x60	17x9		130
S3302 PPB 125	125	37.5	157	38	100x85	80x60	17x9		170
S3302 PPB 150	150	40	183	38	100x85	80x60	17x9		200

PPB

POLİAMİD TEKER BURÇLU

KOD NO									
	mm	mm	mm	mm	mm	mm	mm	mm	kg
S3302 PPB 080 F18	80	30	114	41	110	100x85	80x60	17x9	120
S3302 PPB 100 F18	100	30	132	42	110	100x85	80x60	17x9	130
S3302 PPB 125 F18	125	37.5	157	38	110	100x85	80x60	17x9	170
S3302 PPB 150 F18	150	40	183	38	110	100x85	80x60	17x9	200





PRB		POLİAMİD KASNAK ÜZERİ MAVİ KAUÇUK LASTİK KAPLAMA BURÇLU						
KOD NO	 mm	 mm	 mm	 mm	 mm	 mm	 mm	kg
S3302 PRB 080	80	32	114	41	100x85	80x60	17x9	80
S3302 PRB 100	100	36	132	42	100x85	80x60	17x9	120
S3302 PRB 125	125	36	157	38	100x85	80x60	17x9	150











PRB		POLİAMİD KASNAK ÜZERİ MAVİ KAUÇUK LASTİK KAPLAMA BURÇLU							
KOD NO	 mm	 mm	 mm	 mm	 mm	 mm	 mm	 mm	kg
S3302 PRB 080 F18	80	32	114	41	110	100x85	80x60	17x9	80
S3302 PRB 100 F18	100	36	132	42	110	100x85	80x60	17x9	120
S3302 PRB 125 F18	125	36	157	38	110	100x85	80x60	17x9	150



PUB		POLİAMİD KASNAK ÜZERİ POLİÜRETAN KAPLAMA BURÇLU						
KOD NO	 mm	 mm	 mm	 mm	 mm	 mm	 mm	kg
S3302 PUB 080	80	30	114	41	100x85	80x60	17x9	125
S3302 PUB 100	100	30	132	42	100x85	80x60	17x9	150
S3302 PUB 125	125	35	157	38	100x85	80x60	17x9	180
S3302 PUB 150	150	40	183	38	100x85	80x60	17x9	350

* 150'LİK RULETİMİZDE SIRT KAPLAMASI İNCE DİR.



PUB		POLİAMİD KASNAK ÜZERİ POLİÜRETAN KAPLAMA BURÇLU							
KOD NO	 mm	 mm	 mm	 mm	 mm	 mm	 mm	 mm	kg
S3302 PUB 080 F18	80	30	114	41	110	100x85	80x60	17x9	125
S3302 PUB 100 F18	100	30	132	42	110	100x85	80x60	17x9	150
S3302 PUB 125 F18	125	35	157	38	110	100x85	80x60	17x9	180
S3302 PUB 150 F18	150	40	183	38	110	100x85	80x60	17x9	350

- A:** PASLANMAZ BAĞLANTI PİMİ
- B:** PASLANMAZ ÜST BİLYA KAPAĞI
- C:** KÜRESEL METAL TANE BİLYALAR
- D:** PASLANMAZ OYNAK RULET MAŞASI
- E:** PASLANMAZ ALT BİLYA ÇANAĞI
- F:** PASLANMAZ MONTAJ PULU

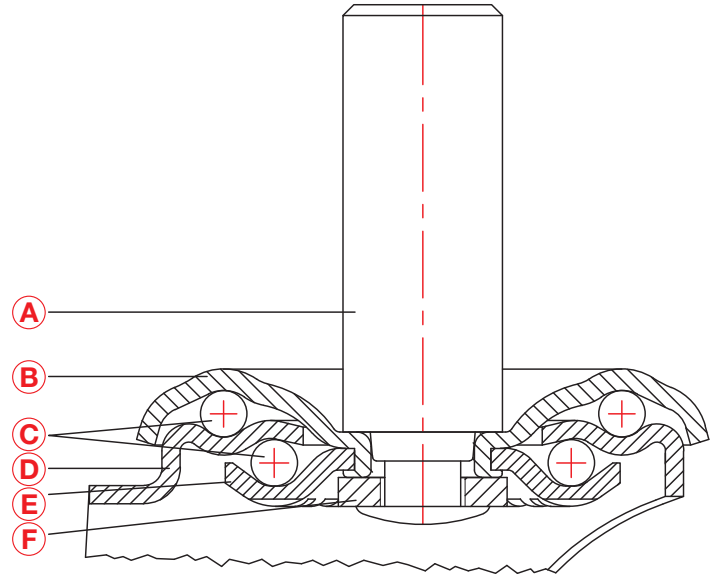

MLB		MOBLEN KASNAK ÜZERİ SİYAH DOLGU LASTİK KAPLAMA BURÇLU					
KOD NO	mm	mm	mm	mm	mm	mm	kg
S3305 MLB 080	80	25	113	41	22	50	50
S3305 MLB 100	100	30	131	42	22	50	70
S3305 MLB 125	125	37.5	156	38	22	50	100
S3305 MLB 150	150	40	182	38	22	50	125



MLB		MOBLEN KASNAK ÜZERİ SİYAH DOLGU LASTİK KAPLAMA BURÇLU					
KOD NO	mm	mm	mm	mm	mm	mm	kg
S3305 MLB 080 F18	80	25	113	41	121	22	50
S3305 MLB 100 F18	100	30	131	42	121	22	70
S3305 MLB 125 F18	125	37.5	156	38	121	22	100
S3305 MLB 150 F18	150	40	182	38	121	22	125



MTB		MOBLEN KASNAK ÜZERİ TERMOELASTİK KAPLAMA BURÇLU					
KOD NO	mm	mm	mm	mm	mm	mm	kg
S3305 MTB 080	80	30	113	41	22	50	80
S3305 MTB 100	100	30	131	42	22	50	100
S3305 MTB 125	125	37.5	156	38	22	50	120
S3305 MTB 150	150	40	182	38	22	50	130

* 150'LİK RULETİMİZDE SIRT KAPLAMASI İNCE DİR.









S3305 Serisi (Paslanmaz)



* 150'LİK RULETİMİZDE SIRT KAPLAMASI İNCE DİR.

MTB









MOBLEN KASNAK ÜZERİ TERMOELASTİK KAPLAMA BURÇLU

KOD NO								
	mm	mm	mm	mm	mm	mm	mm	kg
S3305 MTB 080 F18	80	30	113	41	121	22	50	80
S3305 MTB 100 F18	100	30	131	42	121	22	50	100
S3305 MTB 125 F18	125	37.5	156	38	121	22	50	120
S3305 MTB 150 F18	150	40	182	38	121	22	50	130



MMB









MOBLEN TEKER BURÇLU

KOD NO								
	mm	mm	mm	mm	mm	mm	mm	kg
S3305 MMB 080	80	30	113	41	22	50	100	100
S3305 MMB 100	100	30	131	42	22	50	110	110
S3305 MMB 125	125	37.5	156	38	22	50	150	150
S3305 MMB 150	150	40	182	38	22	50	180	180



MMB









MOBLEN TEKER BURÇLU

KOD NO								
	mm	mm	mm	mm	mm	mm	mm	kg
S3305 MMB 080 F18	80	30	113	41	121	22	50	100
S3305 MMB 100 F18	100	30	131	42	121	22	50	110
S3305 MMB 125 F18	125	37.5	156	38	121	22	50	150
S3305 MMB 150 F18	150	40	182	38	121	22	50	180



PPB









POLİAMİD TEKER BURÇLU

KOD NO								
	mm	mm	mm	mm	mm	mm	mm	kg
S3305 PPB 080	80	30	113	41	22	50	120	120
S3305 PPB 100	100	30	131	42	22	50	130	130
S3305 PPB 125	125	37.5	156	38	22	50	170	170
S3305 PPB 150	150	40	182	38	22	50	200	200









PPB





POLİAMİD TEKER BURÇLU

KOD NO								
	mm	mm	mm	mm	mm	mm	mm	kg
S3305 PPB 080 F18	80	30	113	41	121	22	50	120
S3305 PPB 100 F18	100	30	131	42	121	22	50	130
S3305 PPB 125 F18	125	37.5	156	38	121	22	50	170
S3305 PPB 150 F18	150	40	182	38	121	22	50	200









PRB		POLİAMİD KASNAK ÜZERİ MAVİ KAUÇUK LASTİK KAPLAMA BURÇLU						
KOD NO								
	mm	mm	mm	mm	mm	mm	kg	
S3305 PRB 080	80	32	113	41	22	50	80	
S3305 PRB 100	100	36	131	42	22	50	120	
S3305 PRB 125	125	36	156	38	22	50	150	











PRB		POLİAMİD KASNAK ÜZERİ MAVİ KAUÇUK LASTİK KAPLAMA BURÇLU						
KOD NO								
	mm	mm	mm	mm	mm	mm	mm	kg
S3305 PRB 080 F18	80	32	113	41	121	22	50	80
S3305 PRB 100 F18	100	36	131	42	121	22	50	120
S3305 PRB 125 F18	125	36	156	38	121	22	50	150



PUB		POLİAMİD KASNAK ÜZERİ POLİÜRETAN KAPLAMA BURÇLU						
KOD NO								
	mm	mm	mm	mm	mm	mm	kg	
S3305 PUB 080	80	30	113	41	22	50	125	
S3305 PUB 100	100	30	131	42	22	50	150	
S3305 PUB 125	125	35	156	38	22	50	180	
S3305 PUB 150	150	40	182	38	22	50	400	

* 150'LİK RULETİMİZDE SIRT KAPLAMASI İNÇEDİR.



PUB		POLİAMİD KASNAK ÜZERİ POLİÜRETAN KAPLAMA BURÇLU						
KOD NO								
	mm	mm	mm	mm	mm	mm	mm	kg
S3305 PUB 080 F18	80	30	113	41	121	22	50	125
S3305 PUB 100 F18	100	30	131	42	121	22	50	150
S3305 PUB 125 F18	125	35	156	38	121	22	50	180
S3305 PUB 150 F18	150	40	182	38	121	22	50	400

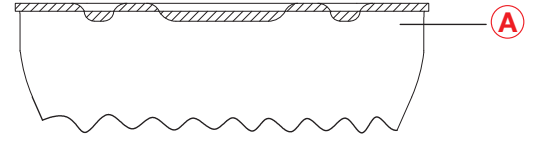

A: PASLANMAZ SABİT MAŞA

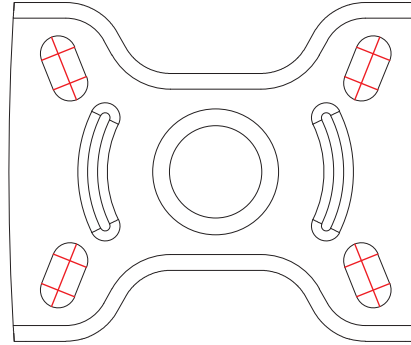

MLB

MOBLEN KASNAK ÜZERİ SİYAH DOLGU LASTİK KAPLAMA BURÇLU

KOD NO	mm	mm	mm	mm	mm	mm	kg
S3307 MLB 080	80	25	114	100x86	80x61	17x9	50
S3307 MLB 100	100	30	132	100x86	80x61	17x9	70
S3307 MLB 125	125	37.5	159	105x86	80x61	17x9	100
S3307 MLB 150	150	40	183	105x86	80x61	17x9	125



MTB

MOBLEN KASNAK ÜZERİ TERMOELASTİK KAPLAMA BURÇLU

KOD NO	mm	mm	mm	mm	mm	mm	kg
S3307 MTB 080	80	30	114	100x86	80x61	17x9	80
S3307 MTB 100	100	30	132	100x86	80x61	17x9	100
S3307 MTB 125	125	37.5	159	105x86	80x61	17x9	120
S3307 MTB 150	150	40	183	105x86	80x61	17x9	130

* 150'LİK RULETİMİZDE SIRT KAPLAMASI İNCEDİR.









MMB

MOBLEN TEKER BURÇLU

KOD NO	mm	mm	mm	mm	mm	mm	kg
S3307 MMB 080	80	30	114	100x86	80x61	17x9	100
S3307 MMB 100	100	30	132	100x86	80x61	17x9	110
S3307 MMB 125	125	37.5	159	105x86	80x61	17x9	150
S3307 MMB 150	150	40	183	105x86	80x61	17x9	180









PPB		POLİAMİD TEKER BURÇLU						
KOD NO	 mm	 mm	 mm	 mm	 mm	 mm	 kg	
S3307 PPB 080	80	30	114	100x86	80x61	17x9	120	
S3307 PPB 100	100	30	132	100x86	80x61	17x9	130	
S3307 PPB 125	125	37.5	159	105x86	80x61	17x9	170	
S3307 PPB 150	150	40	183	105x86	80x61	17x9	200	



PRB		POLİAMİD KASNAK ÜZERİ MAVİ KAUÇUK LASTİK KAPLAMA BURÇLU						
KOD NO	 mm	 mm	 mm	 mm	 mm	 mm	 kg	
S3307 PRB 080	80	32	114	100x86	80x61	17x9	80	
S3307 PRB 100	100	36	132	100x86	80x61	17x9	120	
S3307 PRB 125	125	36	159	105x86	80x61	17x9	150	



PUB		POLİAMİD KASNAK ÜZERİ POLİÜRETAN KAPLAMA BURÇLU						
KOD NO	 mm	 mm	 mm	 mm	 mm	 mm	 kg	
S3307 PUB 080	80	30	114	100x86	80x61	17x9	125	
S3307 PUB 100	100	30	132	100x86	80x61	17x9	150	
S3307 PUB 125	125	35	159	105x86	80x61	17x9	180	
S3307 PUB 150	150	40	183	105x86	80x61	17x9	350	

* 150'LİK RULETİMİZDE SIRT KAPLAMASI İNCEDİR.

- A:** PASLANMAZ İMBUS CİVATA
- B:** PASLANMAZ KARE SOMUN
- C:** SOKET VE SOMUN ALTI TAKVİYELİ PLASTİK
- D:** SOKET
- E:** PLASTİK BORU PERÇİNİ
- F:** PASLANMAZ ÜST BİLYA KAPAĞI
- G:** KÜRESEL METAL TANE BİLYALAR
- H:** PASLANMAZ OYNAK RULET MAŞA
- I:** PASLANMAZ ALT BİLYA ÇANAĞI
- J:** PASLANMAZ MONTAJ PULU

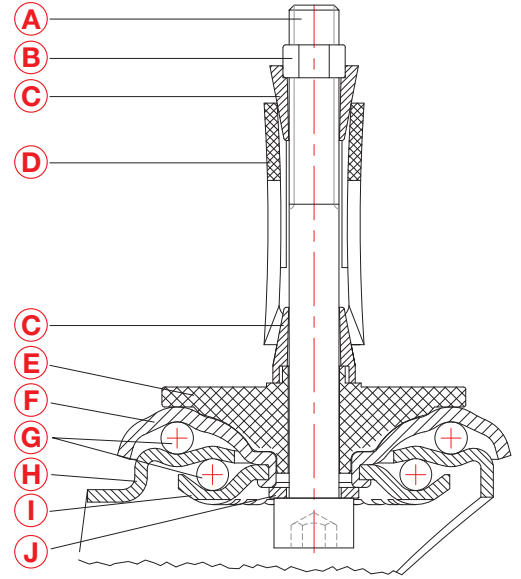

MLB		MOBLEN KASNAK ÜZERİ SİYAH DOLGU LASTİK KAPLAMA BURÇLU					
KOD NO	mm	mm	mm	mm	mm	kg	
S3325 MLB 080	80	25	117	41	80	50	
S3325 MLB 100	100	30	135	42	80	70	
S3325 MLB 125	125	37.5	160	38	80	100	
S3325 MLB 150	150	40	186	38	80	125	



MLB		MOBLEN KASNAK ÜZERİ SİYAH DOLGU LASTİK KAPLAMA BURÇLU					
KOD NO	mm	mm	mm	mm	mm	kg	
S3325 MLB 080 F18	80	25	117	41	121	50	
S3325 MLB 100 F18	100	30	135	42	121	70	
S3325 MLB 125 F18	125	37.5	160	38	121	100	
S3325 MLB 150 F18	150	40	186	38	121	125	



MTB		MOBLEN KASNAK ÜZERİ TERMOELASTİK KAPLAMA BURÇLU					
KOD NO	mm	mm	mm	mm	mm	kg	
S3325 MTB 080	80	30	117	41	80	80	
S3325 MTB 100	100	30	135	42	80	100	
S3325 MTB 125	125	37.5	160	38	80	120	
S3325 MTB 150	150	40	186	38	80	130	

* 150'LİK RULETİMİZDE SIRT KAPLAMASI İNCE DİR.



* 150'LİK RULETİMİZDE SIRT KAPLAMASI İNCE DİR.

MTB		MOBLEN KASNAK ÜZERİ TERMOELASTİK KAPLAMA BURÇLU					
KOD NO	mm	mm	mm	mm	mm	mm	kg
S3325 MTB 080 F18	80	30	117	41	121	80	80
S3325 MTB 100 F18	100	30	135	42	121	80	100
S3325 MTB 125 F18	125	37.5	160	38	121	80	120
S3325 MTB 150 F18	150	40	186	38	121	80	130



MMB		MOBLEN TEKER BURÇLU					
KOD NO	mm	mm	mm	mm	mm	mm	kg
S3325 MMB 080	80	30	117	41	80	100	100
S3325 MMB 100	100	30	135	42	80	110	110
S3325 MMB 125	125	37.5	160	38	80	150	150
S3325 MMB 150	150	40	186	38	80	180	180









MMB		MOBLEN TEKER BURÇLU					
KOD NO	mm	mm	mm	mm	mm	mm	kg
S3325 MMB 080 F18	80	30	117	41	121	80	100
S3325 MMB 100 F18	100	30	135	42	121	80	110
S3325 MMB 125 F18	125	37.5	160	38	121	80	150
S3325 MMB 150 F18	150	40	186	38	121	80	180



PPB		POLİAMİD TEKER BURÇLU					
KOD NO	mm	mm	mm	mm	mm	mm	kg
S3325 PPB 080	80	30	117	41	80	120	120
S3325 PPB 100	100	30	135	42	80	130	130
S3325 PPB 125	125	37.5	160	38	80	170	170
S3325 PPB 150	150	40	186	38	80	200	200



PPB		POLİAMİD TEKER BURÇLU					
KOD NO	 mm	 mm	 mm	 mm	 mm	 mm	 kg
S3325 PPB 080 F18	80	30	117	41	121	80	120
S3325 PPB 100 F18	100	30	135	42	121	80	130
S3325 PPB 125 F18	125	37.5	160	38	121	80	170
S3325 PPB 150 F18	150	40	186	38	121	80	200









PRB		POLİAMİD KASNAK ÜZERİ MAVİ KAÜÇÜK LASTİK KAPLAMA BURÇLU					
KOD NO	 mm	 mm	 mm	 mm	 mm	 mm	 kg
S3325 PRB 080	80	32	117	41	80	80	80
S3325 PRB 100	100	36	135	42	80	120	120
S3325 PRB 125	125	36	160	38	80	150	150



PRB		POLİAMİD KASNAK ÜZERİ MAVİ KAÜÇÜK LASTİK KAPLAMA BURÇLU					
KOD NO	 mm	 mm	 mm	 mm	 mm	 mm	 kg
S3325 PRB 080 F18	80	32	117	41	121	80	80
S3325 PRB 100 F18	100	36	135	42	121	80	120
S3325 PRB 125 F18	125	36	160	38	121	80	150









PUB		POLİAMİD KASNAK ÜZERİ POLİÜRETAN KAPLAMA BURÇLU					
KOD NO	 mm	 mm	 mm	 mm	 mm	 mm	 kg
S3325 PUB 080	80	30	117	41	80	125	125
S3325 PUB 100	100	30	135	42	80	150	150
S3325 PUB 125	125	35	160	38	80	180	180
S3325 PUB 150	150	40	186	38	80	350	350

* 150'LİK RULETİMİZDE SIRT KAPLAMASI İNCEDİR.









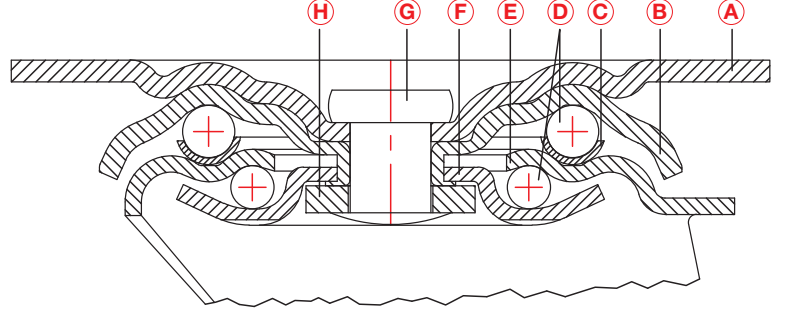

* 150'LİK RULETİMİZDE SIRT
KAPLAMASI İNCEDİR.









PUB		POLİAMİD KASNAK ÜZERİ POLİÜRETAN KAPLAMA BURÇLU					
KOD NO	 mm	 mm	 mm	 mm	 mm	 mm	 kg
S3325 PUB 080 F18	80	30	117	41	121	80	125
S3325 PUB 100 F18	100	30	135	42	121	80	150
S3325 PUB 125 F18	125	35	160	38	121	80	180
S3325 PUB 150 F18	150	40	186	38	121	80	350

- A:** OYNAK BAĞLANTI TABLASI
B: ÜST BİLYA KAPAĞI
C: CK60 MALZEMEDEN
 SERTLEŞTİRİLMİŞ BİLYA YATAĞI
D: KÜRESEL METAL TANE BİLYALAR
E: OYNAK RULET MAŞASI
F: ALT BİLYA ÇANAĞI
G: TABLA PERÇİNİ
H: MONTAJ PULU

**BBC****ISIYA DAYANIKLI BAKALİT TEKER PİRİNÇ BURÇLU (+250°C)**

KOD NO	 mm	 mm	 mm	 mm	 mm	 mm	 mm	 kg
3602 BBC 100	100	35	140	48	140x110	105x80	13.5x11	150
3602 BBC 125	125	40	166	49.5	140x110	105x80	13.5x11	200
3602 BBC 150	150	45	189	55	140x110	105x80	13.5x11	300
3602 BBC 200	200	50	239	52	140x110	105x80	13.5x11	500

**BBC****ISIYA DAYANIKLI BAKALİT TEKER PİRİNÇ BURÇLU (+250°C)**

KOD NO	 mm	 mm	 mm	 mm	 mm	 mm	 mm	 mm	 kg
3602 BBC 100 F18	100	35	140	48	156	140x110	105x80	13.5x11	150
3602 BBC 125 F18	125	40	166	49.5	156	140x110	105x80	13.5x11	200
3602 BBC 150 F18	150	45	189	55	156	140x110	105x80	13.5x11	300
3602 BBC 200 F18	200	50	239	52	143	140x110	105x80	13.5x11	500



CTB

GÜÇLENDİRİLMİŞ POLİAMİD KASNAK ÜZERİ TERMOELASTİK KAPLAMA BURÇLU

KOD NO	mm	mm	mm	mm	mm	mm	mm	kg
3602 CTB 100	100	35	140	48	140x110	105x80	13.5x11	120
3602 CTB 125	125	40	166	49.5	140x110	105x80	13.5x11	150
3602 CTB 150	150	45	189	55	140x110	105x80	13.5x11	180
3602 CTB 200	200	50	239	52	140x110	105x80	13.5x11	250



CTB

GÜÇLENDİRİLMİŞ POLİAMİD KASNAK ÜZERİ TERMOELASTİK KAPLAMA BURÇLU

KOD NO	mm	mm	mm	mm	mm	mm	mm	kg	
3602 CTB 100 F18	100	35	140	48	156	140x110	105x80	13.5x11	120
3602 CTB 125 F18	125	40	166	49.5	156	140x110	105x80	13.5x11	150
3602 CTB 150 F18	150	45	189	55	156	140x110	105x80	13.5x11	180
3602 CTB 200 F18	200	50	239	52	143	140x110	105x80	13.5x11	250



CTR

GÜÇLENDİRİLMİŞ POLİAMİD KASNAK ÜZERİ TERMOELASTİK KAPLAMA RULMANLI

KOD NO	mm	mm	mm	mm	mm	mm	mm	kg
3602 CTR 100	100	35	140	48	140x110	105x80	13.5x11	120
3602 CTR 125	125	40	166	49.5	140x110	105x80	13.5x11	150
3602 CTR 150	150	45	189	55	140x110	105x80	13.5x11	180
3602 CTR 200	200	50	239	52	140x110	105x80	13.5x11	250



CTR

GÜÇLENDİRİLMİŞ POLİAMİD KASNAK ÜZERİ TERMOELASTİK KAPLAMA RULMANLI

KOD NO	mm	mm	mm	mm	mm	mm	mm	kg	
3602 CTR 100 F18	100	35	140	48	156	140x110	105x80	13.5x11	120
3602 CTR 125 F18	125	40	166	49.5	156	140x110	105x80	13.5x11	150
3602 CTR 150 F18	150	45	189	55	156	140x110	105x80	13.5x11	180
3602 CTR 200 F18	200	50	239	52	143	140x110	105x80	13.5x11	250











DDB









DÖKÜM TEKER BURÇLU

KOD NO	mm	mm	mm	mm	mm	mm	mm	kg
3602 DDB 100	100	35	140	48	140x110	105x80	13.5x11	200
3602 DDB 125	125	40	166	49.5	140x110	105x80	13.5x11	250
3602 DDB 150	150	45	189	55	140x110	105x80	13.5x11	350
3602 DDB 200	200	50	239	52	140x110	105x80	13.5x11	500











DDB		DÖKÜM TEKER BURÇLU							
KOD NO									kg
3602 DDB 100 F18	100	35	140	48	156	140x110	105x80	13.5x11	200
3602 DDB 125 F18	125	40	166	49.5	156	140x110	105x80	13.5x11	250
3602 DDB 150 F18	150	45	189	55	156	140x110	105x80	13.5x11	350
3602 DDB 200 F18	200	50	239	52	143	140x110	105x80	13.5x11	500











DDR		DÖKÜM TEKER RULMANLI							
KOD NO									kg
3602 DDR 100	100	35	140	48	140x110	105x80	13.5x11	200	
3602 DDR 125	125	40	166	49.5	140x110	105x80	13.5x11	250	
3602 DDR 150	150	45	189	55	140x110	105x80	13.5x11	350	
3602 DDR 200	200	50	239	52	140x110	105x80	13.5x11	500	











DDR		DÖKÜM TEKER RULMANLI							
KOD NO									kg
3602 DDR 100 F18	100	35	140	48	156	140x110	105x80	13.5x11	200
3602 DDR 125 F18	125	40	166	49.5	156	140x110	105x80	13.5x11	250
3602 DDR 150 F18	150	45	189	55	156	140x110	105x80	13.5x11	350
3602 DDR 200 F18	200	50	239	52	143	140x110	105x80	13.5x11	500



DOR		DÖKÜM ÜZERİ DÖKME POLİÜRETAN KAPLAMA RULMANLI							
KOD NO									kg
3602 DOR 100	100	35	140	48	140x110	105x80	13.5x11	200	
3602 DOR 125	125	40	166	49.5	140x110	105x80	13.5x11	250	
3602 DOR 150	150	45	189	55	140x110	105x80	13.5x11	350	
3602 DOR 200	200	50	239	52	140x110	105x80	13.5x11	500	



DOR		DÖKÜM ÜZERİ DÖKME POLİÜRETAN KAPLAMA RULMANLI							
KOD NO									kg
3602 DOR 100 F18	100	35	140	48	156	140x110	105x80	13.5x11	200
3602 DOR 125 F18	125	40	166	49.5	156	140x110	105x80	13.5x11	250
3602 DOR 150 F18	150	45	189	55	156	140x110	105x80	13.5x11	350
3602 DOR 200 F18	200	50	239	52	143	140x110	105x80	13.5x11	500



RMB		AĞIR TİP MOBLEN TEKER BURÇLU						
KOD NO								
	mm	mm	mm	mm	mm	mm	mm	kg
3602 RMB 100	100	35	140	48	140x110	105x80	13.5x11	200
3602 RMB 125	125	40	166	49.5	140x110	105x80	13.5x11	250
3602 RMB 150	150	45	189	55	140x110	105x80	13.5x11	350
3602 RMB 200	200	50	239	52	140x110	105x80	13.5x11	500



RMB		AĞIR TİP MOBLEN TEKER BURÇLU							
KOD NO									
	mm	mm	mm	mm	mm	mm	mm	mm	kg
3602 RMB 100 F18	100	35	140	48	156	140x110	105x80	13.5x11	200
3602 RMB 125 F18	125	40	166	49.5	156	140x110	105x80	13.5x11	250
3602 RMB 150 F18	150	45	189	55	156	140x110	105x80	13.5x11	350
3602 RMB 200 F18	200	50	239	52	143	140x110	105x80	13.5x11	500



RPB		AĞIR TİP POLİAMİD TEKER BURÇLU						
KOD NO								
	mm	mm	mm	mm	mm	mm	mm	kg
3602 RPB 100	100	35	140	48	140x110	105x80	13.5x11	200
3602 RPB 125	125	40	166	49.5	140x110	105x80	13.5x11	250
3602 RPB 150	150	45	189	55	140x110	105x80	13.5x11	350
3602 RPB 200	200	50	239	52	140x110	105x80	13.5x11	500











RPB		AĞIR TİP POLİAMİD TEKER BURÇLU							
KOD NO									
	mm	mm	mm	mm	mm	mm	mm	mm	kg
3602 RPB 100 F18	100	35	140	48	156	140x110	105x80	13.5x11	200
3602 RPB 125 F18	125	40	166	49.5	156	140x110	105x80	13.5x11	250
3602 RPB 150 F18	150	45	189	55	156	140x110	105x80	13.5x11	350
3602 RPB 200 F18	200	50	239	52	143	140x110	105x80	13.5x11	500



RPR		AĞIR TİP POLİAMİD TEKER RULMANLI						
KOD NO								
	mm	mm	mm	mm	mm	mm	mm	kg
3602 RPR 100	100	35	140	48	140x110	105x80	13.5x11	200
3602 RPR 125	125	40	166	49.5	140x110	105x80	13.5x11	250
3602 RPR 150	150	45	189	55	140x110	105x80	13.5x11	350
3602 RPR 200	200	50	239	52	140x110	105x80	13.5x11	500



RPR		AĞIR TİP POLİAMİD TEKER RULMANLI							
KOD NO									
	mm	mm	mm	mm	mm	mm	mm	mm	kg
3602 RPR 100 F18	100	35	140	48	156	140x110	105x80	13.5x11	200
3602 RPR 125 F18	125	40	166	49.5	156	140x110	105x80	13.5x11	250
3602 RPR 150 F18	150	45	189	55	156	140x110	105x80	13.5x11	350
3602 RPR 200 F18	200	50	239	52	143	140x110	105x80	13.5x11	500



C2UR		GÜÇLENDİRİLMİŞ POLİAMİD KASNAK ÜZERİ POLİÜRETAN KAPLAMA RULMANLI							
KOD NO									
	mm	mm	mm	mm	mm	mm	mm	mm	kg
3602 C2UR 150	150	45	189	55	140x110	105x80	13.5x11		400



C2UR		GÜÇLENDİRİLMİŞ POLİAMİD KASNAK ÜZERİ POLİÜRETAN KAPLAMA RULMANLI							
KOD NO									
	mm	mm	mm	mm	mm	mm	mm	mm	kg
3602 C2UR 150 F18	150	45	189	55	156	140x110	105x80	13.5x11	400

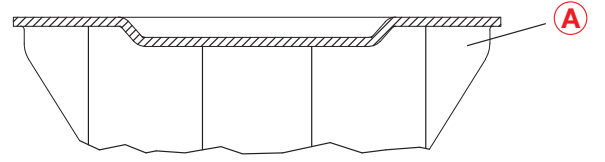

A: SABİT MAŞA

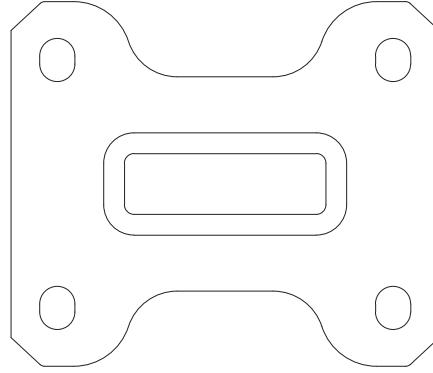

BBC		ISIYA DAYANIKLI BAKALİT TEKER PİRİNÇ BURÇLU (+250°C)					
KOD NO	mm	mm	mm	mm	mm	mm	kg
3607 BBC 100	100	35	140	134x114	105x80	13.5x11	150
3607 BBC 125	125	40	166	134x114	105x80	13.5x11	200
3607 BBC 150	150	45	189	134x114	105x80	13.5x11	300
3607 BBC 200	200	50	239	134x114	105x80	13.5x11	500







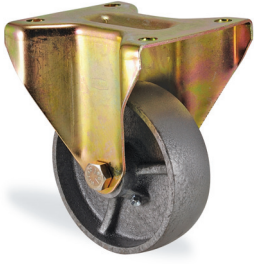

CTB		GÜÇLENDİRİLMİŞ POLİAMİD KASNAK ÜZERİ TERMOELASTİK KAPLAMA BURÇLU					
KOD NO	mm	mm	mm	mm	mm	mm	kg
3607 CTB 100	100	35	140	134x114	105x80	13.5x11	120
3607 CTB 125	125	40	166	134x114	105x80	13.5x11	150
3607 CTB 150	150	45	189	134x114	105x80	13.5x11	180
3607 CTB 200	200	50	239	134x114	105x80	13.5x11	250







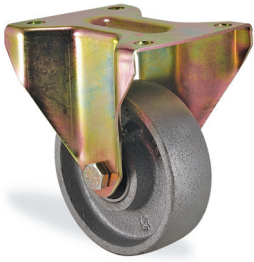

CTR		GÜÇLENDİRİLMİŞ POLİAMİD KASNAK ÜZERİ TERMOELASTİK KAPLAMA RULMANLI					
KOD NO	mm	mm	mm	mm	mm	mm	kg
3607 CTR 100	100	35	140	134x114	105x80	13.5x11	120
3607 CTR 125	125	40	166	134x114	105x80	13.5x11	150
3607 CTR 150	150	45	189	134x114	105x80	13.5x11	180
3607 CTR 200	200	50	239	134x114	105x80	13.5x11	250









DDB		DÖKÜM TEKER BURÇLU					
KOD NO	 mm	 mm	 mm	 mm	 mm	 mm	kg
3607 DDB 100	100	35	140	134x114	105x80	13.5x11	200
3607 DDB 125	125	40	166	134x114	105x80	13.5x11	250
3607 DDB 150	150	45	189	134x114	105x80	13.5x11	350
3607 DDB 200	200	50	239	134x114	105x80	13.5x11	500









DDR		DÖKÜM TEKER RULMANLI					
KOD NO	 mm	 mm	 mm	 mm	 mm	 mm	kg
3607 DDR 100	100	35	140	134x114	105x80	13.5x11	200
3607 DDR 125	125	40	166	134x114	105x80	13.5x11	250
3607 DDR 150	150	45	189	134x114	105x80	13.5x11	350
3607 DDR 200	200	50	239	134x114	105x80	13.5x11	500



DOR		DÖKÜM ÜZERİ DÖKME POLİÜRETAN KAPLAMA RULMANLI					
KOD NO	 mm	 mm	 mm	 mm	 mm	 mm	kg
3607 DOR 100	100	35	140	134x114	105x80	13.5x11	200
3607 DOR 125	125	40	166	134x114	105x80	13.5x11	250
3607 DOR 150	150	45	189	134x114	105x80	13.5x11	350
3607 DOR 200	200	50	239	134x114	105x80	13.5x11	500



D2OR		DÖKÜM ÜZERİ OVAL DÖKME POLİÜRETAN KAPLAMA RULMANLI					
KOD NO	 mm	 mm	 mm	 mm	 mm	 mm	kg
3607 D2OR 100	100	35	140	134x114	105x80	13.5x11	200
3607 D2OR 125	125	40	166	134x114	105x80	13.5x11	250
3607 D2OR 150	150	45	189	134x114	105x80	13.5x11	350
3607 D2OR 200	200	50	239	134x114	105x80	13.5x11	500







DYR		DÖKÜM ÜZERİ VULKANİZE LASTİK KAPLAMA RULMANLI					
KOD NO	 mm	 mm	 mm	 mm	 mm	 mm	kg
3607 DYR 100	100	35	140	134x114	105x80	13.5x11	140
3607 DYR 125	125	40	166	134x114	105x80	13.5x11	180
3607 DYR 150	150	45	189	134x114	105x80	13.5x11	200
3607 DYR 200	200	50	239	134x114	105x80	13.5x11	320







KYR		KAMALON KASNAK ÜZERİ VULKANİZE SİYAH LASTİK KAPLAMA RULMANLI					
KOD NO							
	mm	mm	mm	mm	mm	mm	kg
3607 KYR 100	100	40	140	134x114	105x80	13.5x11	140
3607 KYR 125	125	40	166	134x114	105x80	13.5x11	180
3607 KYR 150	150	45	189	134x114	105x80	13.5x11	200
3607 KYR 200	200	50	239	134x114	105x80	13.5x11	320









PUB		POLİAMİD KASNAK ÜZERİ POLİÜRETAN KAPLAMA BURÇLU					
KOD NO							
	mm	mm	mm	mm	mm	mm	kg
3607 PUB 100	100	35	140	134x114	105x80	13.5x11	200
3607 PUB 125	125	40	166	134x114	105x80	13.5x11	250
3607 PUB 150	150	45	189	134x114	105x80	13.5x11	350
3607 PUB 200	200	50	239	134x114	105x80	13.5x11	500









PUR		POLİAMİD KASNAK ÜZERİ POLİÜRETAN KAPLAMA RULMANLI					
KOD NO							
	mm	mm	mm	mm	mm	mm	kg
3607 PUR 100	100	35	140	134x114	105x80	13.5x11	200
3607 PUR 125	125	40	166	134x114	105x80	13.5x11	250
3607 PUR 150	150	45	189	134x114	105x80	13.5x11	350
3607 PUR 200	200	50	239	134x114	105x80	13.5x11	500









RMB		AĞIR TİP MOBLEN TEKER BURÇLU					
KOD NO							
	mm	mm	mm	mm	mm	mm	kg
3607 RMB 100	100	35	140	134x114	105x80	13.5x11	200
3607 RMB 125	125	40	166	134x114	105x80	13.5x11	250
3607 RMB 150	150	45	189	134x114	105x80	13.5x11	350
3607 RMB 200	200	50	239	134x114	105x80	13.5x11	500



RPB		AĞIR TİP POLİAMİD TEKER BURÇLU					
KOD NO							
	mm	mm	mm	mm	mm	mm	kg
3607 RPB 100	100	35	140	134x114	105x80	13.5x11	200
3607 RPB 125	125	40	166	134x114	105x80	13.5x11	250
3607 RPB 150	150	45	189	134x114	105x80	13.5x11	350
3607 RPB 200	200	50	239	134x114	105x80	13.5x11	500









RPR AĞIR TİP POLİAMİD TEKER RULMANLI

KOD NO	 mm	 mm	 mm	 mm	 mm	 mm	 kg
3607 RPR 100	100	35	140	134x114	105x80	13.5x11	200
3607 RPR 125	125	40	166	134x114	105x80	13.5x11	250
3607 RPR 150	150	45	189	134x114	105x80	13.5x11	350
3607 RPR 200	200	50	239	134x114	105x80	13.5x11	500



C2UR GÜÇLENDİRİLMİŞ POLİAMİD KASNAK ÜZERİ POLİÜRETAN KAPLAMA RULMANLI

KOD NO	 mm	 mm	 mm	 mm	 mm	 mm	 kg
3607 C2UR 150	150	45	189	134x114	105x80	13.5x11	400

- A:** OYNAK RULET MAŞASI
B: ÜST BİLYA KAPAĞI
C: KÜRESEL METAL TANE BİLYALAR
D: BORU PERÇİNİ
E: ALT BİLYA ÇANAĞI

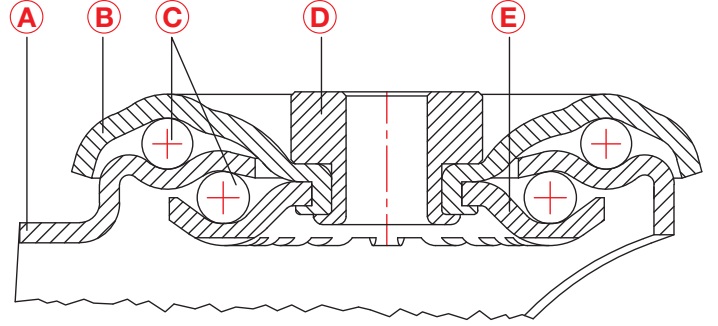

CTB		GÜÇLENDİRİLMİŞ POLİAMİD KASNAK ÜZERİ TERMOELASTİK KAPLAMA BURÇLU					
KOD NO	mm	mm	mm	mm	mm	kg	
3800 CTB 100	100	35	131	41	12	120	
3800 CTB 125	125	40	159	41	12	150	
3800 CTB 150	150	45	181	44	12	180	









CTB		GÜÇLENDİRİLMİŞ POLİAMİD KASNAK ÜZERİ TERMOELASTİK KAPLAMA BURÇLU					
KOD NO	mm	mm	mm	mm	mm	mm	kg
3800 CTB 100 F18	100	35	131	41	118	12	120
3800 CTB 125 F18	125	40	159	41	118	12	150
3800 CTB 150 F18	150	45	181	33.5	119	12	180



CTR		GÜÇLENDİRİLMİŞ POLİAMİD KASNAK ÜZERİ TERMOELASTİK KAPLAMA RULMANLI					
KOD NO	mm	mm	mm	mm	mm	kg	
3800 CTR 100	100	35	131	41	12	120	
3800 CTR 125	125	40	159	41	12	150	
3800 CTR 150	150	45	181	44	12	180	



CTR		GÜÇLENDİRİLMİŞ POLİAMİD KASNAK ÜZERİ TERMOELASTİK KAPLAMA RULMANLI					
KOD NO	 mm	 mm	 mm	 mm	 mm	 mm	 kg
3800 CTR 100 F18	100	35	131	41	118	12	120
3800 CTR 125 F18	125	40	159	41	118	12	150
3800 CTR 150 F18	150	45	181	33.5	119	12	180









MLB		MOBLEN KASNAK ÜZERİ SİYAH DOLGU LASTİK KAPLAMA BURÇLU					
KOD NO	 mm	 mm	 mm	 mm	 mm	 mm	 kg
3800 MLB 100	100	35	131	41		12	100
3800 MLB 125	125	40	159	41		12	130
3800 MLB 150	150	45	181	44		12	150









MLB		MOBLEN KASNAK ÜZERİ SİYAH DOLGU LASTİK KAPLAMA BURÇLU					
KOD NO	 mm	 mm	 mm	 mm	 mm	 mm	 kg
3800 MLB 100 F18	100	35	131	41	118	12	100
3800 MLB 125 F18	125	40	159	41	118	12	130
3800 MLB 150 F18	150	45	181	33.5	119	12	150









MMB		MOBLEN TEKER BURÇLU					
KOD NO	 mm	 mm	 mm	 mm	 mm	 mm	 kg
3800 MMB 100	100	35	131	41		12	150
3800 MMB 125	125	40	159	41		12	170
3800 MMB 150	150	45	181	44		12	190
3800 MMB 170	170	45	198	47		12	230









MMB		MOBLEN TEKER BURÇLU					
KOD NO	 mm	 mm	 mm	 mm	 mm	 mm	 kg
3800 MMB 100 F18	100	35	131	41	118	12	150
3800 MMB 125 F18	125	40	159	41	118	12	170
3800 MMB 150 F18	150	45	181	33.5	119	12	190









MMB		MOBLEN TEKER BURÇLU					
KOD NO	 mm	 mm	 mm	 mm	 mm	 mm	 kg
3800 MMB 170 F09	170	45	198	47	146	12	230









PPB		POLİAMİD TEKER BURÇLU					
KOD NO	 mm	 mm	 mm	 mm	 mm	 mm	 kg
3800 PPB 100	100	35	131	41	12	12	170
3800 PPB 125	125	40	159	41	12	12	200
3800 PPB 150	150	45	181	44	12	12	230
3800 PPB 170	170	45	198	47	12	12	250









PPB		POLİAMİD TEKER BURÇLU					
KOD NO	 mm	 mm	 mm	 mm	 mm	 mm	 kg
3800 PPB 100 F18	100	35	131	41	118	12	170
3800 PPB 125 F18	125	40	159	41	118	12	200
3800 PPB 150 F18	150	45	181	33.5	119	12	230









PPB		POLİAMİD TEKER BURÇLU					
KOD NO	 mm	 mm	 mm	 mm	 mm	 mm	 kg
3800 PPB 170 F09	170	45	198	47	146	12	250



PUB		POLİAMİD KASNAK ÜZERİ POLİÜRETAN KAPLAMA BURÇLU					
KOD NO	 mm	 mm	 mm	 mm	 mm	 mm	 kg
3800 PUB 100	100	35	131	41	12	12	180
3800 PUB 125	125	40	159	41	12	12	250
3800 PUB 150	150	45	181	44	12	12	400









PUB		POLİAMİD KASNAK ÜZERİ POLİÜRETAN KAPLAMA BURÇLU					
KOD NO	 mm	 mm	 mm	 mm	 mm	 mm	 kg
3800 PUB 100 F18	100	35	131	41	118	12	180
3800 PUB 125 F18	125	40	159	41	118	12	250
3800 PUB 150 F18	150	45	181	33.5	119	12	400



PUR		POLİAMİD KASNAK ÜZERİ POLİÜRETAN KAPLAMA RULMANLI					
KOD NO	 mm	 mm	 mm	 mm	 mm	 mm	 kg
3800 PUR 100	100	35	131	41	118	12	180
3800 PUR 125	125	40	159	41	118	12	250
3800 PUR 150	150	45	181	44	119	12	400



PUR		POLİAMİD KASNAK ÜZERİ POLİÜRETAN KAPLAMA RULMANLI					
KOD NO	 mm	 mm	 mm	 mm	 mm	 mm	 kg
3800 PUR 100 F18	100	35	131	41	118	12	180
3800 PUR 125 F18	125	40	159	41	118	12	250
3800 PUR 150 F18	150	45	181	33.5	119	12	400



PYB		POLİAMİD KASNAK ÜZERİ AĞIR TİP VULKANİZE SİYAH LASTİK KAPLAMA BURÇLU					
KOD NO	 mm	 mm	 mm	 mm	 mm	 mm	 kg
3800 PYB 100	100	35	131	41	118	12	120
3800 PYB 125	125	40	159	41	118	12	150
3800 PYB 150	150	45	181	44	119	12	180







PYB		POLİAMİD KASNAK ÜZERİ AĞIR TİP VULKANİZE SİYAH LASTİK KAPLAMA BURÇLU					
KOD NO	 mm	 mm	 mm	 mm	 mm	 mm	 kg
3800 PYB 100 F18	100	35	131	41	118	12	120
3800 PYB 125 F18	125	40	159	41	118	12	150
3800 PYB 150 F18	150	45	181	33.5	119	12	180









PYR		POLİAMİD KASNAK ÜZERİ AĞIR TİP VULKANİZE SİYAH LASTİK KAPLAMA RULMANLI					
KOD NO	 mm	 mm	 mm	 mm	 mm	 kg	
3800 PYR 100	100	35	131	41	12	120	
3800 PYR 125	125	40	159	41	12	150	
3800 PYR 150	150	45	181	44	12	180	









PYR		POLİAMİD KASNAK ÜZERİ AĞIR TİP VULKANİZE SİYAH LASTİK KAPLAMA RULMANLI					
KOD NO	 mm	 mm	 mm	 mm	 mm	 mm	 kg
3800 PYR 100 F18	100	35	131	41	118	12	120
3800 PYR 125 F18	125	40	159	41	118	12	150
3800 PYR 150 F18	150	45	181	33.5	119	12	180









RMB		AĞIR TİP MOBLEN TEKER BURÇLU					
KOD NO	 mm	 mm	 mm	 mm	 mm	 kg	
3800 RMB 100	100	35	131	41	12	160	
3800 RMB 125	125	40	159	41	12	200	
3800 RMB 150	150	45	181	44	12	220	
3800 RMB 170	170	45	198	47	12	240	









RMB		AĞIR TİP MOBLEN TEKER BURÇLU					
KOD NO	 mm	 mm	 mm	 mm	 mm	 mm	 kg
3800 RMB 100 F18	100	35	131	41	118	12	160
3800 RMB 125 F18	125	40	159	41	118	12	200
3800 RMB 150 F18	150	45	181	33.5	119	12	220









RMB		AĞIR TİP MOBLEN TEKER BURÇLU					
KOD NO	 mm	 mm	 mm	 mm	 mm	 mm	 kg
3800 RMB 170 F09	170	45	198	47	146	12	240









RPB		AĞIR TİP POLİAMİD TEKER BURÇLU					
KOD NO	 mm	 mm	 mm	 mm	 mm	 kg	
3800 RPB 100	100	35	131	41	12	250	
3800 RPB 125	125	40	159	41	12	300	
3800 RPB 150	150	45	181	44	12	350	
3800 RPB 170	170	45	198	47	12	370	









RPB		AĞIR TİP POLİAMİD TEKER BURÇLU					
KOD NO	 mm	 mm	 mm	 mm	 mm	 kg	
3800 RPB 100 F18	100	35	131	41	118	250	
3800 RPB 125 F18	125	40	159	41	118	300	
3800 RPB 150 F18	150	45	181	33.5	119	350	









RPB		AĞIR TİP POLİAMİD TEKER BURÇLU					
KOD NO	 mm	 mm	 mm	 mm	 mm	 kg	
3800 RPB 170 F09	170	45	198	47	146	370	







RPR		AĞIR TİP POLİAMİD TEKER RULMANLI					
KOD NO	 mm	 mm	 mm	 mm	 mm	 kg	
3800 RPR 100	100	35	131	41	12	250	
3800 RPR 125	125	40	159	41	12	300	
3800 RPR 150	150	45	181	44	12	350	









RPR		AĞIR TİP POLİAMİD TEKER RULMANLI					
KOD NO	 mm	 mm	 mm	 mm	 mm	 kg	
3800 RPR 100 F18	100	35	131	41	118	250	
3800 RPR 125 F18	125	40	159	41	118	300	
3800 RPR 150 F18	150	45	181	33.5	119	350	









SLP		GALVANİZ KAPLI SAC ÜZERİ SİYAH KAUÇUK LASTİK KAPLAMA POLİAMİD BURÇLU					
KOD NO							
	mm	mm	mm	mm	mm	kg	
3800 SLP 100	100	35	131	41	12	100	
3800 SLP 125	125	40	159	41	12	130	
3800 SLP 150	150	45	181	44	12	160	
3800 SLP 170	170	45	198	47	12	170	



SLP		GALVANİZ KAPLI SAC ÜZERİ SİYAH KAUÇUK LASTİK KAPLAMA POLİAMİD BURÇLU					
KOD NO							
	mm	mm	mm	mm	mm	mm	kg
3800 SLP 100 F18	100	35	131	41	118	12	100
3800 SLP 125 F18	125	40	159	41	118	12	130
3800 SLP 150 F18	150	45	181	33.5	119	12	160







SLP		GALVANİZ KAPLI SAC ÜZERİ SİYAH KAUÇUK LASTİK KAPLAMA POLİAMİD BURÇLU					
KOD NO							
	mm	mm	mm	mm	mm	mm	kg
3800 SLP 170 F09	170	45	198	47	146	12	170









SLS		GALVANİZ KAPLI SAC ÜZERİ SİYAH KAUÇUK LASTİK KAPLAMA MASURALI					
KOD NO							
	mm	mm	mm	mm	mm	kg	
3800 SLS 100	100	35	131	41	12	100	
3800 SLS 125	125	40	159	41	12	130	
3800 SLS 150	150	45	181	44	12	160	
3800 SLS 170	170	45	198	47	12	170	



SLS		GALVANİZ KAPLI SAC ÜZERİ SİYAH KAUÇUK LASTİK KAPLAMA MASURALI					
KOD NO							
	mm	mm	mm	mm	mm	mm	kg
3800 SLS 100 F18	100	35	131	41	118	12	100
3800 SLS 125 F18	125	40	159	41	118	12	130
3800 SLS 150 F18	150	45	181	33.5	119	12	160



SLS		GALVANİZ KAPLI SAC ÜZERİ SİYAH KAÇUK LASTİK KAPLAMA MASURALI					
KOD NO	 mm	 mm	 mm	 mm	 mm	 mm	 kg
3800 SLS 170 F09	170	45	198	47	146	12	170



C2UR		GÜÇLENDİRİLMİŞ POLİAMİD KASNAK ÜZERİ POLİÜRETAN KAPLAMA RULMANLI					
KOD NO	 mm	 mm	 mm	 mm	 mm	 mm	 kg
3800 C2UR 150	150	45	181	44	12		400



C2UR		GÜÇLENDİRİLMİŞ POLİAMİD KASNAK ÜZERİ POLİÜRETAN KAPLAMA RULMANLI					
KOD NO	 mm	 mm	 mm	 mm	 mm	 mm	 kg
3800 C2UR 150 F18	150	45	181	33.5	119	12	400

- A:** BAĞLANTI CİVATASI
- B:** ALTİGEN PUL
- C:** KISA BORU PERÇİNİ
- D:** ÜST BİLYA KAPAĞI
- E:** KÜRESEL METAL TANE BİLYALAR
- F:** OYNAK RULET MAŞASI
- G:** ALT BİLYA ÇANAĞI
- H:** MONTAJ PULU

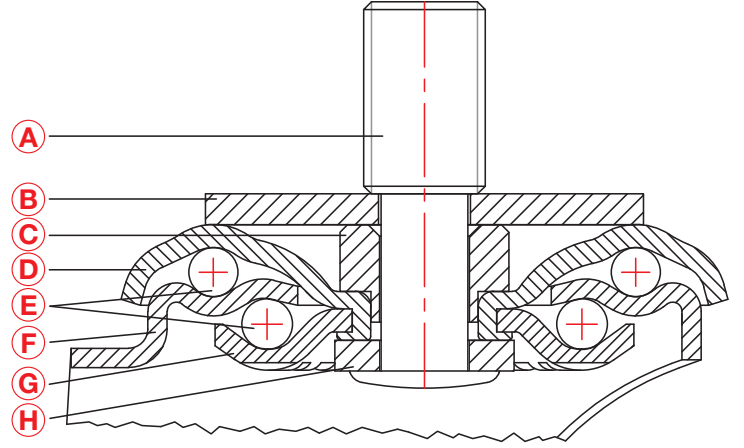

CTB		GÜÇLENDİRİLMİŞ POLİAMİD KASNAK ÜZERİ TERMOELASTİK KAPLAMA BURÇLU					
KOD NO	mm	mm	mm	mm	mm	mm	kg
3801 CTB 100	100	35	135	43	M12,M16,5/8"	30	120
3801 CTB 125	125	40	163	41	M12,M16,5/8"	30	150
3801 CTB 150	150	45	185	44	M12,M16,5/8"	30	180











CTB		GÜÇLENDİRİLMİŞ POLİAMİD KASNAK ÜZERİ TERMOELASTİK KAPLAMA BURÇLU						
KOD NO	mm	mm	mm	mm	mm	mm	kg	
3801 CTB 100 F18	100	35	135	43	118	M12,M16,5/8"	30	120
3801 CTB 125 F18	125	40	163	41	118	M12,M16,5/8"	30	150
3801 CTB 150 F18	150	45	185	33.5	119	M12,M16,5/8"	30	180



CTR		GÜÇLENDİRİLMİŞ POLİAMİD KASNAK ÜZERİ TERMOELASTİK KAPLAMA RULMANLI					
KOD NO	mm	mm	mm	mm	mm	mm	kg
3801 CTR 100	100	35	135	43	M12,M16,5/8"	30	120
3801 CTR 125	125	40	163	41	M12,M16,5/8"	30	150
3801 CTR 150	150	45	185	44	M12,M16,5/8"	30	180



CTR		GÜÇLENDİRİLMİŞ POLIAMİD KASNAK ÜZERİ TERMOELASTİK KAPLAMA RULMANLI							
KOD NO									
	mm	mm	mm	mm	mm	mm	mm	kg	
3801 CTR 100 F18	100	35	135	43	118	M12,M16,5/8"	30	120	
3801 CTR 125 F18	125	40	163	41	118	M12,M16,5/8"	30	150	
3801 CTR 150 F18	150	45	185	33.5	119	M12,M16,5/8"	30	180	











MLB		MOBLEN KASNAK ÜZERİ SİYAH DOLGU LASTİK KAPLAMA BURÇLU							
KOD NO									
	mm	mm	mm	mm	mm	mm	mm	kg	
3801 MLB 100	100	35	135	43	M12,M16,5/8"	30	100		
3801 MLB 125	125	40	163	41	M12,M16,5/8"	30	130		
3801 MLB 150	150	45	185	44	M12,M16,5/8"	30	150		











MLB		MOBLEN KASNAK ÜZERİ SİYAH DOLGU LASTİK KAPLAMA BURÇLU							
KOD NO									
	mm	mm	mm	mm	mm	mm	mm	kg	
3801 MLB 100 F18	100	35	135	43	118	M12,M16,5/8"	30	100	
3801 MLB 125 F18	125	40	163	41	118	M12,M16,5/8"	30	130	
3801 MLB 150 F18	150	45	185	33.5	119	M12,M16,5/8"	30	150	



MMB		MOBLEN TEKER BURÇLU							
KOD NO									
	mm	mm	mm	mm	mm	mm	mm	kg	
3801 MMB 100	100	35	135	43	M12,M16,5/8"	30	150		
3801 MMB 125	125	40	163	41	M12,M16,5/8"	30	170		
3801 MMB 150	150	45	185	44	M12,M16,5/8"	30	190		
3801 MMB 170	170	45	202	47	M12,M16,5/8"	30	230		



MMB		MOBLEN TEKER BURÇLU							
KOD NO									
	mm	mm	mm	mm	mm	mm	mm	kg	
3801 MMB 100 F18	100	35	135	43	118	M12,M16,5/8"	30	150	
3801 MMB 125 F18	125	40	163	41	118	M12,M16,5/8"	30	170	
3801 MMB 150 F18	150	45	185	33.5	119	M12,M16,5/8"	30	190	



MMB		MOBLEN TEKER BURÇLU						
KOD NO								
	mm	mm	mm	mm	mm	mm	mm	kg
3801 MMB 170 F09	170	45	202	47	146	M12,M16,5/8"	30	230



PPB		POLİAMİD TEKER BURÇLU						
KOD NO								
	mm	mm	mm	mm	mm	mm	mm	kg
3801 PPB 100	100	35	135	43	M12,M16,5/8"	30	170	
3801 PPB 125	125	40	163	41	M12,M16,5/8"	30	200	
3801 PPB 150	150	45	185	44	M12,M16,5/8"	30	230	
3801 PPB 170	170	45	202	47	M12,M16,5/8"	30	250	



PPB		POLİAMİD TEKER BURÇLU						
KOD NO								
	mm	mm	mm	mm	mm	mm	mm	kg
3801 PPB 100 F18	100	35	135	43	118	M12,M16,5/8"	30	170
3801 PPB 125 F18	125	40	163	41	118	M12,M16,5/8"	30	200
3801 PPB 150 F18	150	45	185	33.5	119	M12,M16,5/8"	30	230











PPB		POLİAMİD TEKER BURÇLU						
KOD NO								
	mm	mm	mm	mm	mm	mm	mm	kg
3801 PPB 170 F09	170	45	202	47	146	M12,M16,5/8"	30	250











PUB		POLİAMİD KASNAK ÜZERİ POLİÜRETAN KAPLAMA BURÇLU						
KOD NO								
	mm	mm	mm	mm	mm	mm	mm	kg
3801 PUB 100	100	35	135	43	M12,M16,5/8"	30	180	
3801 PUB 125	125	40	163	41	M12,M16,5/8"	30	250	
3801 PUB 150	150	45	185	44	M12,M16,5/8"	30	400	











PUB		POLİAMİD KASNAK ÜZERİ POLİÜRETAN KAPLAMA BURÇLU							
KOD NO									
	mm	mm	mm	mm	mm	mm	mm	kg	
3801 PUB 100 F18	100	35	135	43	118	M12,M16,5/8"	30	180	
3801 PUB 125 F18	125	40	163	41	118	M12,M16,5/8"	30	250	
3801 PUB 150 F18	150	45	185	33.5	119	M12,M16,5/8"	30	400	











PUR		POLİAMİD KASNAK ÜZERİ POLİÜRETAN KAPLAMA RULMANLI							
KOD NO									
	mm	mm	mm	mm	mm	mm	mm	kg	
3801 PUR 100	100	35	135	43	M12,M16,5/8"	30	180		
3801 PUR 125	125	40	163	41	M12,M16,5/8"	30	250		
3801 PUR 150	150	45	185	44	M12,M16,5/8"	30	400		











PUR		POLİAMİD KASNAK ÜZERİ POLİÜRETAN KAPLAMA RULMANLI							
KOD NO									
	mm	mm	mm	mm	mm	mm	mm	kg	
3801 PUR 100 F18	100	35	135	43	118	M12,M16,5/8"	30	180	
3801 PUR 125 F18	125	40	163	41	118	M12,M16,5/8"	30	250	
3801 PUR 150 F18	150	45	185	33.5	119	M12,M16,5/8"	30	400	









PYB		POLİAMİD KASNAK ÜZERİ AĞIR TİP VULKANİZE SİYAH LASTİK KAPLAMA BURÇLU							
KOD NO									
	mm	mm	mm	mm	mm	mm	mm	kg	
3801 PYB 100	100	35	135	43	M12,M16,5/8"	30	120		
3801 PYB 125	125	40	163	41	M12,M16,5/8"	30	150		
3801 PYB 150	150	45	185	44	M12,M16,5/8"	30	180		









PYB		POLİAMİD KASNAK ÜZERİ AĞIR TİP VULKANİZE SİYAH LASTİK KAPLAMA BURÇLU							
KOD NO									
	mm	mm	mm	mm	mm	mm	mm	kg	
3801 PYB 100 F18	100	35	135	43	118	M12,M16,5/8"	30	120	
3801 PYB 125 F18	125	40	163	41	118	M12,M16,5/8"	30	150	
3801 PYB 150 F18	150	45	185	33.5	119	M12,M16,5/8"	30	180	









PYR		POLİAMİD KASNAK ÜZERİ AĞIR TİP VULKANİZE SİYAH LASTİK KAPLAMA RULMANLI						
KOD NO	 mm	 mm	 mm	 mm	 mm	 mm	 kg	
3801 PYR 100	100	35	135	43	M12,M16,5/8"	30	120	
3801 PYR 125	125	40	163	41	M12,M16,5/8"	30	150	
3801 PYR 150	150	45	185	44	M12,M16,5/8"	30	180	









PYR		POLİAMİD KASNAK ÜZERİ AĞIR TİP VULKANİZE SİYAH LASTİK KAPLAMA RULMANLI						
KOD NO	 mm	 mm	 mm	 mm	 mm	 mm	 kg	
3801 PYR 100 F18	100	35	135	43	118	M12,M16,5/8"	30	120
3801 PYR 125 F18	125	40	163	41	118	M12,M16,5/8"	30	150
3801 PYR 150 F18	150	45	185	33.5	119	M12,M16,5/8"	30	180









RMB		AĞIR TİP MOBLEN TEKER BURÇLU						
KOD NO	 mm	 mm	 mm	 mm	 mm	 mm	 kg	
3801 RMB 100	100	35	135	43	M12,M16,5/8"	30	160	
3801 RMB 125	125	40	163	41	M12,M16,5/8"	30	200	
3801 RMB 150	150	45	185	44	M12,M16,5/8"	30	220	
3801 RMB 170	170	45	202	47	M12,M16,5/8"	30	240	



RMB		AĞIR TİP MOBLEN TEKER BURÇLU						
KOD NO	 mm	 mm	 mm	 mm	 mm	 mm	 kg	
3801 RMB 100 F18	100	35	135	43	118	M12,M16,5/8"	30	160
3801 RMB 125 F18	125	40	163	41	118	M12,M16,5/8"	30	200
3801 RMB 150 F18	150	45	185	33.5	119	M12,M16,5/8"	30	220



RMB		AĞIR TİP MOBLEN TEKER BURÇLU						
KOD NO	 mm	 mm	 mm	 mm	 mm	 mm	 kg	
3801 RMB 170 F09	170	45	202	47	146	M12,M16,5/8"	30	240



RPB		AĞIR TİP POLİAMİD TEKER BURÇLU						
KOD NO	mm	mm	mm	mm	mm	mm	mm	kg
3801 RPB 100	100	35	135	43	M12,M16,5/8"	30	250	
3801 RPB 125	125	40	163	41	M12,M16,5/8"	30	300	
3801 RPB 150	150	45	185	44	M12,M16,5/8"	30	350	
3801 RPB 170	170	45	202	47	M12,M16,5/8"	30	370	



RPB		AĞIR TİP POLİAMİD TEKER BURÇLU						
KOD NO	mm	mm	mm	mm	mm	mm	mm	kg
3801 RPB 100 F18	100	35	135	43	118	M12,M16,5/8"	30	250
3801 RPB 125 F18	125	40	163	41	118	M12,M16,5/8"	30	300
3801 RPB 150 F18	150	45	185	33.5	119	M12,M16,5/8"	30	350

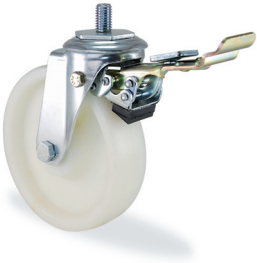

RPB		AĞIR TİP POLİAMİD TEKER BURÇLU						
KOD NO	mm	mm	mm	mm	mm	mm	mm	kg
3801 RPB 170 F09	170	45	202	47	146	M12,M16,5/8"	30	370



RPR		AĞIR TİP POLİAMİD TEKER RULMANLI						
KOD NO	mm	mm	mm	mm	mm	mm	mm	kg
3801 RPR 100	100	35	135	43	M12,M16,5/8"	30	250	
3801 RPR 125	125	40	163	41	M12,M16,5/8"	30	300	
3801 RPR 150	150	45	185	44	M12,M16,5/8"	30	350	



RPR		AĞIR TİP POLİAMİD TEKER RULMANLI						
KOD NO	mm	mm	mm	mm	mm	mm	mm	kg
3801 RPR 100 F18	100	35	135	43	118	M12,M16,5/8"	30	250
3801 RPR 125 F18	125	40	163	41	118	M12,M16,5/8"	30	300
3801 RPR 150 F18	150	45	185	33.5	119	M12,M16,5/8"	30	350



SLP		GALVANİZ KAPLI SAC ÜZERİ SİYAH KAÜÇUK LASTİK KAPLAMA POLİAMİD BURÇLU						
KOD NO	mm	mm	mm	mm	mm	mm	mm	kg
3801 SLP 100	100	35	135	43	M12,M16,5/8"		30	100
3801 SLP 125	125	40	163	41	M12,M16,5/8"		30	130
3801 SLP 150	150	45	185	44	M12,M16,5/8"		30	160
3801 SLP 170	170	45	202	47	M12,M16,5/8"		30	170



SLP		GALVANİZ KAPLI SAC ÜZERİ SİYAH KAÜÇUK LASTİK KAPLAMA POLİAMİD BURÇLU						
KOD NO	mm	mm	mm	mm	mm	mm	mm	kg
3801 SLP 100 F18	100	35	135	43	118	M12,M16,5/8"	30	100
3801 SLP 125 F18	125	40	163	41	118	M12,M16,5/8"	30	130
3801 SLP 150 F18	150	45	185	33.5	119	M12,M16,5/8"	30	160



SLP		GALVANİZ KAPLI SAC ÜZERİ SİYAH KAÜÇUK LASTİK KAPLAMA POLİAMİD BURÇLU						
KOD NO	mm	mm	mm	mm	mm	mm	mm	kg
3801 SLP 170 F09	170	45	202	47	146	M12,M16,5/8"	30	170







SLS		GALVANİZ KAPLI SAC ÜZERİ SİYAH KAÜÇUK LASTİK KAPLAMA MASURALI						
KOD NO	mm	mm	mm	mm	mm	mm	mm	kg
3801 SLS 100	100	35	135	43	M12,M16,5/8"		30	100
3801 SLS 125	125	40	163	41	M12,M16,5/8"		30	130
3801 SLS 150	150	45	185	44	M12,M16,5/8"		30	160
3801 SLS 170	170	45	202	47	M12,M16,5/8"		30	170











SLS		GALVANİZ KAPLI SAC ÜZERİ SİYAH KAÜÇUK LASTİK KAPLAMA MASURALI						
KOD NO	mm	mm	mm	mm	mm	mm	mm	kg
3801 SLS 100 F18	100	35	135	43	118	M12,M16,5/8"	30	100
3801 SLS 125 F18	125	40	163	41	118	M12,M16,5/8"	30	130
3801 SLS 150 F18	150	45	185	33.5	119	M12,M16,5/8"	30	160







SLS		GALVANİZ KAPLI SAC ÜZERİ SİYAH KAÇUK LASTİK KAPLAMA MASURALI						
KOD NO	 mm	 mm	 mm	 mm	 mm	 mm	 mm	 kg
3801 SLS 170 F09	170	45	202	47	146	M12,M16,5/8"	30	170



C2UR		GÜÇLENDİRİLMİŞ POLİAMİD KASNAK ÜZERİ OVAL POLİÜRETAN KAPLAMA RULMANLI						
KOD NO	 mm	 mm	 mm	 mm	 mm	 mm	 mm	 kg
3801 C2UR 150	150	45	185	44	M12,M16,5/8"	30	400	



C2UR		GÜÇLENDİRİLMİŞ POLİAMİD KASNAK ÜZERİ OVAL POLİÜRETAN KAPLAMA RULMANLI						
KOD NO	 mm	 mm	 mm	 mm	 mm	 mm	 mm	 kg
3801 C2UR 150 F18	150	45	185	33.5	119	M12,M16,5/8"	30	400

- A:** OYNAK BAĞLANTI TABLASI
- B:** OYNAK RULET MAŞASI
- C:** BİLYA MUHAFAZA TOZLUK
- D:** KÜRESEL METAL TANE BİLYALAR
- E:** ALT BİLYA ÇANAĞI
- F:** TABLA PERÇİNİ
- G:** MONTAJ PULU

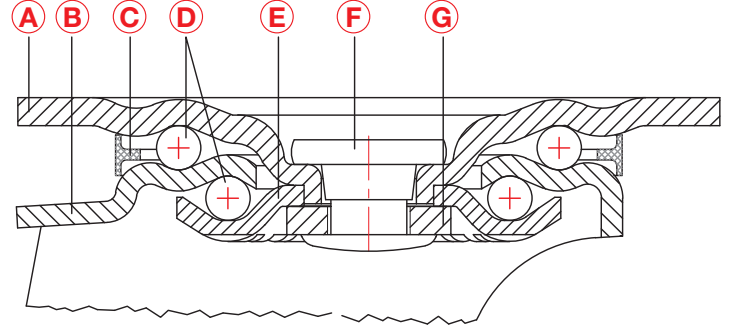

CTB		GÜÇLENDİRİLMİŞ POLIAMİD KASNAK ÜZERİ TERMOELASTİK KAPLAMA BURÇLU						
KOD NO								kg
	mm	mm	mm	mm	mm	mm	mm	
3802 CTB 100	100	35	133	43	100x85	80x60	12.5x9.3	120
3802 CTB 125	125	40	161	41	100x85	80x60	12.5x9.3	150
3802 CTB 150	150	45	183	44	100x85	80x60	12.5x9.3	180



CTB		GÜÇLENDİRİLMİŞ POLIAMİD KASNAK ÜZERİ TERMOELASTİK KAPLAMA BURÇLU							
KOD NO								kg	
	mm	mm	mm	mm	mm	mm	mm		
3802 CTB 100 F18	100	35	133	43	118	100x85	80x60	12.5x9.3	120
3802 CTB 125 F18	125	40	161	41	118	100x85	80x60	12.5x9.3	150
3802 CTB 150 F18	150	45	183	33.5	119	100x85	80x60	12.5x9.3	180

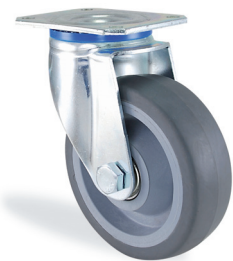

CTR		GÜÇLENDİRİLMİŞ POLIAMİD KASNAK ÜZERİ TERMOELASTİK KAPLAMA RULMANLI						
KOD NO								kg
	mm	mm	mm	mm	mm	mm	mm	
3802 CTR 100	100	35	133	43	100x85	80x60	12.5x9.3	120
3802 CTR 125	125	40	161	41	100x85	80x60	12.5x9.3	150
3802 CTR 150	150	45	183	44	100x85	80x60	12.5x9.3	180



CTR		GÜÇLENDİRİLMİŞ POLİAMİD KASNAK ÜZERİ TERMOELASTİK KAPLAMA RULMANLI							
KOD NO									
	mm	mm	mm	mm	mm	mm	mm	mm	kg
3802 CTR 100 F18	100	35	133	43	118	100x85	80x60	12.5x9.3	120
3802 CTR 125 F18	125	40	161	41	118	100x85	80x60	12.5x9.3	150
3802 CTR 150 F18	150	45	183	33.5	119	100x85	80x60	12.5x9.3	180



MLB		MOBLEN KASNAK ÜZERİ SİYAH DOLGU LASTİK KAPLAMA BURÇLU							
KOD NO									
	mm	mm	mm	mm	mm	mm	mm	mm	kg
3802 MLB 100	100	35	133	43	118	100x85	80x60	12.5x9.3	100
3802 MLB 125	125	40	161	41	118	100x85	80x60	12.5x9.3	130
3802 MLB 150	150	45	183	44	119	100x85	80x60	12.5x9.3	150



MLB		MOBLEN KASNAK ÜZERİ SİYAH DOLGU LASTİK KAPLAMA BURÇLU							
KOD NO									
	mm	mm	mm	mm	mm	mm	mm	mm	kg
3802 MLB 100 F18	100	35	133	43	118	100x85	80x60	12.5x9.3	100
3802 MLB 125 F18	125	40	161	41	118	100x85	80x60	12.5x9.3	130
3802 MLB 150 F18	150	45	183	33.5	119	100x85	80x60	12.5x9.3	150



MMB		MOBLEN TEKER BURÇLU							
KOD NO									
	mm	mm	mm	mm	mm	mm	mm	mm	kg
3802 MMB 100	100	35	133	43	118	100x85	80x60	12.5x9.3	150
3802 MMB 125	125	40	161	41	118	100x85	80x60	12.5x9.3	170
3802 MMB 150	150	45	183	44	119	100x85	80x60	12.5x9.3	190
3802 MMB 170	170	45	200	47	119	100x85	80x60	12.5x9.3	230



MMB		MOBLEN TEKER BURÇLU							
KOD NO									
	mm	mm	mm	mm	mm	mm	mm	mm	kg
3802 MMB 100 F18	100	35	133	43	118	100x85	80x60	12.5x9.3	150
3802 MMB 125 F18	125	40	161	41	118	100x85	80x60	12.5x9.3	170
3802 MMB 150 F18	150	45	183	33.5	119	100x85	80x60	12.5x9.3	190



MMB		MOBLEN TEKER BURÇLU							
KOD NO									
	mm	mm	mm	mm	mm	mm	mm	mm	kg
3802 MMB 170 F09	170	45	200	47	146	100x85	80x60	12.5x9.3	230



PPB		POLİAMİD TEKER BURÇLU							
KOD NO									
	mm	mm	mm	mm	mm	mm	mm	mm	kg
3802 PPB 100	100	35	133	43		100x85	80x60	12.5x9.3	170
3802 PPB 125	125	40	161	41		100x85	80x60	12.5x9.3	200
3802 PPB 150	150	45	183	44		100x85	80x60	12.5x9.3	230
3802 PPB 170	170	45	200	47		100x85	80x60	12.5x9.3	250



PPB		POLİAMİD TEKER BURÇLU							
KOD NO									
	mm	mm	mm	mm	mm	mm	mm	mm	kg
3802 PPB 100 F18	100	35	133	43	118	100x85	80x60	12.5x9.3	170
3802 PPB 125 F18	125	40	161	41	118	100x85	80x60	12.5x9.3	200
3802 PPB 150 F18	150	45	183	33.5	119	100x85	80x60	12.5x9.3	230



PPB		POLİAMİD TEKER BURÇLU							
KOD NO									
	mm	mm	mm	mm	mm	mm	mm	mm	kg
3802 PPB 170 F09	170	45	200	47	146	100x85	80x60	12.5x9.3	250



PUB		POLİAMİD KASNAK ÜZERİ POLİÜRETAN KAPLAMA BURÇLU							
KOD NO									
	mm	mm	mm	mm	mm	mm	mm	mm	kg
3802 PUB 100	100	35	133	43		100x85	80x60	12.5x9.3	180
3802 PUB 125	125	40	161	41		100x85	80x60	12.5x9.3	250
3802 PUB 150	150	45	183	44		100x85	80x60	12.5x9.3	400



PYR		POLİAMİD KASNAK ÜZERİ AĞIR TİP VULKANİZE SİYAH LASTİK KAPLAMA RULMANLI						
KOD NO								
	mm	mm	mm	mm	mm	mm	mm	kg
3802 PYR 100	100	35	133	43	100x85	80x60	12.5x9.3	120
3802 PYR 125	125	40	161	41	100x85	80x60	12.5x9.3	150
3802 PYR 150	150	45	183	44	100x85	80x60	12.5x9.3	180



PYR		POLİAMİD KASNAK ÜZERİ AĞIR TİP VULKANİZE SİYAH LASTİK KAPLAMA RULMANLI							
KOD NO									
	mm	mm	mm	mm	mm	mm	mm	mm	kg
3802 PYR 100 F18	100	35	133	43	118	100x85	80x60	12.5x9.3	120
3802 PYR 125 F18	125	40	161	41	118	100x85	80x60	12.5x9.3	150
3802 PYR 150 F18	150	45	183	33.5	119	100x85	80x60	12.5x9.3	180



RMB		AĞIR TİP MOBLEN TEKER BURÇLU							
KOD NO									
	mm	mm	mm	mm	mm	mm	mm	mm	kg
3802 RMB 100	100	35	133	43		100x85	80x60	12.5x9.3	160
3802 RMB 125	125	40	161	41		100x85	80x60	12.5x9.3	200
3802 RMB 150	150	45	183	44		100x85	80x60	12.5x9.3	220
3802 RMB 170	170	45	200	47		100x85	80x60	12.5x9.3	240



RMB		AĞIR TİP MOBLEN TEKER BURÇLU							
KOD NO									
	mm	mm	mm	mm	mm	mm	mm	mm	kg
3802 RMB 100 F18	100	35	133	43	118	100x85	80x60	12.5x9.3	160
3802 RMB 125 F18	125	40	161	41	118	100x85	80x60	12.5x9.3	200
3802 RMB 150 F18	150	45	183	33.5	119	100x85	80x60	12.5x9.3	220



RMB		AĞIR TİP MOBLEN TEKER BURÇLU							
KOD NO									
	mm	mm	mm	mm	mm	mm	mm	mm	kg
3802 RMB 170 F09	170	45	200	47	146	100x85	80x60	12.5x9.3	240



RPB		AĞIR TİP POLİAMİD TEKER BURÇLU						
KOD NO								
	mm	mm	mm	mm	mm	mm	mm	kg
3802 RPB 100	100	35	133	43	100x85	80x60	12.5x9.3	250
3802 RPB 125	125	40	161	41	100x85	80x60	12.5x9.3	300
3802 RPB 150	150	45	183	44	100x85	80x60	12.5x9.3	350
3802 RPB 170	170	45	200	47	100x85	80x60	12.5x9.3	370



RPB		AĞIR TİP POLİAMİD TEKER BURÇLU							
KOD NO									
	mm	mm	mm	mm	mm	mm	mm	mm	kg
3802 RPB 100 F18	100	35	133	43	118	100x85	80x60	12.5x9.3	250
3802 RPB 125 F18	125	40	161	41	118	100x85	80x60	12.5x9.3	300
3802 RPB 150 F18	150	45	183	33.5	119	100x85	80x60	12.5x9.3	350



RPB		AĞIR TİP POLİAMİD TEKER BURÇLU							
KOD NO									
	mm	mm	mm	mm	mm	mm	mm	mm	kg
3802 RPB 170 F09	170	45	200	47	146	100x85	80x60	12.5x9.3	370



RPR		AĞIR TİP POLİAMİD TEKER RULMANLI							
KOD NO									
	mm	mm	mm	mm	mm	mm	mm	mm	kg
3802 RPR 100	100	35	133	43	100x85	80x60	12.5x9.3	250	
3802 RPR 125	125	40	161	41	100x85	80x60	12.5x9.3	300	
3802 RPR 150	150	45	183	44	100x85	80x60	12.5x9.3	350	



RPR		AĞIR TİP POLİAMİD TEKER RULMANLI								
KOD NO										
	mm	mm	mm	mm	mm	mm	mm	mm	mm	kg
3802 RPR 100 F18	100	35	133	43	118	100x85	80x60	12.5x9.3	250	
3802 RPR 125 F18	125	40	161	41	118	100x85	80x60	12.5x9.3	300	
3802 RPR 150 F18	150	45	183	33.5	119	100x85	80x60	12.5x9.3	350	



SLP		GALVANİZ KAPLI SAC ÜZERİ SİYAH KAUÇUK LASTİK KAPLAMA POLİAMİD BURÇLU						
KOD NO								
	mm	mm	mm	mm	mm	mm	mm	kg
3802 SLP 100	100	35	133	43	100x85	80x60	12.5x9.3	100
3802 SLP 125	125	40	161	41	100x85	80x60	12.5x9.3	130
3802 SLP 150	150	45	183	44	100x85	80x60	12.5x9.3	160
3802 SLP 170	170	45	200	47	100x85	80x60	12.5x9.3	170



SLP		GALVANİZ KAPLI SAC ÜZERİ SİYAH KAUÇUK LASTİK KAPLAMA POLİAMİD BURÇLU							
KOD NO									
	mm	mm	mm	mm	mm	mm	mm	mm	kg
3802 SLP 100 F18	100	35	133	43	118	100x85	80x60	12.5x9.3	100
3802 SLP 125 F18	125	40	161	41	118	100x85	80x60	12.5x9.3	130
3802 SLP 150 F18	150	45	183	33.5	119	100x85	80x60	12.5x9.3	160



SLP		GALVANİZ KAPLI SAC ÜZERİ SİYAH KAUÇUK LASTİK KAPLAMA POLİAMİD BURÇLU							
KOD NO									
	mm	mm	mm	mm	mm	mm	mm	mm	kg
3802 SLP 170 F09	170	45	200	47	146	100x85	80x60	12.5x9.3	170











SLS		GALVANİZ KAPLI SAC ÜZERİ SİYAH KAUÇUK LASTİK KAPLAMA MASURALI						
KOD NO								
	mm	mm	mm	mm	mm	mm	mm	kg
3802 SLS 100	100	35	133	43	100x85	80x60	12.5x9.3	100
3802 SLS 125	125	40	161	41	100x85	80x60	12.5x9.3	130
3802 SLS 150	150	45	183	44	100x85	80x60	12.5x9.3	160
3802 SLS 170	170	45	200	47	100x85	80x60	12.5x9.3	170



SLS		GALVANİZ KAPLI SAC ÜZERİ SİYAH KAUÇUK LASTİK KAPLAMA MASURALI							
KOD NO									
	mm	mm	mm	mm	mm	mm	mm	mm	kg
3802 SLS 100 F18	100	35	133	43	118	100x85	80x60	12.5x9.3	100
3802 SLS 125 F18	125	40	161	41	118	100x85	80x60	12.5x9.3	130
3802 SLS 150 F18	150	45	183	33.5	119	100x85	80x60	12.5x9.3	160



SLS		GALVANİZ KAPLI SAC ÜZERİ SİYAH KAUÇUK LASTİK KAPLAMA MASURALI							
KOD NO									
	mm	mm	mm	mm	mm	mm	mm	mm	kg
3802 SLS 170 F09	170	45	200	47	146	100x85	80x60	12.5x9.3	170



C2UR		GÜÇLENDİRİLMİŞ POLİAMİD KASNAK ÜZERİ OVAL POLİÜRETAN KAPLAMA RULMANLI							
KOD NO									
	mm	mm	mm	mm	mm	mm	mm	mm	kg
3802 C2UR 150	150	45	183	44		100x85	80x60	12.5x9.3	400



C2UR		GÜÇLENDİRİLMİŞ POLİAMİD KASNAK ÜZERİ OVAL POLİÜRETAN KAPLAMA RULMANLI							
KOD NO									
	mm	mm	mm	mm	mm	mm	mm	mm	kg
3802 C2UR 150 F18	150	45	183	33.5	119	100x85	80x60	12.5x9.3	400

- A:** BAĞLANTI PİMİ
B: ÜST BİLYA KAPAĞI
C: KÜRESEL METAL TANE BİLYALAR
D: OYNAK RULET MAŞASI
E: ALT BİLYA ÇANAĞI
F: MONTAJ PULU

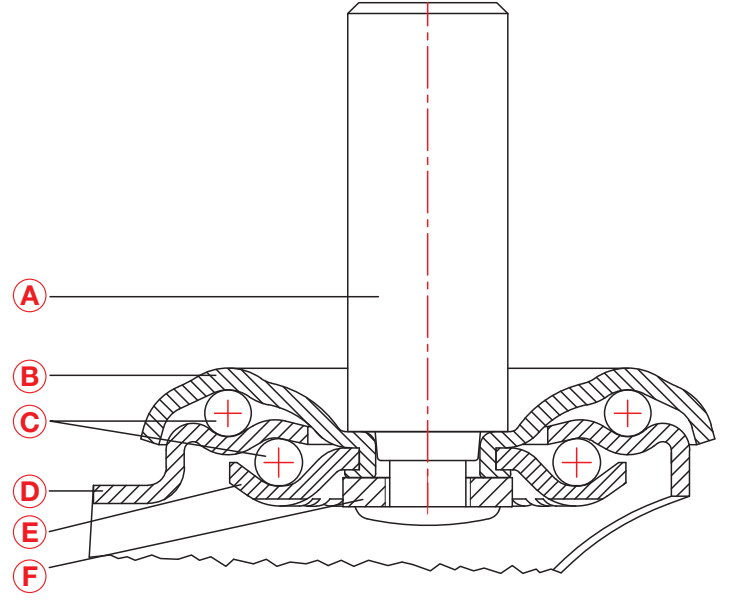

CTB		GÜÇLENDİRİLMİŞ POLİAMİD KASNAK ÜZERİ TERMOELASTİK KAPLAMA BURÇLU						
KOD NO	mm	mm	mm	mm	mm	mm	kg	
3805 CTB 100	100	35	131	43	22	50	120	
3805 CTB 125	125	40	159	41	22	50	150	
3805 CTB 150	150	45	181	44	22	50	180	











CTB		GÜÇLENDİRİLMİŞ POLİAMİD KASNAK ÜZERİ TERMOELASTİK KAPLAMA BURÇLU						
KOD NO	mm	mm	mm	mm	mm	mm	kg	
3805 CTB 100 F18	100	35	131	43	118	22	50	120
3805 CTB 125 F18	125	40	159	41	118	22	50	150
3805 CTB 150 F18	150	45	181	33.5	119	22	50	180











CTR		GÜÇLENDİRİLMİŞ POLİAMİD KASNAK ÜZERİ TERMOELASTİK KAPLAMA RULMANLI						
KOD NO	mm	mm	mm	mm	mm	mm	kg	
3805 CTR 100	100	35	131	43	22	50	120	
3805 CTR 125	125	40	159	41	22	50	150	
3805 CTR 150	150	45	181	44	22	50	180	









CTR
GÜÇLENDİRİLMİŞ POLIAMİD KASNAK ÜZERİ TERMOELASTİK KAPLAMA RULMANLI

KOD NO	 mm	 mm	 mm	 mm	 mm	 mm	 mm	 kg
3805 CTR 100 F18	100	35	131	43	118	22	50	120
3805 CTR 125 F18	125	40	159	41	118	22	50	150
3805 CTR 150 F18	150	45	181	33.5	119	22	50	180









MLB
MOBLEN KASNAK ÜZERİ SİYAH DOLGU LASTİK KAPLAMA BURÇLU

KOD NO	 mm	 mm	 mm	 mm	 mm	 mm	 mm	 kg
3805 MLB 100	100	35	131	43	22	50	100	
3805 MLB 125	125	40	159	41	22	50	130	
3805 MLB 150	150	45	181	44	22	50	150	









MLB
MOBLEN KASNAK ÜZERİ SİYAH DOLGU LASTİK KAPLAMA BURÇLU

KOD NO	 mm	 mm	 mm	 mm	 mm	 mm	 mm	 kg
3805 MLB 100 F18	100	35	131	43	118	22	50	100
3805 MLB 125 F18	125	40	159	41	118	22	50	130
3805 MLB 150 F18	150	45	181	33.5	119	22	50	150









MMB
MOBLEN TEKER BURÇLU

KOD NO	 mm	 mm	 mm	 mm	 mm	 mm	 mm	 kg
3805 MMB 100	100	35	131	43	22	50	150	
3805 MMB 125	125	40	159	41	22	50	170	
3805 MMB 150	150	45	181	44	22	50	190	
3805 MMB 170	170	45	198	47	22	50	230	









MMB
MOBLEN TEKER BURÇLU

KOD NO	 mm	 mm	 mm	 mm	 mm	 mm	 mm	 kg
3805 MMB 100 F18	100	35	131	43	118	22	50	150
3805 MMB 125 F18	125	40	159	41	118	22	50	170
3805 MMB 150 F18	150	45	181	33.5	119	22	50	190











MMB		MOBLEN TEKER BURÇLU						
KOD NO	 mm	 mm	 mm	 mm	 mm	 mm	 mm	 kg
3805 MMB 170 F09	170	45	198	47	146	22	50	230











PPB		POLİAMİD TEKER BURÇLU						
KOD NO	 mm	 mm	 mm	 mm	 mm	 mm	 mm	 kg
3805 PPB 100	100	35	131	43	22	50	170	
3805 PPB 125	125	40	159	41	22	50	200	
3805 PPB 150	150	45	181	44	22	50	230	
3805 PPB 170	170	45	198	47	22	50	250	











PPB		POLİAMİD TEKER BURÇLU						
KOD NO	 mm	 mm	 mm	 mm	 mm	 mm	 mm	 kg
3805 PPB 100 F18	100	35	131	43	118	22	50	170
3805 PPB 125 F18	125	40	159	41	118	22	50	200
3805 PPB 150 F18	150	45	181	33.5	119	22	50	230











PPB		POLİAMİD TEKER BURÇLU						
KOD NO	 mm	 mm	 mm	 mm	 mm	 mm	 mm	 kg
3805 PPB 170 F09	170	45	198	47	146	22	50	250











PUB		POLİAMİD KASNAK ÜZERİ POLİÜRETAN KAPLAMA BURÇLU						
KOD NO	 mm	 mm	 mm	 mm	 mm	 mm	 mm	 kg
3805 PUB 100	100	35	131	43	22	50	180	
3805 PUB 125	125	40	159	41	22	50	250	
3805 PUB 150	150	45	181	44	22	50	400	











PUB		POLİAMİD KASNAK ÜZERİ POLİÜRETAN KAPLAMA BURÇLU						
KOD NO								
	mm	mm	mm	mm	mm	mm	mm	kg
3805 PUB 100 F18	100	35	131	43	118	22	50	180
3805 PUB 125 F18	125	40	159	41	118	22	50	250
3805 PUB 150 F18	150	45	181	33.5	119	22	50	400











PUR		POLİAMİD KASNAK ÜZERİ POLİÜRETAN KAPLAMA RULMANLI						
KOD NO								
	mm	mm	mm	mm	mm	mm	mm	kg
3805 PUR 100	100	35	131	43	22	50	180	
3805 PUR 125	125	40	159	41	22	50	250	
3805 PUR 150	150	45	181	44	22	50	400	











PUR		POLİAMİD KASNAK ÜZERİ POLİÜRETAN KAPLAMA RULMANLI						
KOD NO								
	mm	mm	mm	mm	mm	mm	mm	kg
3805 PUR 100 F18	100	35	131	43	118	22	50	180
3805 PUR 125 F18	125	40	159	41	118	22	50	250
3805 PUR 150 F18	150	45	181	33.5	119	22	50	400









PYB		POLİAMİD KASNAK ÜZERİ AĞIR TİP VULKANİZE SİYAH LASTİK KAPLAMA BURÇLU						
KOD NO								
	mm	mm	mm	mm	mm	mm	mm	kg
3805 PYB 100	100	35	131	43	22	50	120	
3805 PYB 125	125	40	159	41	22	50	150	
3805 PYB 150	150	45	181	44	22	50	180	









PYB		POLİAMİD KASNAK ÜZERİ AĞIR TİP VULKANİZE SİYAH LASTİK KAPLAMA BURÇLU						
KOD NO								
	mm	mm	mm	mm	mm	mm	mm	kg
3805 PYB 100 F18	100	35	131	43	118	22	50	120
3805 PYB 125 F18	125	40	159	41	118	22	50	150
3805 PYB 150 F18	150	45	181	33.5	119	22	50	180









PYR		POLİAMİD KASNAK ÜZERİ AĞIR TİP VULKANİZE SİYAH LASTİK KAPLAMA RULMANLI					
KOD NO	 mm	 mm	 mm	 mm	 mm	 mm	 kg
3805 PYR 100	100	35	131	43	22	50	120
3805 PYR 125	125	40	159	41	22	50	150
3805 PYR 150	150	45	181	44	22	50	180









PYR		POLİAMİD KASNAK ÜZERİ AĞIR TİP VULKANİZE SİYAH LASTİK KAPLAMA RULMANLI						
KOD NO	 mm	 mm	 mm	 mm	 mm	 mm	 kg	
3805 PYR 100 F18	100	35	131	43	118	22	50	120
3805 PYR 125 F18	125	40	159	41	118	22	50	150
3805 PYR 150 F18	150	45	181	33.5	119	22	50	180









RMB		AĞIR TİP MOBLEN TEKER BURÇLU					
KOD NO	 mm	 mm	 mm	 mm	 mm	 mm	 kg
3805 RMB 100	100	35	131	43	22	50	160
3805 RMB 125	125	40	159	41	22	50	200
3805 RMB 150	150	45	181	44	22	50	220
3805 RMB 170	170	45	198	47	22	50	240









RMB		AĞIR TİP MOBLEN TEKER BURÇLU						
KOD NO	 mm	 mm	 mm	 mm	 mm	 mm	 kg	
3805 RMB 100 F18	100	35	131	43	118	22	50	160
3805 RMB 125 F18	125	40	159	41	118	22	50	200
3805 RMB 150 F18	150	45	181	33.5	119	22	50	220











RMB		AĞIR TİP MOBLEN TEKER BURÇLU						
KOD NO	 mm	 mm	 mm	 mm	 mm	 mm	 kg	
3805 RMB 170 F09	170	45	198	47	146	22	50	240











RPB		AĞIR TİP POLİAMİD TEKER BURÇLU						
KOD NO	 mm	 mm	 mm	 mm	 mm	 mm	 kg	
3805 RPB 100	100	35	131	43	22	50	250	
3805 RPB 125	125	40	159	41	22	50	300	
3805 RPB 150	150	45	181	44	22	50	350	
3805 RPB 170	170	45	198	47	22	50	370	











RPB		AĞIR TİP POLİAMİD TEKER BURÇLU							
KOD NO	 mm	 mm	 mm	 mm	 mm	 mm	 mm	 kg	
3805 RPB 100 F18	100	35	131	43	118	22	50	250	
3805 RPB 125 F18	125	40	159	41	118	22	50	300	
3805 RPB 150 F18	150	45	181	33.5	119	22	50	350	











RPB		AĞIR TİP POLİAMİD TEKER BURÇLU							
KOD NO	 mm	 mm	 mm	 mm	 mm	 mm	 mm	 kg	
3805 RPB 170 F09	170	45	198	47	146	22	50	370	









RPR		AĞIR TİP POLİAMİD TEKER RULMANLI						
KOD NO	 mm	 mm	 mm	 mm	 mm	 mm	 mm	 kg
3805 RPR 100	100	35	131	43	22	50	250	
3805 RPR 125	125	40	159	41	22	50	300	
3805 RPR 150	150	45	181	44	22	50	350	









RPR		AĞIR TİP POLİAMİD TEKER RULMANLI							
KOD NO	 mm	 mm	 mm	 mm	 mm	 mm	 mm	 kg	
3805 RPR 100 F18	100	35	131	43	118	22	50	250	
3805 RPR 125 F18	125	40	159	41	118	22	50	300	
3805 RPR 150 F18	150	45	181	33.5	119	22	50	350	









SLP		GALVANİZ KAPLI SAC ÜZERİ SİYAH KAUKUK LASTİK KAPLAMA POLİAMİD BURÇLU						
KOD NO	 mm	 mm	 mm	 mm	 mm	 mm	 kg	
3805 SLP 100	100	35	131	43	22	50	100	
3805 SLP 125	125	40	159	41	22	50	130	
3805 SLP 150	150	45	181	44	22	50	160	
3805 SLP 170	170	45	198	47	22	50	170	









SLP		GALVANİZ KAPLI SAC ÜZERİ SİYAH KAUKUK LASTİK KAPLAMA POLİAMİD BURÇLU						
KOD NO	 mm	 mm	 mm	 mm	 mm	 mm	 kg	
3805 SLP 100 F18	100	35	131	43	118	22	50	100
3805 SLP 125 F18	125	40	159	41	118	22	50	130
3805 SLP 150 F18	150	45	181	33.5	119	22	50	160









SLP		GALVANİZ KAPLI SAC ÜZERİ SİYAH KAUKUK LASTİK KAPLAMA POLİAMİD BURÇLU						
KOD NO	 mm	 mm	 mm	 mm	 mm	 mm	 kg	
3805 SLP 170 F09	170	45	198	47	146	22	50	170











SLS		GALVANİZ KAPLI SAC ÜZERİ SİYAH KAUKUK LASTİK KAPLAMA MASURALI						
KOD NO	 mm	 mm	 mm	 mm	 mm	 mm	 kg	
3805 SLS 100	100	35	131	43	22	50	100	
3805 SLS 125	125	40	159	41	22	50	130	
3805 SLS 150	150	45	181	44	22	50	160	
3805 SLS 170	170	45	198	47	22	50	170	









SLS		GALVANİZ KAPLI SAC ÜZERİ SİYAH KAUKUK LASTİK KAPLAMA MASURALI						
KOD NO	 mm	 mm	 mm	 mm	 mm	 mm	 kg	
3805 SLS 100 F18	100	35	131	43	118	22	50	100
3805 SLS 125 F18	125	40	159	41	118	22	50	130
3805 SLS 150 F18	150	45	181	33.5	119	22	50	160



SLS		GALVANİZ KAPLI SAC ÜZERİ SİYAH KAUÇUK LASTİK KAPLAMA MASURALI						
KOD NO	 mm	 mm	 mm	 mm	 mm	 mm	 mm	 kg
3805 SLS 170 F09	170	45	198	47	146	22	50	170



C2UR		GÜÇLENDİRİLMİŞ POLİAMİD KASNAK ÜZERİ OVAL POLİÜRETAN KAPLAMA RULMANLI						
KOD NO	 mm	 mm	 mm	 mm	 mm	 mm	 mm	 kg
3805 C2UR 150	150	45	181	44	22	50	400	

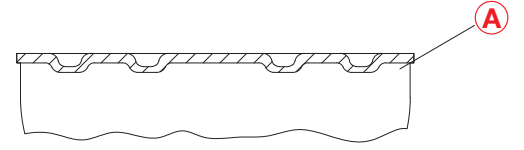
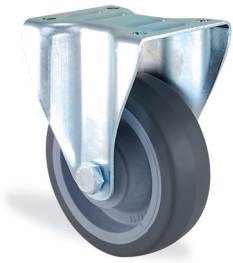
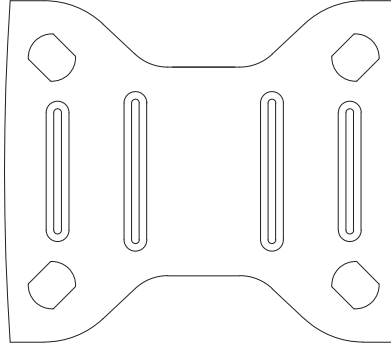

C2UR		GÜÇLENDİRİLMİŞ POLİAMİD KASNAK ÜZERİ OVAL POLİÜRETAN KAPLAMA RULMANLI						
KOD NO	 mm	 mm	 mm	 mm	 mm	 mm	 mm	 kg
3805 C2UR 150 F18	150	45	181	33.5	119	22	50	400

A: SABİT MAŞA

CTB		GÜÇLENDİRİLMİŞ POLIAMİD KASNAK ÜZERİ TERMOELASTİK KAPLAMA BURÇLU						
KOD NO	mm	mm	mm	mm	mm	mm	kg	
3807 CTB 100	100	35	133	105x85	80x60	12.5x9.3	120	
3807 CTB 125	125	40	162	105x85	80x60	12.5x9.3	150	
3807 CTB 150	150	45	184.5	105x85	80x60	12.5x9.3	180	









CTR		GÜÇLENDİRİLMİŞ POLIAMİD KASNAK ÜZERİ TERMOELASTİK KAPLAMA RULMANLI						
KOD NO	mm	mm	mm	mm	mm	mm	kg	
3807 CTR 100	100	35	133	105x85	80x60	12.5x9.3	120	
3807 CTR 125	125	40	162	105x85	80x60	12.5x9.3	150	
3807 CTR 150	150	45	184.5	105x85	80x60	12.5x9.3	180	









MLB		MOBLEN KASNAK ÜZERİ SİYAH DOLGU LASTİK KAPLAMA BURÇLU						
KOD NO	mm	mm	mm	mm	mm	mm	kg	
3807 MLB 100	100	35	133	105x85	80x60	12.5x9.3	100	
3807 MLB 125	125	40	162	105x85	80x60	12.5x9.3	130	
3807 MLB 150	150	45	184.5	105x85	80x60	12.5x9.3	150	









MMB		MOBLEN TEKER BURÇLU						
KOD NO								
	mm	mm	mm	mm	mm	mm	kg	
3807 MMB 100	100	35	133	105x85	80x60	12.5x9.3	150	
3807 MMB 125	125	40	162	105x85	80x60	12.5x9.3	170	
3807 MMB 150	150	45	184.5	105x85	80x60	12.5x9.3	190	
3807 MMB 170	170	45	200	105x85	80x60	12.5x9.3	230	





PPB		POLİAMİD TEKER BURÇLU						
KOD NO								
	mm	mm	mm	mm	mm	mm	kg	
3807 PPB 100	100	35	133	105x85	80x60	12.5x9.3	170	
3807 PPB 125	125	40	162	105x85	80x60	12.5x9.3	200	
3807 PPB 150	150	45	184.5	105x85	80x60	12.5x9.3	230	
3807 PPB 170	170	45	200	105x85	80x60	12.5x9.3	250	



PUB		POLİAMİD KASNAK ÜZERİ POLİÜRETAN KAPLAMA BURÇLU						
KOD NO								
	mm	mm	mm	mm	mm	mm	kg	
3807 PUB 100	100	35	133	105x85	80x60	12.5x9.3	180	
3807 PUB 125	125	40	162	105x85	80x60	12.5x9.3	250	
3807 PUB 150	150	45	184.5	105x85	80x60	12.5x9.3	400	









PUR		POLİAMİD KASNAK ÜZERİ POLİÜRETAN KAPLAMA RULMANLI						
KOD NO								
	mm	mm	mm	mm	mm	mm	kg	
3807 PUR 100	100	35	133	105x85	80x60	12.5x9.3	180	
3807 PUR 125	125	40	162	105x85	80x60	12.5x9.3	250	
3807 PUR 150	150	45	184.5	105x85	80x60	12.5x9.3	400	









PYB		POLİAMİD KASNAK ÜZERİ AĞIR TİP VULKANİZE SİYAH LASTİK KAPLAMA BURÇLU						
KOD NO								
	mm	mm	mm	mm	mm	mm	kg	
3807 PYB 100	100	35	133	105x85	80x60	12.5x9.3	120	
3807 PYB 125	125	40	162	105x85	80x60	12.5x9.3	150	
3807 PYB 150	150	45	184.5	105x85	80x60	12.5x9.3	180	









PYR		POLİAMİD KASNAK ÜZERİ AĞIR TİP VULKANİZE SİYAH LASTİK KAPLAMA RULMANLI						
KOD NO								
	mm	mm	mm	mm	mm	mm	kg	
3807 PYR 100	100	35	133	105x85	80x60	12.5x9.3	120	
3807 PYR 125	125	40	162	105x85	80x60	12.5x9.3	150	
3807 PYR 150	150	45	184.5	105x85	80x60	12.5x9.3	180	









RMB		AĞIR TİP MOBLEN TEKER BURÇLU						
KOD NO								
	mm	mm	mm	mm	mm	mm	kg	
3807 RMB 100	100	35	133	105x85	80x60	12.5x9.3	160	
3807 RMB 125	125	40	162	105x85	80x60	12.5x9.3	200	
3807 RMB 150	150	45	184.5	105x85	80x60	12.5x9.3	220	
3807 RMB 170	170	45	200	105x85	80x60	12.5x9.3	240	



RPB		AĞIR TİP POLİAMİD TEKER BURÇLU						
KOD NO								
	mm	mm	mm	mm	mm	mm	kg	
3807 RPB 100	100	35	133	105x85	80x60	12.5x9.3	250	
3807 RPB 125	125	40	162	105x85	80x60	12.5x9.3	300	
3807 RPB 150	150	45	184.5	105x85	80x60	12.5x9.3	350	
3807 RPB 170	170	45	200	105x85	80x60	12.5x9.3	370	









RPR		AĞIR TİP POLİAMİD TEKER RULMANLI						
KOD NO								
	mm	mm	mm	mm	mm	mm	kg	
3807 RPR 100	100	35	133	105x85	80x60	12.5x9.3	250	
3807 RPR 125	125	40	162	105x85	80x60	12.5x9.3	300	
3807 RPR 150	150	45	184.5	105x85	80x60	12.5x9.3	350	





SLP		GALVANİZ KAPLI SAC ÜZERİ SİYAH KAUÇUK LASTİK KAPLAMA POLİAMİD BURÇLU						
KOD NO								
	mm	mm	mm	mm	mm	mm	kg	
3807 SLP 100	100	35	133	105x85	80x60	12.5x9.3	100	
3807 SLP 125	125	40	162	105x85	80x60	12.5x9.3	130	
3807 SLP 150	150	45	184.5	105x85	80x60	12.5x9.3	160	
3807 SLP 170	170	45	200	105x85	80x60	12.5x9.3	170	

SLS
GALVANİZ KAPLI SAC ÜZERİ SİYAH KAÇUK LASTİK KAPLAMA MASURALI

KOD NO	 mm	 mm	 mm	 mm	 mm	 mm	 kg
3807 SLS 100	100	35	133	105x85	80x60	12.5x9.3	100
3807 SLS 125	125	40	162	105x85	80x60	12.5x9.3	130
3807 SLS 150	150	45	184.5	105x85	80x60	12.5x9.3	160
3807 SLS 170	170	45	200	105x85	80x60	12.5x9.3	170

C2UR
GÜÇLENDİRİLMİŞ POLİAMİD KASNAK ÜZERİ OVAL POLİÜRETAN KAPLAMA RULMANLI

KOD NO	 mm	 mm	 mm	 mm	 mm	 mm	 kg
3807 C2UR 150	150	45	184.5	105x85	80x60	12.5x9.3	400

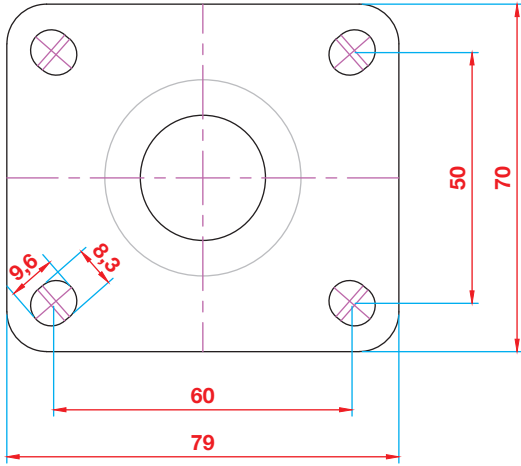

2402 TABLA

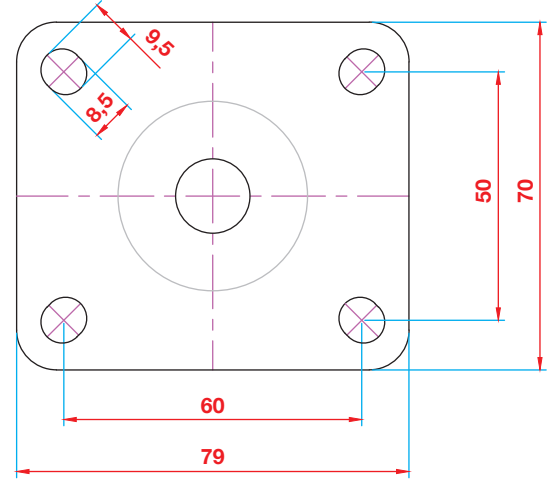

2502 / 2802 TABLA

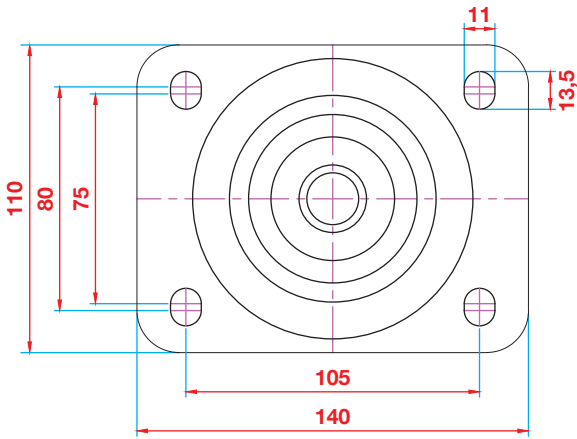

3202 / S3202 TABLA

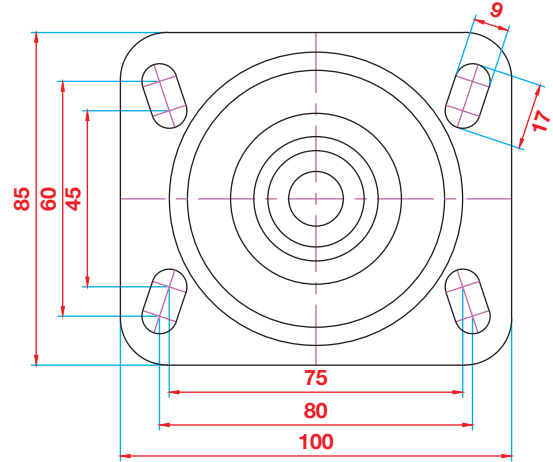

3302 / S3302 TABLA

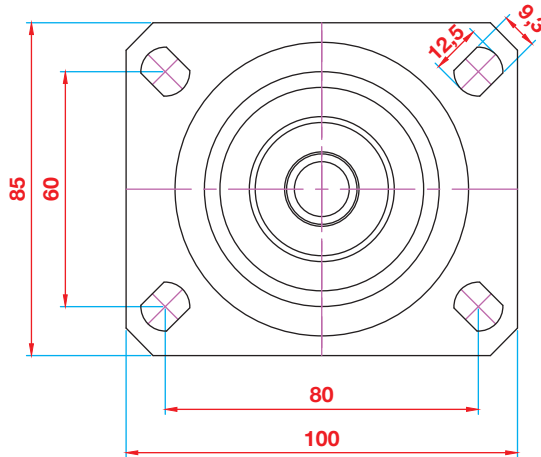

3802 TABLA



KAMA PRES SANAYİ ve TİCARET A.Ş.

Evren Mahallesi Gülbahar Caddesi No: 92
34212 Bağcılar - İSTANBUL - TURKEY

Tel: +90.212.655 21 00 PBX • Fax: +90.212.550 35 29
www.kama.com.tr • e-mail: satis@kama.com.tr



10/03/2016 - 1000 AD